

Whirlpool

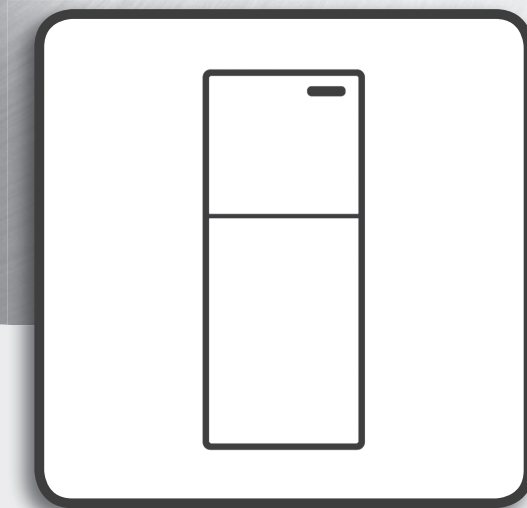

Health & Safety, Use & Care, Installation Guide and Online Warranty Registration Information

產品安全指引、使用說明、安裝指南及
網上登記保養資料

Model 產品型號：WF2T170



www.whirlpool.com.hk

尊敬的用戶：

感謝您使用惠而浦雪櫃，我們將竭誠為您提供無憂服務，方便您的居家生活。並請仔細閱讀本使用說明書，妥善保管，以備日後查閱、維修。因公司產品不斷改進，如有更改，恕不另行通知。

目錄

產品概述	雪櫃簡圖	1
------	------------	---

安全注意事項	安全標誌	2
	注意事項	2-4

產品介紹	搬運放置	5
	清潔保養	6

使用說明	使用準備	7
	開機	7
	溫度調節	8
	急凍室的溫度調節	8
	冷藏室的溫度調節	8-9
	照明燈	9
	除霜	9
	急凍室的使用	10
	製冰格	10
冷藏室的使用	11-12	

故障分析	非故障現象	13
	故障與排除	13-14

規格表	15
配件清單	16

雪櫃簡圖

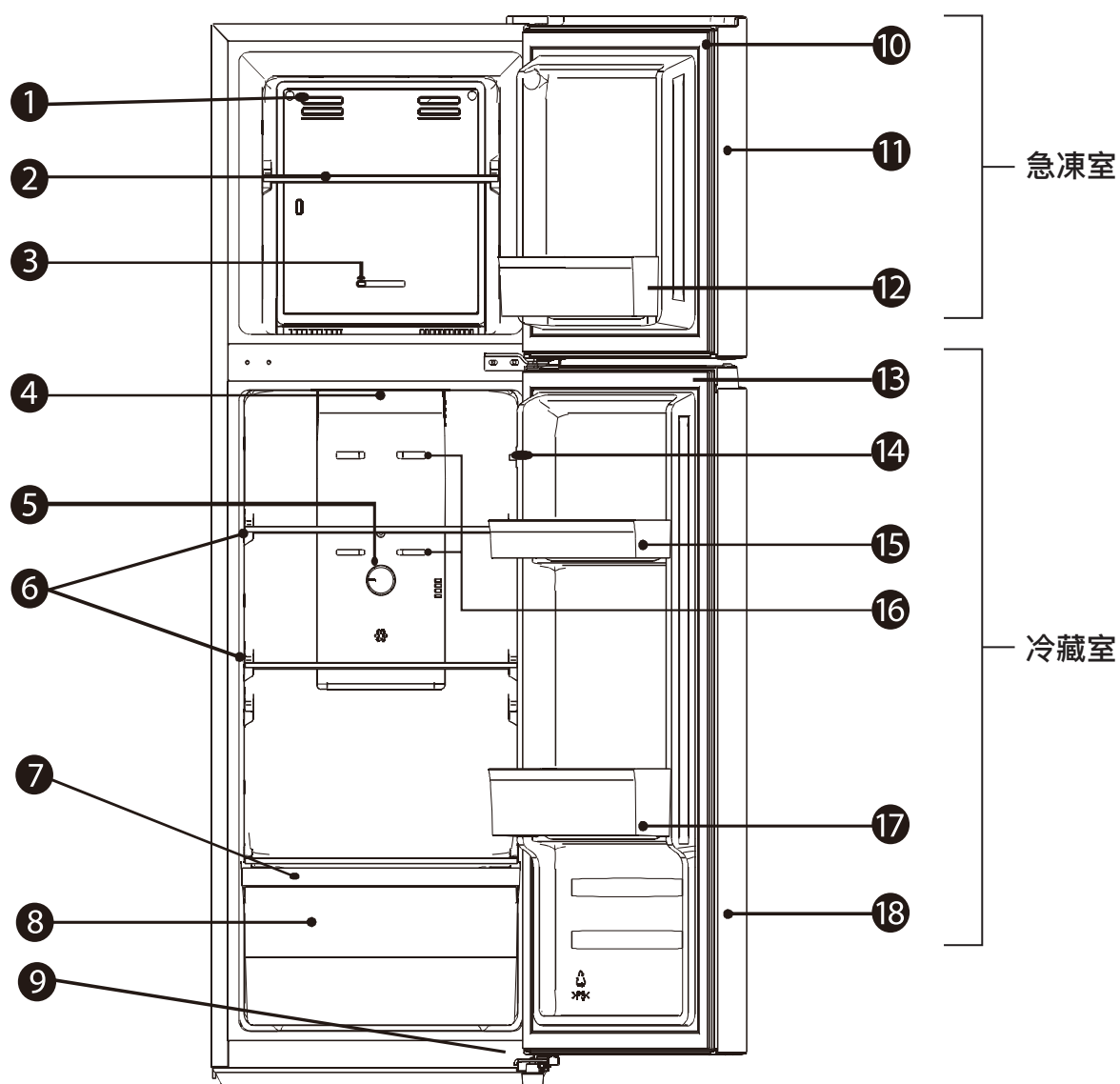





- | | |
|-------------|------------|
| 1. 急凍室風道 | 10. 急凍室門門封 |
| 2. 急凍室層架 | 11. 急凍室門 |
| 3. 急凍室溫度調節鈕 | 12. 急凍室門架 |
| 4. LED 照明燈 | 13. 冷藏室門門封 |
| 5. 冷藏室溫度調節鈕 | 14. 門開關 |
| 6. 冷藏室層架 | 15. 冷藏室上門架 |
| 7. 蔬果保鮮室層架蓋 | 16. 冷藏室風道 |
| 8. 蔬果保鮮室盒 | 17. 冷藏室下門架 |
| 9. 調節腳 | 18. 冷藏室門 |

註：
簡圖僅供參考。
產品說明書介紹不完全一致，但不會影響產品之性能及使用方法，請放心使用。



安全注意事項

安全標誌

 <p>禁止標誌</p> <p>此標誌的內容，是必須禁止的行為，否則可能會造成產品的損壞或危及使用者的人身安全。</p>	 <p>警示標誌</p> <p>此標誌的內容，必須嚴格按要求操作，否則可能會造成產品的損壞或危及使用者的人身安全。</p>	 <p>注意標誌</p> <p>此標誌的內容，是使用者必須引起重視的部分，否則可能會因操作不當引起產品損傷造成損失。</p>
 <p>此標誌的內容代表使用製冷劑時的注意事項。</p>		

注意事項

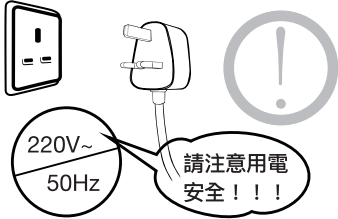
<p>本產品並不適宜由身體、感官或心智能力缺憾，或缺乏經驗和知識的人士(包括兒童)所使用，除非他們已獲得負責他們安全的人就使用本產品之監督或指導。</p> <p>請看顧好兒童，確保他們不會將這產品當作玩具。</p> <p>如果電源線損壞，必須由製造商，其服務代理商或相關部門的專業人員更換，以避免危險。</p> <ul style="list-style-type: none">- 警告：必須通風良好，確保器具周邊暢通無阻。- 警告：除製造商的個別建議以外，不要使用機械裝置或其他方式來加速除霜過程。- 警告：不要損壞製冷劑電路。- 警告：不要於雪櫃內使用其他電器設備，除非它們是由製造商推薦。- 警告：製冷劑和保溫發泡屬易燃物。棄置電器時請交至授權的廢物處理中心。請遠離火種。不要儲存爆炸性物質，如氣霧罐及對本產品易燃的推進劑。本產品只適用於家用或相關的應用，如：<ul style="list-style-type: none">- 在商店、辦公室和其他工作環境的員工廚房區；- 農舍、賓館、汽車旅館和其他住宅類型的環境；- 住宿附早餐供應的環境；- 餐飲及相類似的非零售應用。

<ul style="list-style-type: none">• 雪櫃使用的電源必須與規格表上列明的電源一致，並單獨使用標準三腳插座 (13A)，插座必須接地。• 若電壓波動範圍較大(超過 187~242V 的範圍)，有可能造成不啟動，控制板和壓縮機燒壞或壓縮工作異常等故障，此時必須加裝 750W 以上的自動穩壓器配合使用。	
<ul style="list-style-type: none">• 嚴禁私自拆卸、改造雪櫃，禁止損壞製冷管路。雪櫃故障時，請聯絡客戶服務中心。• 禁止使用易損壞的電線和插頭，容易導致火災，觸電的危險。• 如果電源軟線損壞，為避免危險，必須由製造商或其維修部或合資格技術人員來更換。	

- 切勿以拉扯電源線的方法拔出雪櫃的插頭。請抓緊插頭，從插座中直接拔出。
- 不要讓箱體壓住或人為踩踏電源線，不要讓電源線過分彎曲，手濕時禁止碰觸電源線和插頭，電源線破損或者剝落可能導致起火或觸電短路危險。
- 不要將電源線延長或接疊，電源線應與壓縮機保持距離，因為當雪櫃運作時，壓縮機表面的溫度會上升，否則絕緣會被減弱和會出現漏電情況。
- 更換損壞的 LED 照明燈及清潔、維修前，請拔去雪櫃的電源插頭。
- 如要更換 LED 照明燈，必須由製造商或其維修部之技術人員來更換。

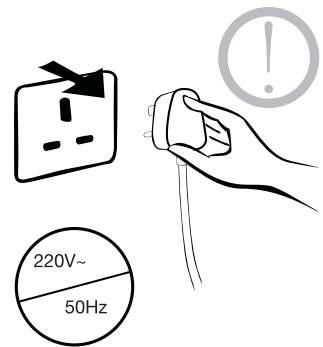

- 本產品為家用雪櫃，只適用於儲藏食品，不能保存對溫度管理有嚴格要求的物品。
- 如：醫藥用品、藥品、中藥材、血液、疫苗、菌種、研究標本、生化製劑及實驗室試驗品等不適合冰存的物品、易有變質的情況發生。
- 不可將乾冰置於本雪櫃內。



- 可燃氣體（液化石油氣、煤氣等）洩漏時，請勿觸摸雪櫃和電源插頭，應首先關好氣閥，開窗進行通風換氣；若馬上拔掉電源插頭會發生打火現象，可能引起火災、受傷等。
- 禁止打開雪櫃背面下部的後蓋，請勿將手伸進壓縮機，以免發生燒傷、觸電的危險。



- 本產品製冷劑為 R600a，使用時請遠離易燃易爆物品，如煤氣、塗料、汽油等。
- 安放地點必須通風良好，確保器具周邊或在嵌入式結構裡無阻礙物。禁止在雪櫃中存放酒精、汽油等易爆危險品及強腐蝕性的酸、鹼等，以防發生危險。
- 本雪櫃使用 R600a 製冷劑（雪種）和環戊烷發泡材料皆為易燃物料，廢舊雪櫃應遠離火源，不能燃燒處理。請交由合資格專業回收公司處理。以免對環境造成危害及發生其他危險。
- 製冷系統背後及雪櫃內均包含製冷劑液化石油氣。不要讓任何尖銳物體接觸到製冷系統。

製冷劑

製冷劑循環系統包含製冷劑 (R600a)，屬天然氣體，對環境不會造成傷害，但屬易燃物品。在運輸和安裝時，請確保製冷劑循環系統的所有組件均沒損壞。

製冷劑 (R600a) 屬易燃物品。



警告：火災 / 易燃物品風險

如發現製冷劑循環系統損壞：

- 避免打開火種。
- 確保所在地方通風。



- 雪櫃廢棄不用時，請將櫃門卸掉，拆下門封條及層架、抽屜等，並放置到合適的位置，以免小孩進入雪櫃玩耍，發生意外。
- 請勿在容易刮花的地板上使用腳輪來移動雪櫃，有可能刮花地板。
- 當要將雪櫃轉移到另一個位置並運往回收廠時，該使用說明書應交予將使用或處理雪櫃的人。



安全注意事項

- 雪櫃開始運作後，切勿用手觸摸急凍室的冰冷表面，尤其是手濕的時候，以免凍傷手。
- 在門與門之間以及門與箱體之間間隙很小，注意不要把手伸進這些區域內，以防夾傷手指。請輕力開關雪櫃門，以免物品掉落。
- 開關雪櫃門時，勿讓小孩靠近，以防發生夾傷危險。



- 不要用水噴淋、沖洗雪櫃，也不要將雪櫃放置在潮濕、易濺上水的地方，否則易造成生鏽、絕緣不良、漏電的危險。
- 不要在雪櫃頂部放置微波爐等重物，也不要放置電源插座、變壓器、熱水壺、電爐、點燃的蠟燭、魚缸等，禁止在雪櫃內部使用電器，以免發生意外。
- 請勿將重物置於雪櫃頂部，關門時容易造成掉落，引致危險。
- 停電或清潔時，應拔除電源插頭，確保相隔最少五分鐘後才可再次接通電源，以防連續啟動而損壞壓縮機。



- 請勿將玻璃瓶裝啤酒、飲料等放入急凍室，以防爆裂（特別是碳酸類液體）。
- 避免將食品放在玻璃層架邊緣，高度較高的食品會因拉出而傾倒，有掉落的危險。



- 有關包裝物料如包裝紙和發泡膠等可導致窒息！切記讓嬰孩遠離包裝物料。
- 不要吊在櫃門上玩耍，以防門體傾斜或門架拉壞，雪櫃傾倒造成人身傷害。
- 請勿讓兒童進入或攀爬雪櫃，避免小童被困於雪櫃內或因雪櫃倒下而受傷。
- 請特別注意老人、兒童的安全。若有老人或兒童要使用雪櫃時，需有成年人在旁監督指導及協助。因兒童有可能被困在雪櫃裡而發生窒息的危險。
- 避免兒童有單獨使用雪櫃的機會，防止兒童玩耍雪櫃，以免發生危險(如：碰傷、壓傷、窒息、觸電 等)。
- 若此電器被用作商業或作非冷藏用途，而出現任何損壞情況，生產商將不會負任何責任。



搬運放置

- 不可抓著門或者門把手來搬運雪櫃，應從底部抬起雪櫃。
- 雪櫃請勿倒置、橫放、擠壓、震動，搬動時傾斜不可大於 45°。
- 搬運前，請先將雪櫃內的物品及冷藏室玻璃層架取出，並將抽屜、蔬果保鮮室、門架等用膠帶固定好，關上櫃門並用膠帶封住，避免在移動過程中打開櫃門，以免櫃內物品及配件互相碰撞、摩擦、刮花、滑落造成人身傷害。
- 移動時請勿抓住櫃門或頂蓋，可將雪櫃稍向後傾(不可大於 20°)，利用後腳輪滾動進行短距離移動。
- 雪櫃需放置平坦堅固的地面，如需墊高，亦需選擇平穩、堅硬、不可燃的墊塊，切勿將雪櫃的包裝發泡膠墊塊用來墊高雪櫃。
- 遠離熱源，避免陽光直接照射。請勿放置在潮濕或有水賤的地方，防止生鏽或削弱絕緣效果。
- 應放置於通風良好的地方，雪櫃頂部應留有 10CM 或以上的空間，而兩側及背部與牆身距離需要 5CM 或以上。
- 為保障開門順暢及抽屜等物方便取出，請預留足夠空間。圖示尺寸僅供參考。
- 如果稍有不穩，可透過雪櫃底部的調節腳進行調整，順時針調高，逆時針調低。

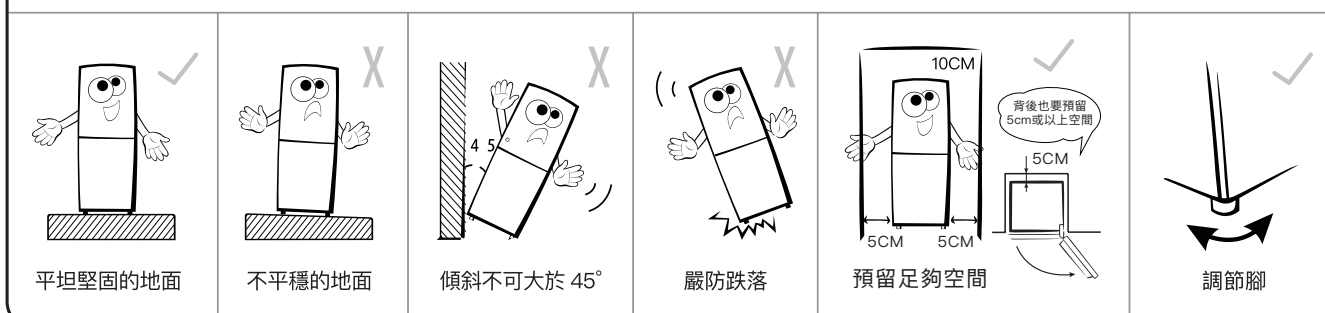

產品介紹

清潔保養

- 清潔前請拔掉電源插頭。
- 雪櫃背後及地面灰塵請按時清理，以提高散熱效果，同時利於節能。雪櫃內部應經常清潔以免產生異味。
- 取下所有門架、抽屜、蔬果保鮮室蓋等，用溫濕抹布擦乾淨。
- 將門封條取下用中性清潔劑仔細清洗，完畢後先將四角嵌入門槽中固定，然後逐段嵌入。
- 每隔一個月，對雪櫃清潔一次，使雪櫃內外保持清潔。
- 清洗前請先拔掉電源插頭，用溫濕抹布加少量中性清潔劑擦洗，再用清水擦淨，然後用乾抹布抹乾。
- 禁止用熱水、去污劑、酸鹼性洗滌劑、香皂、研磨粉、汽油、稀料、酒精、苯類有機溶液及刷子擦洗。
- 壓縮器如累積塵垢會增加電力消耗，因此請每年一次以軟毛掃或吸塵器小心清潔位於產品後的壓縮器。檢查位於雪櫃背壁的排孔。
- 雪櫃長時間停用，請拔掉電源插頭，將雪櫃清洗乾淨，晾乾內部，關閉櫃門時應留有適當的間隙，將雪櫃置於乾燥通風處。
- 停電時即使在夏季，食品仍可保存數小時。停電時應盡量減少開門次數，不宜再放入新鮮食品。

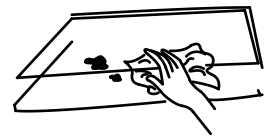

清洗玻璃層架

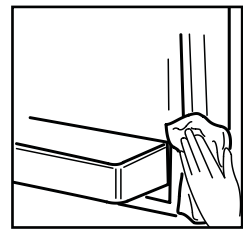

清洗門封條

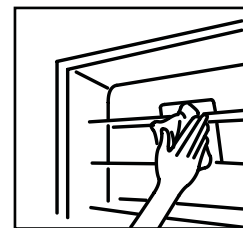

清洗雪櫃間室

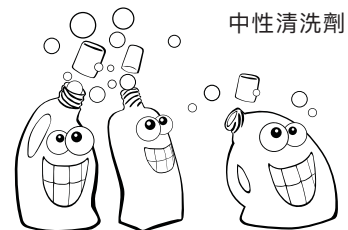

注意

- 不要使用硬毛刷、鋼絲刷、去污粉、有機溶劑 (例如汽油、香蕉水、丙酮等)、熱水或酸鹼等來清潔。
- 清潔時不要用水噴淋沖洗，以免影響電器絕緣性能。清潔“開關”和“照明燈”等電器零件的時候，請使用乾抹布。
- 雪櫃啟用後最好連續使用，一般情況下不要停用，以免影響雪櫃使用年限。

使用準備

- 拆除所有包裝組件，包括所有底座及固定配件用的膠帶。
- 清點隨機附件和資料，箱內物品請按配件清單內容對照檢查，如有出入，請向銷售商店查詢。
- 將雪櫃擺放到合適的位置，如有不平請透過雪櫃底部調節腳進行調整。
- 使用前建議先將雪櫃進行清潔，用海綿或柔軟的毛巾蘸取溫水進行擦拭。
- 雪櫃安放調平、清潔完畢後，先不要接通電源，讓雪櫃靜置 6 小時以上，再接通電源，以確保雪櫃正常運作。

開機

- 首次開機時，設置冷藏室及急凍室溫度調旋鈕至中間檔位。參考雪櫃結構圖，把配件放好。
- 接通電源，關閉櫃門，檢查壓縮機是否運轉。
- 開機半小時後，急凍室應有明顯的低溫感覺。通電 2~3 小時（夏天環境溫度高時需要 4 小時）後，再放入食品。

使用說明

溫度調節

溫度調節設置用於調節冷藏室和急凍室的溫度，通常應設置於中間的位置上。但也可根據需要，按下述方式來調節溫度。

冷藏室及急凍室的溫度調節是有相互關係的。例如：當調節急凍室溫度時，急凍室溫度調節鈕和冷藏室溫度調節鈕一起調節。

急凍室的溫度調節 (#)

- 當急凍室內不夠凍時，請把調節器推向“MAX”(最大)；過凍時，則把調節器推向“MIN”(最小)。



- 冷藏雪糕雪條時，溫度應設定在靠近“MAX”(最大)處。

冷藏室的溫度調節 (*)

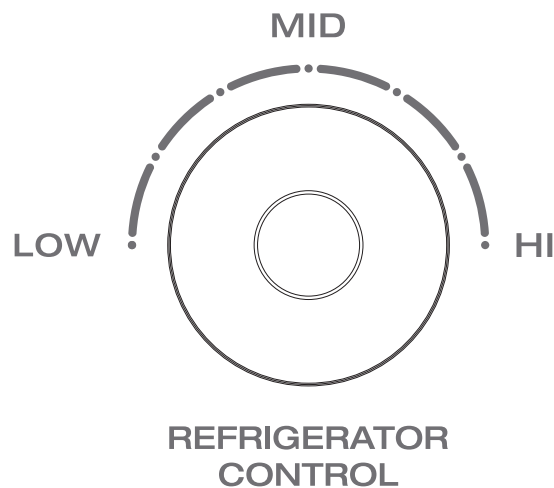

- 冷藏室內不夠冷時，請向“HI”(最高)旋轉；過冷時，則向“LOW”(最低)旋轉。
- 如果改變了冷藏室的溫度，蔬菜箱的溫度也會隨其變化。
- 1. 在普通冷藏情況下，急凍室溫度調節鈕 (#) 設置為“MAX”(最大) 與“MIN”(最小) 中間和冷藏室溫度調節鈕 (*) 設定為“MID”(中)。
- 2. 若需要把急凍室溫度調到較低時，把急凍室溫度調節鈕 (#) 設置在“MAX”(最大)，把冷藏室調節鈕 (*) 設定為“HI”(最高)。
(注意：一般在冷凍室儲存大量食物時使用)

- 3. 若需要把冷藏室溫度調到較低時，把急凍室溫度調節鈕 (#) 設置為“MAX”(最大)與“MIN”(最小)中間，把冷藏室溫度調節鈕 (*) 設定為“HI”(最高)。
(注意：一般在冷藏室儲存大量食物時使用)



注意

- 在一般情況下建議使用者設定在 (1.) 的模式下使用。
如果設置在 (2.) 或 (3.) 的模式下使用，建議不應該維持多於兩星期及應該盡可能回復到 (1.) 的模式，以達至最佳效能表現。

照明燈

- 冷藏照明燈為LED燈。若有異常，請聯絡客戶服務中心。

除霜

- 本產品帶有自動除霜功能，無需手動除霜，如風道面板上有霜，可用乾布抹拭。

使用說明

急凍室的使用

- 急凍室用於儲存急凍食品 and 製取少量冰塊等，要長時間急凍保存的食品應放在這個間室儲藏。

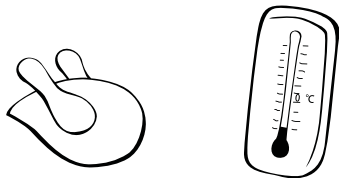

- 購買急凍食品後，要在食品尚未解凍的狀態下，盡快將其置於急凍室內進行急凍儲藏。

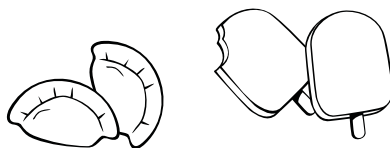

- 熱的食品放入急凍室前必須先冷卻至室溫。
- 熟食和生食應分開存放。
- 急凍室適宜存放肉類，魚蝦等食品。

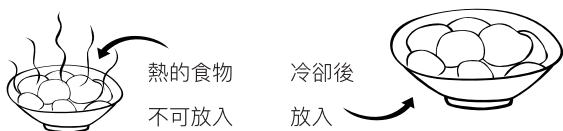

- 食品分小包裝按類存放，可方便存取、避免不必要的長時間開門，從而達到節能的目的，而且不易風乾或令氣味擴散。



- 蛋類、生葉類蔬菜、生薯類、乳製品、豆製品類不適合急凍保存。



- 存放食品時，要留有適當的空隙，否則會影響冷氣循環。

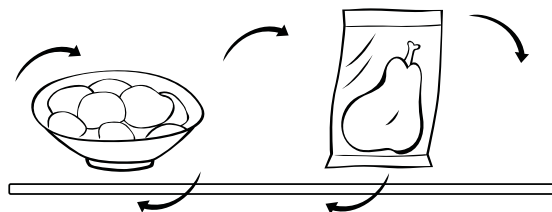

製冰格

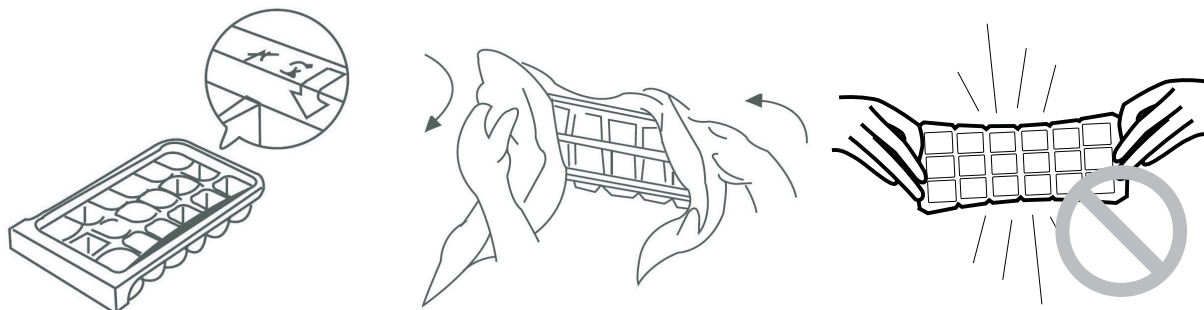

- 製冰格用於製作冰塊，注入五分之四容量的冷飲用水，置於急凍室，待冰格中的水結成實冰後，只需扭動冰格，就可使冰塊與冰格分離。但切勿折彎冰格，以免斷裂。
- 注意：如果很久才取出製冰盤，切勿直接用手握着製冰格，以免製冰格黏住皮膚，令雙手凍傷。

冷藏室的使用

- **門架**

適用於儲存雞蛋，罐裝液體，瓶裝飲料和包裝食品等，但不要把太多重的東西置於架中。而冷藏門的小門架可取出以進行清洗。

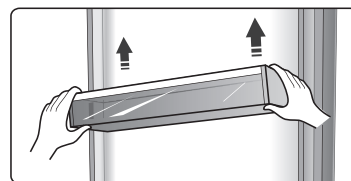

- 備註: 蛋架可放在最上的門架內。

- **層架**

在冷藏室的層架可以將它們直接取出以進行清洗。可按需要調節層架位置。

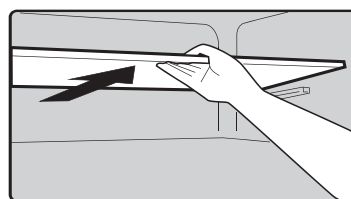

- **蔬果保鮮室**

蔬果保鮮室為伸縮式延伸安裝，用於存儲蔬菜和水果。

蔬果保鮮室層架蓋是用於控制蔬菜室的溫度及避免蔬菜失去水分。要拉出蔬果保鮮室時，請先清空保鮮室，然後向前推拉，再提起保鮮盒以脫離滑動軌並取出保鮮盒。

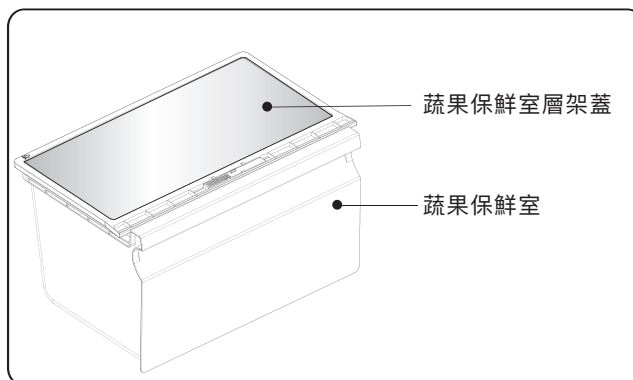

使用說明

冷藏室的使用

- 冷藏室用於儲存不需要急凍的食品和飲料，需短期儲藏的食品或隨時要吃的蔬果，請放在冷藏室。



- 儲藏蔬菜時應瀝乾蔬菜表面的水份，否則濕度過高不利於保鮮。
- 蔬菜抽屜蓋的作用是控制濕度，防止蔬菜水份流失。



- 熱的食品放入冷藏室前必須先冷卻至室溫。
- 熟食和生食應分開存放。



- 食品分小包裝按類存放，可方便存取、避免不必要的長時間開門，從而達到節能的目的，而且不易風乾或令氣味擴散。



- 香蕉、蜜瓜、菠蘿等溫熱帶水果不適合長時間冷藏儲存。

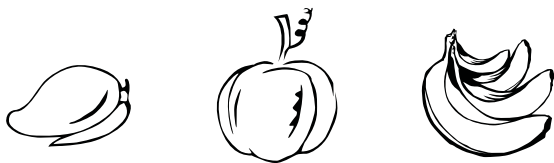

- 存放食品時，要留有適當的空隙，否則會影響冷氣循環。
- 玻璃層架可上下調整位置以達到合適儲存空間，方便使用。
- 切勿把太大或太重的食物放置在雪櫃內，否則將損毀層架及儲物架。

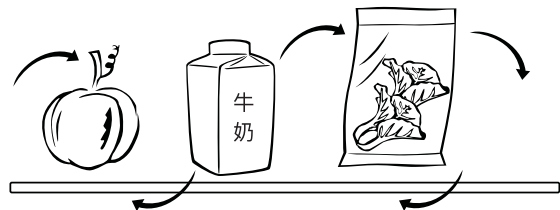

- 蘿蔔類應切掉葉子，防止營養被葉子吸收。
- 將急凍食品放在冷藏室解凍，這樣可以利用急凍食品的低溫來冷藏食品，達到節能的效果。
- 瓜類食品及香蕉、菠蘿等，在冷藏狀態下會促進其新陳代謝，不宜冷藏，但如果是未熟的水果，可在冷藏室保存一定時間，促其成熟。
- 有些食品如：洋蔥、大蒜、生薑、菱角、根莖類等，常溫下可以長時間保存，不需要放入雪櫃內冷藏。



注意

冷藏室的出風口儲存太多食物會阻礙空氣流動，引致雪櫃冷度不足。雪櫃中存放的食品特別是油類食品與內壁長時間接觸，會造成內壁腐蝕，應盡量避免食品與內壁直接接觸，當內壁沾上油污時，應及時輕擦乾淨。

非故障現象

- 雪櫃機身兩側及中樑處內部貼有冷凝管，工作時會向外散熱，溫度較高乃正常現象。
- 雪櫃首次使用時，櫃內溫度偏高，製冷時間會較長。
- 雪櫃製冷系統內的製冷劑在微細管內流速較高，有時會有流水聲。
- 環境濕度較高時，雪櫃門四周會有細微露水，屬正常凝露現象，可使用乾布抹拭。
- 嗡嗡聲：壓縮機工作時會發出嗡嗡聲，啟動或停機時會較大。
- 嗒嗒聲：電磁閥或電動切換閥會發出嗒嗒聲，屬正常現象。
- 雪櫃使用過程中，冷藏室會周期性結霜和除霜（除霜時冷藏室背部產生水珠），屬正常現象。
- 當關閉其中一道門，另外一道門是有可能因為風壓而打開。這是屬正常現象。

故障與排除

對下述故障，可以嘗試檢測，在聯絡客戶服務部前，請先檢查是否出現以下情況，從而找出解決方案。

故障	原因及排除
雪櫃不運作	<ul style="list-style-type: none"> • 電源是否接通，電壓是否過低，插頭是否牢固插好
製冷效果差	<ul style="list-style-type: none"> • 食品是否放置過多，過於擁擠 • 是否放入熱的食品過多 • 櫃門的開關是否過於頻繁或開門時間太長 • 雪櫃周圍有否足夠散熱空間（請參照第5頁建議） • 櫃門是否未關好或門封條有損傷、變形 • 是否擺放位置太接近爐具或被陽光照射
冷藏室食品結冰	<ul style="list-style-type: none"> • 冷藏室溫度設置過低 • 是否有較多食物靠近冷藏出風口或食物含過多水份
異常噪聲	<ul style="list-style-type: none"> • 地面是否平坦，雪櫃放置是否平衡 • 雪櫃是否碰到牆壁或其他物體 • 雪櫃配件是否放在正常位置 • 壓縮機倉內製冷管路是否互碰 • 櫃內的瓶子或容器在櫃內滾動的聲音

故障分析

故障	原因及排除
雪櫃發出異味	<ul style="list-style-type: none">• 有氣味的食品是否密封保存• 是否有變質食品• 雪櫃內部是否需要清潔
夏天高溫不停機	<ul style="list-style-type: none">• 是否放入熱的食品過多• 冷藏室的溫度調節制長期設置於“MAX.”(最大)• 櫃門的開閉是否過於頻繁或開門時間太長• 雪櫃外部通風不良，冷凝器散熱不充分• 櫃門是否未關好或門封條有損傷、變形• 夏季環境溫度高，長時間運作屬正常• 放入未冷卻食品
雪櫃門無法關上	<ul style="list-style-type: none">• 有雜物卡住門• 放入太多食品• 雪櫃歪斜
雪櫃內壁有露水	<ul style="list-style-type: none">• 環境溫度高，而雪櫃門長時間打開• 液體食物在存放時未有蓋好• 櫃門的開關是否過於頻繁或開門時間太長



注意

若問題仍未能解決，請勿自行拆開機殼及進行維修。應立即停止使用此產品，並與客戶服務中心聯絡。

產品型號	WF2T170
總有效容積 (L)	167
急凍室有效容積 (L)	36
冷藏室有效容積 (L)	131
氣候類型	ST
防觸電保護類別	I
冷凍星級	***
額定電壓 / 頻率	220-240V~50Hz
額定電流 (A)	0.8
能效等級	2
製冷劑及注入量 (g)	R600a (27g)
淨重 (kg)	38.5
外形尺寸 (W x H x D)(mm)	475 X 1441 X 557
建議使用所需空間 (W x H x D)(mm)	575 X 1541 X 607

因產品改進和技術更新，參數更新後，恕不另行通知，請以雪櫃背部規格標籤為準。

配件清單

產品型號	WF2T170
使用說明書	1
冷藏室強化玻璃防漏層架	2
冷藏室門架	2
蔬果保鮮室	1
蔬果保鮮室層架蓋	1
蛋架	2
急凍室強化玻璃防漏層架	1
急凍室門架	1
製冰格	1

雪櫃外觀、顏色和圖案請見實物。

由於產品改進，您所購買的雪櫃可能與產品說明書的介紹不完全一致，但不會影響性能和使用方法，請放心使用。

Dear User,

Thank you for choosing our products. We are sure you will find your new appliance is pleasure to use. Before using the appliance, we recommend that you read through these instructions carefully and retain for future reference. Design and specification may change due to product development, no prior notice will be given.

Content

Overview	Diagram	18
----------	---------------	----

Safety Instructions	Safety labels	19
	Safety notice	19-21

Product Introduction	Moving and placement	22
	Cleaning and maintenance	23

Using your Appliance	Preparation	24
	Power on	24
	Temperature Control	25
	Adjusting the freezer compartment temperature	25
	Adjusting the fridge compartment temperature	25
	Lighting	26
	Defrost	26
	How to use freezer compartment	27
	Ice Tray	27
How to use fridge compartment	28-29	

Failure Analysis	Non-failure analysis	30
	Trouble shooting	30-31

Specification	32
Accessories list	33

Overview

Diagram

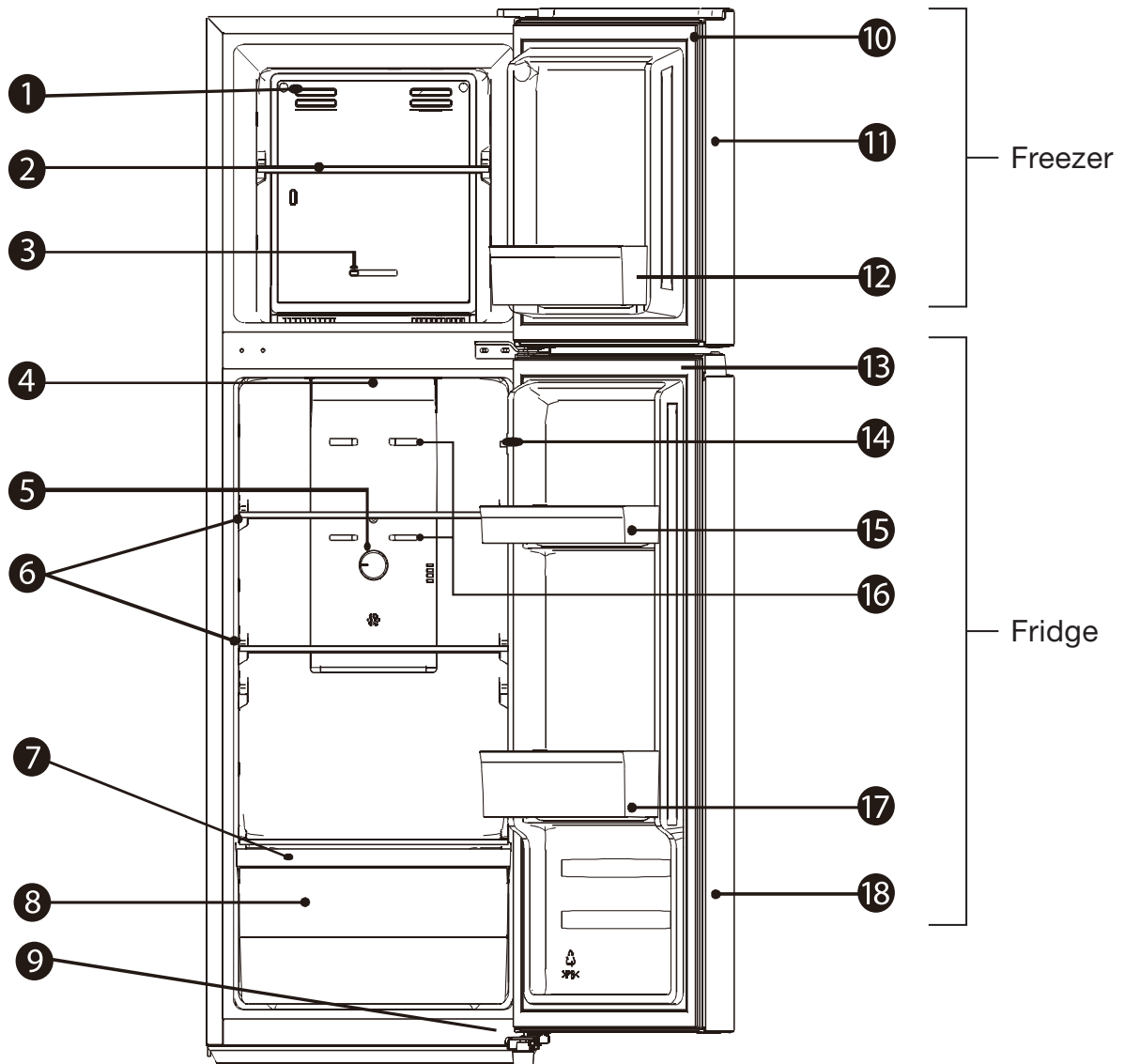





- | | | | |
|----|------------------------|-----|---------------------|
| 1. | Freezer wind channel | 10. | Freezer door gasket |
| 2. | Freezer shelf | 11. | Freezer door |
| 3. | Freezer temp. control | 12. | Freezer door rack |
| 4. | LED light | 13. | Fridge door gasket |
| 5. | Fridge temp. control | 14. | Door switch |
| 6. | Fridge shelf | 15. | Upper door rack |
| 7. | Crisper cover | 16. | Fridge wind channel |
| 8. | Crisper | 17. | Lower door rack |
| 9. | Adjustable bottom feet | 18. | Fridge door |

Note!

- Above drawing is for reference only.
- Due to unceasing modification of our products, the refrigerator may be slightly different from this instruction manual, but its functions and using methods remain the same.

Safety Labels

 <p>Prohibit mark</p> <p>This mark indicates the strictly prohibited behaviors which may cause product damage or injuries.</p>	 <p>Caution mark</p> <p>This mark indicates the user should strictly follow the operating instructions. Or it may cause product damage or injuries.</p>	 <p>Attention mark</p> <p>This mark indicates the issues that users must pay attention to. Or it may cause product damage or injuries.</p>
 <p>R600a</p> <p>This mark indicates the precautions on flammable refrigerant</p>		

Safety Notice

This appliance is not intended for use by persons (including children) with reduced physical, sensory or mental capabilities, or lack of experience and knowledge, unless they have been given supervision or instruction concerning use of the appliance by a person responsible for their safety. Children should be supervised to ensure that they do not play with the appliance.

If the supply cord is damaged, it must be replaced by the manufacturer, its service agent or similarly qualified persons in order to avoid a hazard.

- **WARNING:** Keep ventilation openings, in the appliance enclosure, clear of obstruction.
- **WARNING:** Do not use mechanical devices or other means to accelerate the defrosting process, other than those recommended by the manufacturer.
- **WARNING:** Do not damage the refrigerant circuit.
- **WARNING:** Do not use electrical appliances inside the food storage compartments of the appliance, unless they are of the type recommended by the manufacturer.
- **WARNING:** The refrigerant and insulation blowing gas are flammable. When disposing of the appliance, do so only at an authorized waste disposal centre. Do not expose to flame.

Do not store explosive substances such as aerosol cans with a flammable propellant in this appliance. This appliance is intended to be used in household and similar applications such as:

- staff kitchen areas in shops, offices and other working environments;
- farm houses and by clients in hotels, motels and other residential type environments;
- bed and breakfast type environments;
- catering and similar non-retail applications.



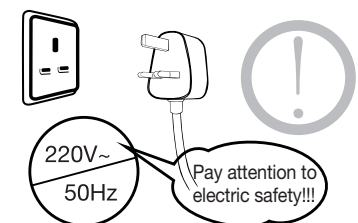

- Make sure the voltage specified on the rating labels corresponds to that of your home. It should operate on a separate UK plug (13A), and plug to an earthed outlet.
- If the voltage fluctuation range is high (beyond the range of 187 to 242V), it may cause abnormal run of the refrigerator or safety hazards. Automatic voltage regulator (above 750W) should be applied for safety use.

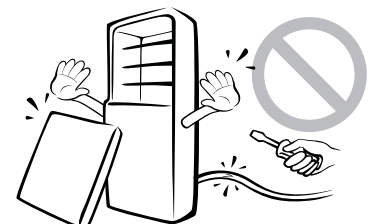

- Do not dismantle and transform the refrigerator or damage the cooling pipeline. If any failure on the machine, please contact customer service center.
- Do not use easily-damaged power cord or plug. It may cause fire or electric shock.
- If power cord is damaged, please contact customer service center or qualified personnel to repair or replace to avoid a hazard.

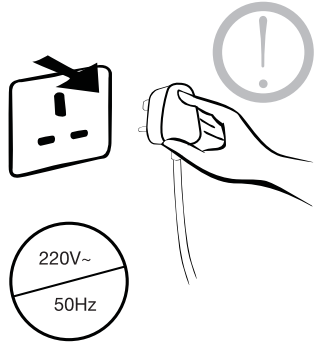

Safety Instructions

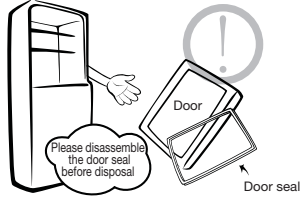
<ul style="list-style-type: none"> Do not unplug the appliance by pulling on the electrical cord. Always grip the plug firmly and pull straight out from the socket to prevent damaging the power cord. Make sure the power cord is not squashed, damaged or overly bended, and do not touch the power cord and plug with wet hands. Otherwise, it may cause short circuit, electric shock or overheated and even cause a fire. Do not extend or fold the power cord. Keep the power cord away from compressor because the temperature of the compressor surface would rise when it works. Otherwise the insulation would be weakened and current leakage would occur. Before repair, clean or replacement of the LED lamp, please disconnect the refrigerator from the main power. Replace the LED lamp, please contact professional worker or qualified personnel to repair, or replace. 	
<ul style="list-style-type: none"> This appliance is intended to use in household and store food only. Do not store any items with strict temperature requirement. Such as: medical supplies, medicines, Chinese herbal medicines, blood, vaccine, strains, research samples, biologics, lab supplies, etc., which are easy to go off. Do not store or place dry ice in the refrigerator. 	
<ul style="list-style-type: none"> When combustible gas (LPG, gas, etc.) leakage happens, do not touch the refrigerator and power cord. Turn off the gas valve and open windows for ventilation immediately. If immediately unplug the power cord, it may cause ignition and fire or damage. Do not open the refrigerator back cover or put hands into the machine room to avoid fire damage or electric shock. 	
<ul style="list-style-type: none"> This appliance contains R600a refrigerant, please keep away from flammable materials, such as gas, paint and gasoline, etc. The refrigerator should be placed in a location with good ventilation. Make sure the surrounding of the appliances around or the embedded structure shall not be obstructed. Do not store flammable materials (e.g. alcohol, gasoline, etc.), strong corrosive acids and alkalis to avoid danger. The refrigerator's R600a refrigerant and cyclopentane foam materials are combustible materials and discarded refrigerators should be isolated from the sources and can not be burned. Please transfer the freezer to qualified professional recycling companies for processing to avoid damages to the environment or other hazards. The refrigeration system behind and inside the refrigerator contains LPG refrigerant. Do not allow any sharp objects to come into contact with the refrigeration system. Refrigerant The refrigerant isobutene (R600a) is contained within the refrigerant circuit of the appliance, a natural gas with a high level of environmental compatibility, which is nevertheless flammable. During transportation and installation of the appliance, ensure that none of the components of the refrigerant circuit becomes damaged. The refrigerant (R600a) is flammable. <div data-bbox="177 1601 308 1715" data-label="Image"> </div> <div data-bbox="319 1641 505 1668" data-label="Text"> <p>Caution: risk of fire</p> </div> <p>If the refrigerant circuit should be damaged:</p> <ul style="list-style-type: none"> Avoid opening flames and sources of ignition. Thoroughly ventilate the room in which the appliance is situated. 	
<ul style="list-style-type: none"> Before disposing the refrigerator, please disassemble the door, door seals, shelves, drawers and place in a suitable location to avoid children climb inside and cause danger. Do not move refrigerator on the easy-to-damage floor to avoid scratching. The user manual should be handed over to any person who would use or handle the refrigerator whenever the refrigerator would be transferred to another location and delivered to a recycling plant. 	

Safety Instructions

- Do not touch the food or cans in the freezer with wet hands to avoid frostbite.
- The gaps between door and door or cabinet and door are very small, do not put hands into it to avoid pinching fingers. Please be gentle when switching off the refrigerator door to avoid falling articles.
- When open or close doors, do not allow children come close to avoid pinching.

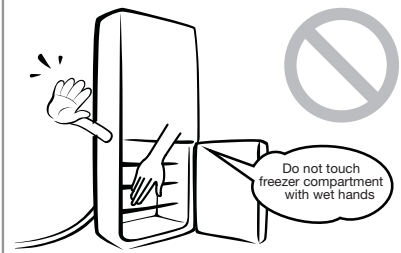

- Do not use water to spray or clean refrigerator. Do not put refrigerator into wet, easy-to-splash place to avoid rusting, bad insulation or electricity leakage.
- Do not put microwave oven, plug socket, voltage regulator, thermos, electric furnace, candles, fish tank, etc. on the top of the refrigerator. Do not use electric appliance inside the refrigerator to avoid danger.
- Do not place heavy objects on the top of the refrigerator considering that objectives may fall when close the door, and accidental injuries might be caused.
- Please unplug in case of power failure or cleaning. Do not connect the freezer to power supply within five minutes to prevent damages to the compressor due to successive starts.



- Do not put bottled or canned beers and drinks into freezer.
- Do not put food at the edge of the glass shelves. There is danger of falling when pulling out the food.



- Packaging (e.g wraps, polystyrene) can be dangerous for children. There is a risk of suffocation and keep packaging material away from children.
- Do not hang on the doors to avoid danger of tilt of cabinet or fall off of shelves.
- Do not allow children to enter or climb the refrigerator to prevent that children are sealed in the refrigerator or children are injured by the falling refrigerator.
- Please pay attention to the safety of elderly and children. When elderly and children need to use refrigerator, supervision of adult is needed. Children may be trapped in the cabinet and cause suffocation.
- Children should be supervised to ensure that they do not use the refrigerator alone to avoid danger(e.g. bruise, pressure injury, suffocation, electric shock).
- If you use the refrigerator in a commercial application or for purposes other than the cooling of food, the manufacturer is not liable for any damages that may occur.



Product Introduction

Moving and Placement

- Do not move the refrigerator with its doors or handles, please move by lifting up the bottom of it.
- Do not invert, horizontally lay, squeeze or vibrate the refrigerator. When move the refrigerator, do not decline more than 45°.
- In order to avoid appliances' damage or body injury, please remove all the parts and shelves, and seal the drawers, vegetable compartments, door shelves and doors with stickers, to ensure doors will not open and no parts collision, friction, falling during transportation.
- Do not grasp the doors or top cover when moving the refrigerator, but can tilt it back (no more than 20°), use trundles to move for a short distance.
- The refrigerator should be put on a flat and solid floor. The mat must be flat, solid, hard and fire-proof if the refrigerator needs to be put at a higher place. Please note that the bottom foam cannot be used as a mat.
- Keep away from heat and avoid direct sunlight. Do not place the freezer in humid or watery places to prevent rust or reduction of insulating effect.
- Refrigerator will be heated during operation. Please keep at least 5cm of space from the side to the wall, at least 5cm from the back to the wall, and at least 10cm from its top.
- Please leave enough space to ensure feasible opening and drawer removal. Dimensions shown are for reference only.
- If the refrigerator is not stable, adjusting the adjustable feet can fix the problem. The clockwise direction will increase the height and the counter clockwise direction will decrease the height.

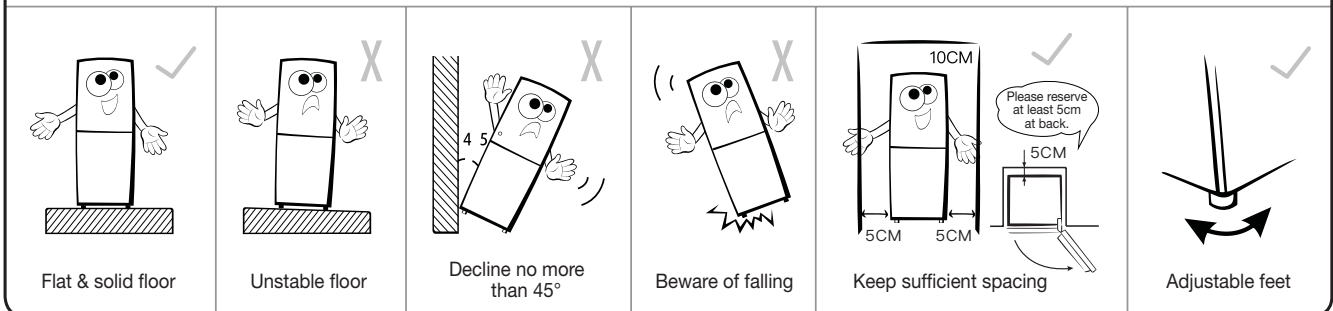

Cleaning and Maintenance

- Unplug or disconnect power before cleaning.
- Dusts behind the refrigerator and on the ground shall be timely cleaned to improve the cooling effect and energy saving. The interior of the refrigerator should be cleaned regularly to avoid odor.
- Remove all the door shelves, drawers and vegetable compartments, and clean them with wet cloth.
- Remove the door seal and clean it with neutral detergent. After cleaning, fix the seal in the four corners of the door slot, then embed the rest of the seal part by part.
- It is recommended to clean your refrigerator once a month.
- Unplug before cleaning, and use a wet cloth with neutral detergent to wipe the refrigerator and then use dry cloth to clean.
- Boiling water, eradicator, acid or alkaline detergent, soap, abrasive powder, gasoline, thinner, alcohol, benzene organic solution and brush are not allowed to use for cleaning.
- Accumulation of dust at the compressor increases energy consumption. For this reason carefully clean the compressor at the back of the appliance once a year with a soft brush or a vacuum cleaner. Check the water drain hold on the rear wall of the refrigerator compartment.
- If the refrigerator will not be used for a long time, please pull out the plug, clean and dry it. Leaving a little gap when close the door, and place the refrigerator in a dry and ventilated place.
- Food can be preserved for a couple of hours even in summer in case of power failure. In case of power failure, do not place food in refrigerator and reduce the times of opening the door.

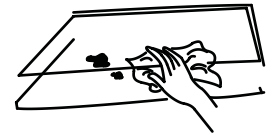

Clean the glass shelves

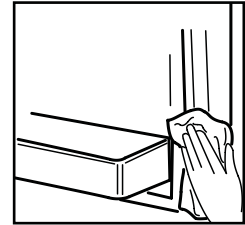

Clean the door seal

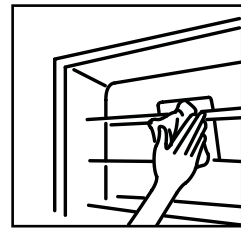

Clean the Refrigerator rooms

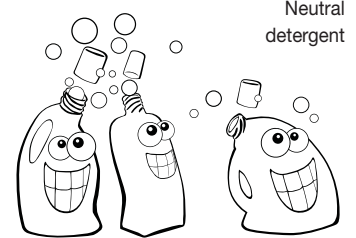

NOTICE

- Do not use a stiff brush, wire brush, scouring powder, organic solvents (such as gasoline, bananas water, and acetone, etc.), hot water, or acid or alkaline to clean.
- Do not rinse clean with water spray in order to avoid the weakening of the insulation. Use dry cloth to clean the switch and lamp inside the refrigerator.
- Continuous operation is recommended when the refrigerator is started. Please do not move the refrigerator under normal circumstances so as not to affect the refrigerator's service life.

Using your Appliance

Preparation

- Unpack all the packaging materials including the base and adhesive tape.
- Check the accessories and documents inside the package according to packing list, contact the shop from which you purchased if anything is missing.
- Put refrigerator in an appropriate place. If it is not stable, you may fix the problem by adjusting the adjustable feet.
- It is suggested to clean the refrigerator before usage.
- After installation and adjustment, wait for at least 6 hours before connecting the appliance to ensure the refrigerator can function normally.

Power On

- For first use, you need to turn the knob for both fridge and freezer to the middle. Put all the accessories in place according to the component diagram.
- Connect the refrigerator and close the doors, then check if the compressor works normally, and also check if the two sides of the refrigerator become heat (being heated is a normal phenomenon).
- The freezer should obviously cool down after the refrigerator works for half an hour. Put foods in the refrigerator after it starts for 2-3 hours (4 hours is needed if the room temperature is high in summer).

Temperature Control

- The temperature control knob for both the refrigerator and the freezer should usually be set at the middle position respectively. However, if necessary, the temperature can be adjusted as described below.
- During temperature adjustment, Freezer and Refrigerator controls must be adjusted together since they are inter-linked.

Adjusting the Freezer Compartment Temperature

- If the freezer compartment does not cold enough, pull the bar toward “MAX”. If the freezer compartment is too cold, pull the bar toward “MIN”.

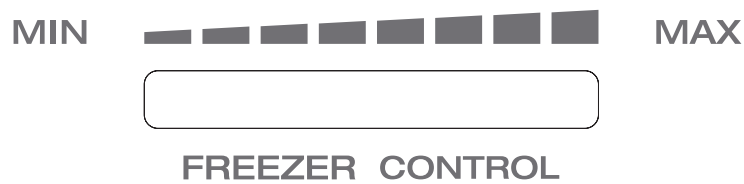

- When storing ice cream, the temperature should be set near “FREEZER MAX”.

Adjusting the Fridge Compartment Temperature

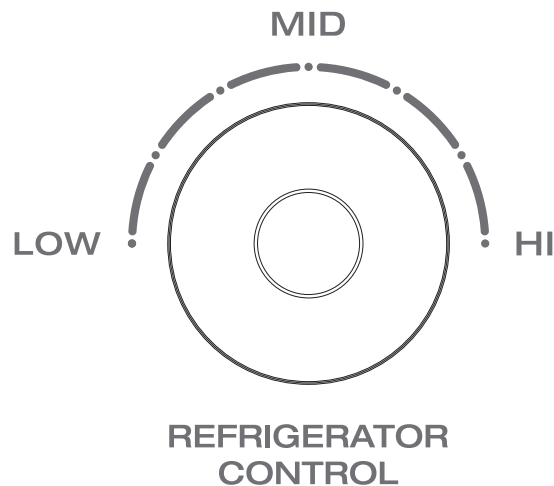

- If the refrigerator does not cold enough, turn the knob toward “HI”.
- Changing the fridge compartment temperature control also varies the temperature in the vegetable compartment.
- 1. For normal cold setting in both compartments, pull the control bar (#) in Freezer to the middle, between “MAX” and “MIN”, and set the control knob (*) in fridge compartment to “MID”.
- 2. For the maximum cold setting in Freezer, pull the control bar (#) in Freezer to “MAX”, and set the control knob (*) in fridge compartment to “HI”. (Remark: This setting is recommended to be set when tremendous food to be stored in Freezer.)

Using your Appliance

- 3. For the maximum cold setting in Fridge compartment, pull the control bar (#) in Freezer to the middle, between “MAX” and “MIN”, and set the control knob (*) in Fridge compartment to “HI”. (Remark: This setting is recommended to be set when tremendous food to be stored in fridge compartment.)



NOTICE

- It is suggested to have temperature setting at (1.) normal situation. If temperature setting (2.) or (3.) is used, it is suggested to have this setting less than 2 weeks and reset it to setting (1.) for better efficiency.



Lighting

- Lightings are LED lamp. If there are any abnormal issues, please contact customer service center.

Defrost

- This product has the function of automatic defrosting, so you don't need to do that manually. In case the frost exists in air flow panel, you can simply clean it with a cleaning rag.

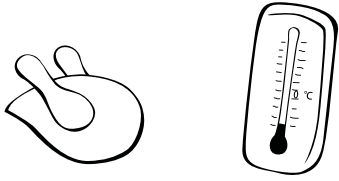
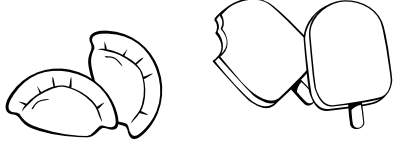
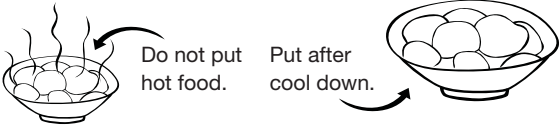
How to use the freezer compartment

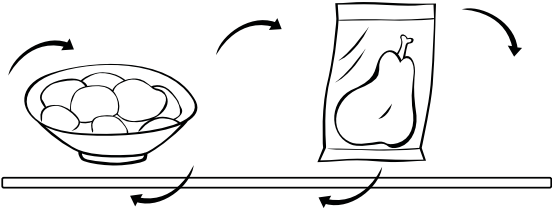
<ul style="list-style-type: none"> The freezer is used to store the frozen food and make ice. Foods that need to be frozen for a long period of time should store in this compartment. 	<ul style="list-style-type: none"> After buying the fast frozen food, it should be stored in the freezer before it unfreezes. 
<ul style="list-style-type: none"> Cooked food must be cool down to room temperature before putting into the freezer. Raw food must be stored separately with the cooked food. The freezing chamber is suitable for storage of meat, fish, rice balls and other foods not to be consumed in short term. 	<ul style="list-style-type: none"> Food stores in small package by category for easy access and avoid unnecessary prolonged door opening so as to achieve the purpose of energy saving. It can also help avoiding food dehydration and odor diffusion. 
<ul style="list-style-type: none"> Eggs, vegetables, potatoes, milk, bean products should not be stored in the freezer 	<ul style="list-style-type: none"> Leave enough room for food storage, or it will affect the circulation of cold air. 

Ice Tray

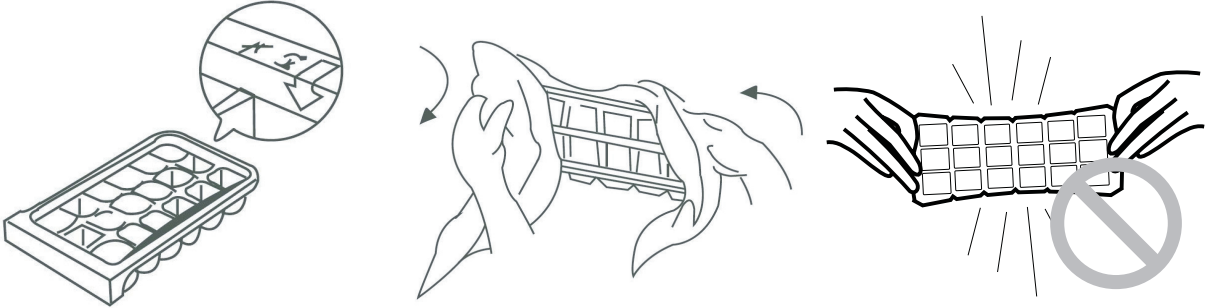

<ul style="list-style-type: none"> The ice tray is used to make ice. Pour water into 4/5 space of the tray and put the tray in the freezer. When the water becomes ice, it can be set apart from the tray by twisting the tray. Do not bend the tray to avoid breaking. Attention: If it takes a long time to make ice, please do not hold the ice tray directly to avoid the ice tray sticking and hurting your hands.

Using your Appliance

How to use the fridge compartment

- **Door rack**

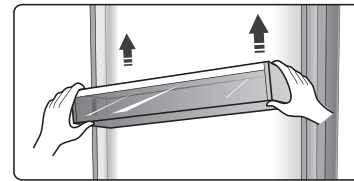
It is suitable for the storage of eggs, canned liquid, bottled drinks and packed food, etc. Do not place too many heavy things in the racks. The racks in the refrigerators can be taken out for cleaning.



- Note: Suggest to place the egg trays in the upper shelf.

- **Shelf**

There are shelves in refrigerator chamber, and they can be taken out for cleaning.

It can be adjusted at different position according to your requirements.

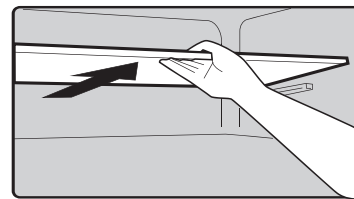

- **Vegetable Compartment**

The vegetable compartment, mounted on telescopic extension slides, is for storing vegetables and fruits. You can adjust the humidity inside by using the sliding block.

For its cover, it is for controlling the temperature of vegetable compartment and avoiding the vegetable from losing moisture.

When you remove the vegetable compartment, pull them forward, then lift it off the slides. Remember to empty food in the vegetable compartment firstly. Once you have removed the drawers, ensure the slides are pushed back fully.

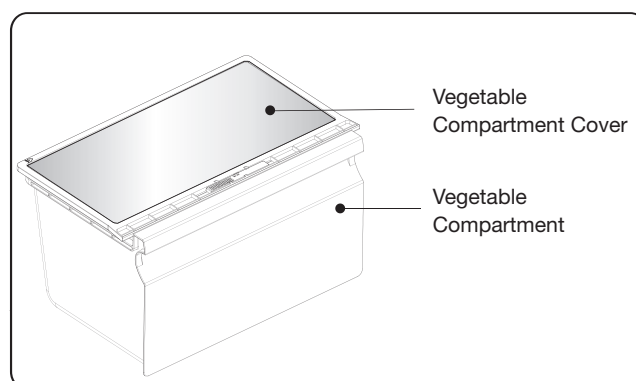

How to use the fridge compartment

- The fridge compartment is used for storing non-frozen food and beverage. Put the food and vegetables that you need to eat anytime or for short-time storage in this compartment.

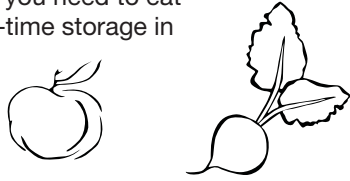

- Drain the vegetables thoroughly before storage, high humidity is not good for preservation.
- Vegetable compartment cover is for controlling the humidity in the drawer to keep vegetable moisture.



- Cooked food must be cool down to room temperature before putting into the fridge compartment.
- Raw food must be stored separately with the cooked food.

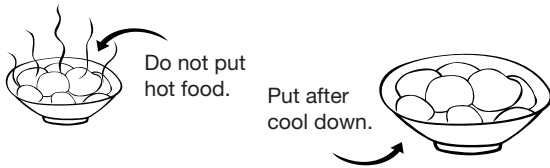

- Food stores in small package by category for easy access and avoid unnecessary prolonged door opening so as to achieve the purpose of energy saving. It can also help avoiding food dehydration and odor diffusion.



- Tropical fruits, like banana, melon and pineapple are not suitable for long term cooling.

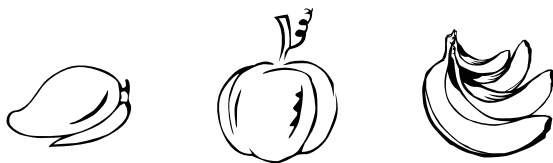

- Leave enough room for food storage, or it will affect the circulation of cold air.

- The glass shelves can be adjusted up or down for a reasonable amount of storage space and easy use.

- Do not put too bulky food in compartment or else it will damage shelves and door bins.

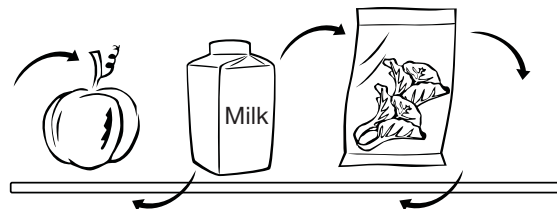

- Cut the leaves of the radish to prevent them absorbing the nutrition.
- Unfroze the frozen food in the fridge, can save some energy.
- Fruits are not suggested to be stored here since the fridge shall accelerate the process of metabolism. Otherwise the fruits are not immature, you can store them for some time.
- Some food such as onion, garlic, ginger, water chestnut, rhizome, you don't need to store them but just keep them outside.



NOTICE

Storing food at the outlet may block the air path and affect cooling performance.

The interior wall inside refrigerator will corrode after long time contact with food, especially oily food. It is suggested to keep the food away from the interior walls and clean if greasy dirt is found.

Failure Analysis

Non-failure analysis

- Both sides of the refrigerator has a condenser, it is a normal phenomenon to have heat dissipation during operation.
- The temperature is high inside the refrigerator during the first time operation, cooling time will be longer.
- Due to the high flow rate of refrigerant in the capillary within the refrigeration system, water running sounds may occur sometimes.
- When the humidity is high, it is a normal phenomenon to have dew appearing on the refrigerator surface and particularly near the door sealing.
- Buzz: Buzz will be generated by running compressor specially when starting up or shutting down.
- Clatter: The solenoid valve or electric switch valve will clatter which is a normal phenomenon and does not affect the operation.
- The refrigerating chamber will periodically frost and defrost (water drops will be generated on the backside of the refrigerating chamber when defrosting) which is normal.
- When closing one of the doors, the another one may be opened because of the air flow pressure, which is normal.

Trouble Shooting

For following troubles, check the possible cause and solution before calling for services.

Problems	Possible Cause & Solution
Refrigerator is not working	<ul style="list-style-type: none"> • Check if the power is connected; voltage is too low; power cord is firmly plugged
Cooling performance is not good	<ul style="list-style-type: none"> • Check if food storage is overcrowded • Check if there are too many cooked food stored • Check if the door opens frequently or open the door for too long • Check if dissipation space around the refrigerator is enough (Please refer to Page 28) • Check if the doors are shut properly or the door seal is damaged or deformed • Check if the placement too close to stoves or sunlight
Food in fridge compartment is frozen	<ul style="list-style-type: none"> • Check if fridge compartment temperature is set too low • Check if a lot of food placed too close to the back wall, or food is too moist
Abnormal noise	<ul style="list-style-type: none"> • Check if the floor is flat or the refrigerator is placed steadily • Check if refrigerator touches the wall or other objects • Check if all accessories are in right place • Check if refrigeration pipelines inside compressor touch each other • Bottles or containers fallen or rolling

Problems	Possible Cause & Solution
Odors from the compartments	<ul style="list-style-type: none"> • Check if food with peculiar smell kept with seal • Check if some food spoilages • Check if the interior needs to be cleaned
Non-stop operation during high temperature weather in summer	<ul style="list-style-type: none"> • Check if there are too many hot food stored • Check if temperature is set at “MAX” for long term • Check if door opens frequently or open the door for too long • Check if air cannot ventilate smoothly or condenser dissipation is not enough • Check if doors are not closed firmly or door seal is damaged / deformed • It is normal that refrigerator operates for longer time in summer when the ambient temperature is higher • Do not put food until they are cooled
The refrigerator door cannot be properly closed	<ul style="list-style-type: none"> • The freezer door is stuck by food packages • Too much food • Tilt refrigerator
Dew inside the cabinet	<ul style="list-style-type: none"> • Check if the ambient temperature is high and the door is spread for a long time. • Check if liquid food is not covered before storage. • Check if the door opens frequently or open the door for too long



NOTICE

If the problems still cannot be solved, please contact the service centre.

Specifications

Model No.	WF2T170
Total Storage Volume(L)	167
Freezer Volume(L)	36
Fridge Volume(L)	131
Climate Type	ST
Protection Against Electric Shock	I
Star Level Mark	***
Rated Voltage/Frequency	220-240V~50Hz
Rated Current(A)	0.8
Energy Efficiency Class	2
Refrigerant, Amount	R600a (27g)
Net Weight(kg)	38.5
Dimensions (W x H x D)(mm)	475 x 1441 x 557
Suggested Overall Space	575 x 1541 x 607
Required In Use (W x H x D)(mm)	

Design and specification are subjected to change without prior notice. Please refer to the rating label at the back of the refrigerator for details.

Accessories list

Accessories Name	WF2T170
Usual Manual	1
Fridge Tempered Glass Shelf	2
Fridge Door Bin	2
Vegetable Compartment	1
Vegetable Compartment Glass Shelf	1
Egg Tray	2
Freezer Tempered Glass Shelf	1
Freezer Freezer Door Bin	1
Ice Tray	1

The actual product outlook, color and patterns may differ from the graphics in user manual. But please be assured that it will not affect the performance and usage.

Register your product online

網上登記新產品保養

Save the planet and register your product warranty online!
Enjoy extra 1-month free warranty upon online registration.

「惠」環保出力，減少用紙！於網上登記產品更可獲額外多一個月保養。



<https://rebrand.ly/WPwarranty>

Whirlpool® Registered trademark/TM Trademark of Whirlpool group of companies

All rights reserved - <http://www.whirlpool.com.hk>

註冊商標/惠而浦集團的TM商標

版權所有 翻印必究 - <http://www.whirlpool.com.hk>



Whirlpool