

Whirlpool

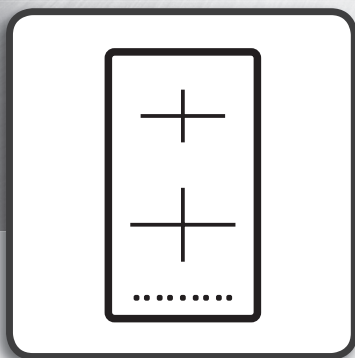

**Health & Safety, Use & Care, Installation Guide and
Online Warranty Registration Information**

Model: ACM230/IX



www.whirlpool.com.hk

INDEX

Safety precautions and warnings	3
Installation	11
Safety distances.....	13
Power cord.....	15
Wiring diagram	15
Description	16
Cooking zone information.....	17
Control description	17
Sensor keys.....	17
Cooking zone display.....	17
Timer display.....	17
Start and use	18
Commissioning.....	18
Booster Function.....	19
Switching off.....	20
Timer function.....	20
Operation.....	21
Troubleshooting	22
Cleaning and maintenance	25
Protecting the environment	26
Safety devices	27

SAFETY PRECAUTIONS AND WARNINGS

This hob is compliant with current safety regulations. Improper use can cause damage to property and/or to persons.

Read the operating instructions carefully before operating the hob as they contain important indications for installation, safety, use and maintenance of the appliance.

Observing them avoids dangers for persons and prevents damage to materials.

Keep the user instructions and hand them over to any other users.

Intended use

- This hob is intended for use in the home.
- It must always be used within the limits of the normal domestic environment, not within a professional or commercial context, to prepare and keep food warm. Any other use is not permitted.
- This appliance is not intended for use by persons (including children) with reduced physical, sensory or mental capabilities, or lack of experience and knowledge, unless they have been given supervision or instruction concerning use of the appliance by a person responsible for their safety.
- These persons can only use the appliance on their own if it has been clearly explained to them how it works, in order to use it safely. It is important that they know how to recognise and understand what dangers may derive from incorrect use of the appliance.
- Children should be supervised to ensure that they do not play with the appliance or nearby.

SAFETY PRECAUTIONS AND WARNINGS

Children

- Keep children under the age of eight away from the appliance; alternatively, supervise them at all times.
- Children over the age of eight may only use the hob on their own if it has been clearly explained to them how it works and if they are able to use it correctly. It is important to recognise and understand what dangers may derive from incorrect use of the appliance.
- Children must not carry out cleaning work on the hob without supervision.
- Supervise children in the immediate surroundings. The appliance in operation is very hot and remains hot for some time after it has been turned off. Keep children away from the appliance until it has cooled down completely. This will prevent the risk of being burned.
- Use the lock function to prevent children from turning on the appliance. When using the hob, activate the lock so that children cannot change the settings (selected).

Danger of asphyxiation!

Children can wrap themselves in the packaging material (e.g. in the film) or wrap it around their heads resulting in suffocation. Keep the packaging material away from children.

Danger of burns!

Keep items that could attract their attention out of the reach of children, placing them in compartments above or behind the hob.

SAFETY PRECAUTIONS AND WARNINGS

These objects could cause them to climb onto the appliance.

Danger of electric shock!

Do not start or immediately turn off the hob if the glass ceramic plate is damaged or cracked.

Disconnect the hob from the power supply

Technical safety

- Repairs or incorrectly performed installation and maintenance work can seriously endanger the user.
- Installation and maintenance work, as well as repairs, may only be carried out by qualified technician.
- Damage to the hob can compromise the safety of users. Check that there is no visible damage. Never use a damaged appliance.
- Electrical safety is only guaranteed if the hob is connected to a compliant earthing system. Make sure that this fundamental safety condition is verified. If in doubt, have the electrical system checked by a qualified technician.
- Do not use the hob in non-stationary locations (e.g. on ships)
- Contact with live parts or changes to electrical or mechanical structures can endanger the user and cause malfunctions in the hob.
- Never open the casing of the appliance under any circumstances. Multiple sockets or extensions is not allow do not guarantee the necessary level of safety (fire hazard).

SAFETY PRECAUTIONS AND WARNINGS

- For safety reasons, the hob must only be used after being installed. Consult this data before making the connection. In case of uncertainty, contact an electrician.
- The connection data (voltage and frequency) indicated on the data plate of the hob must fully correspond with that of the electrical mains, otherwise the appliance could become damaged.
- The appliance is not intended for operation with an external programmer clock or with a remote control system.
- The hob must be connected to the electric mains by an electrician. If a damaged power cord is replaced, a special power cord must be installed by an electrician.
- To carry out installation, maintenance or repair work, disconnect the hob from the power supply.

The appliance is only disconnected from the power supply if:

- the fuse of the electrical system is disabled or
- the fuses of the electrical system have been completely unscrewed, or
- the plug (if present) has been removed from the socket.

To remove the plug, always hold it; never pull the cord.

- If the hob is equipped with a communication module, make sure that the module is disconnected from the mains during installation, maintenance or repair work.
- The filter of a module contains components that remain charged after the main power supply has been removed. In the event of residual voltage, the filter components must discharge the voltage.

SAFETY PRECAUTIONS AND WARNINGS

Normally measuring devices can discharge the contacts. The discharge time typically takes around 1 minute.

Correct use

- Spray cans, slightly flammable liquids or combustible materials are flammable. Therefore, do not store lightly flammable objects in the drawers directly under the hob. The cutlery tray, if present, must be made of heat-resistant material.
- Do not heat empty pots or pans.
- Cookware must be placed directly on the glass ceramic and must be centred.
- Do not put anything between the pot and the glass (e.g. trivet).
- When cooking preserves or jars, closed jars can explode due to overpressure. Do not use the hob to prepare preserves or to heat jars.
- When covering the hob, there is a danger that the cover material will ignite, shatter or melt if the ignition is switched on or the residual heat is removed.
- Do not cover the hob, for example with cover plates, a cloth or protective film.
- If an electrical appliance is used in the immediate vicinity of the hob, for example a blender, make sure that the power supply cable does not come into contact with the hob. The insulation of the power supply cable may be damaged or melt.
- Metallic objects such as knives, forks, spoons and lids should not be placed on the hotplate since they can get hot.

SAFETY PRECAUTIONS AND WARNINGS

- If the hob has been fitted behind the door of a unit, only operate it with the unit door open.
- Close the unit door only when the residual heat indicators have turned off.
- The appliance in operation is very hot and remains hot for a certain time after it has been switched off. The risk of burns no longer exists only when the residual heat indicators are turned off.
- If the hob is very hot, there is a risk of being burnt. It is advisable to protect hands from heat by using special knobs or pot holders. Only use dry gloves or pot holders. Wet or damp fabrics are good heat conductors and may cause scalding.
- If the hob is on or has been inadvertently switched on, or in the event of residual heat, there is a risk that metal objects may overheat (danger of burns).
- Other types of materials could melt or ignite.
- Wet lids could stick to the hob due to the suction effect.
- Do not use the appliance as a support surface.
- Switch off the cooking zones after use.
- If sugar or food containing sugar, plastic or tinfoil ends up on the hot hob and they melt, they can damage the glass ceramic surface as they cool. Immediately turn off the hob and immediately remove these substances with a spatula. Wear gloves oven.
- Metallic objects such as knives, forks, spoons and lids should not be placed on the hob surface since they can get hot
- Danger of fire: Do not store items on the cooking surfaces

SAFETY PRECAUTIONS AND WARNINGS

- Clean the cooking zones with a glass ceramic cleaner as soon as they have cooled and resistand pot indicator is off.
- Pans from which liquids evaporate directly can damage the glass ceramic surface. Always remain in the vicinity of the appliance when it is operating.
- Pots and pans with a rough base may scratch the ceramic hob. Only use pots and pans with a smooth base.
- To move cookware it is always advisable to lift it off. This way the surface of the hob is not scratched.
- Salt, sugar or grains of sand, e.g. derived from cleaned vegetables, can scratch if they reach the base of the cooking cookware. Make sure that the glass ceramic surface and the base of the cooking cookware are clean before placing them on the hob.
- Light objects (e.g. a salt-cellar) that fall over can also crack or damage the glass ceramic plate. Caution: Do not drop any objects on the glass ceramic surface.
- Hot objects may damage the electronics under the sensor keys and indicator lights. Never place hot pots or pans on the sensor keys or on the indicator lights
- As the induction hobs heat very quickly, the temperature of the base of the pans can very quickly reaching the point of self-combustion for fats and oils. Always remain in the vicinity of the appliance when it is operating.

Greases and oils can be heated up in one minute and never use the Booster.

- CAUTION: the cooking process has to be supervised. A short term cooking process has to be supervised continuously
- WARNING: Unattended cooking on a hob with fat or oil can be dangerous and may result in a fire

SAFETY PRECAUTIONS AND WARNINGS

Warning for persons wearing pacemakers:

- Bear in mind that in the immediate vicinity of the appliance, when it is operating, an electromagnetic field is generated. The possibility of a pacemaker's operation being affected is very remote.
- If in doubt, contact the pacemaker manufacturer or your doctor.
- The electromagnetic field of the hob when on can compromise the operation of magnetisable objects.
- Credit cards, life-saving devices, pocket calculators etc. must not be found in the immediate vicinity of a hob when on.
- The appliance is equipped with a cooling fan. If there is a drawer underneath the recessed appliance, a sufficient distance must be observed between the contents of the drawer and the lower part of the appliance to ensure the necessary ventilation of the hob.
- Metal objects stored in a drawer under the appliance may become red hot if the appliance is used for a prolonged length of time. Do not store metal objects in a drawer located directly beneath the hob.
- Do not store small or pointed objects or paper in the drawer, as these could reach into the casing through the ventilation slots or could be sucked in and thus damage the fan or impair its cooling.
- Never use two pans on a single cooking zone.

INSTALLATION

General warnings

- **Installation and connection of the appliance can only be carried out by a qualified technician.** The manufacturer is not responsible for damage caused by incorrect installation or connection of the appliance. To prevent damage to the appliance, only recess it after installing the wall units and the extractor hood.
- The electrical safety of the appliance is only guaranteed if it is connected to a compliant earthing conductor. It is very important to verify that this condition is fulfilled as it is a fundamental premise. If in doubt, have the system checked by a specialist technician. The manufacturer is not responsible for damage caused by the absence or interruption of the earthing conductor.
- The appliance must not be connected to the mains with an extension cord; extensions do not guarantee the necessary safety of the appliance.
- The hob cannot be recessed above a dishwasher, a tumble drier, a washing machine, a refrigerator, a freezer, an oven or a cooker without a fan for cooling the appliance.
- On the one hand, partly high emission temperatures can damage these appliances, on the other ventilation of the hob is not guaranteed.

Only recess this hob on ovens or electric cookers equipped with a fume cooling system.

- If there is a drawer under the appliance, do not store flammable objects in it (e.g. spray cans).
- Make sure that the connection cable to the hob electrical system is not subjected to mechanical stress after installation (e.g. due to a drawer).
- The worktop veneers must be prepared with a heat-resistant adhesive (100°C) so that they cannot detach or become deformed. The end wall profiles must be heat-resistant.
- On one side and on the back side of a recessed glass ceramic hob there can be walls or furniture of any height, while on the other side any piece of furniture or appliance present must not be higher than the hob.

INSTALLATION

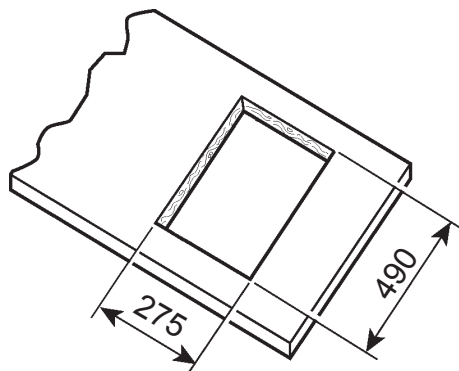

BUILT-IN DIMENSIONS (mm)

- Make the notch in the worktop according to the dimensions relative to the model (see figure above).

Respect the minimum distance of 50 mm towards the rear wall as well as to the right or left towards any side wall.

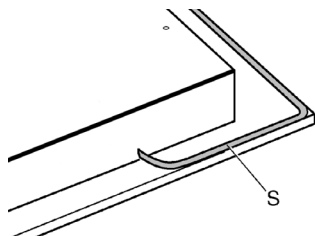

Turn the hob upside down and apply the seal supplied with the accessories kit to the outside edge evenly.

ATTENTION:

In order to ensure correct operation of the appliance, a gap of at least 5 mm must be left for the length of recessing on the front of the unit during installation.

This is because the electronic controls are equipped with a protection device which, **when the temperature of the electronic part exceeds 85°C, turns off the hob until it returns below this limit.** During operation then a fan comes on to guarantee the necessary air flow to avoid exceeding of the temperature limit.

Therefore provide the installation with an underlying protection that in any case guarantees a flow of air from the back of the unit or, if the hob is installed above an oven, a type of insulation that is adequate to ensure that this temperature is not exceeded. In the case of overtemperature, the electronic part may fail, for which the manufacturer declines all responsibility.

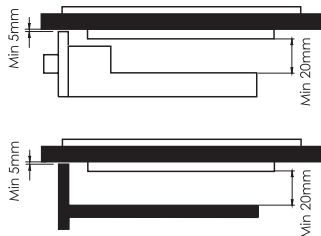

INSTALLATION

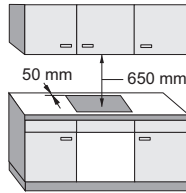

DISTANCE BETWEEN APPLIANCE AND EXTRACTOR HOOD

If the hob is installed below an extractor hood, the safety distance indicated by the manufacturer of the hood must be respected. In the absence of precise indications or if the appliance is fitted with highly flammable materials (e.g. a shelf), the safety distance must be at least 650 mm.

If several appliances are installed under the extractor hood, for which different safety distances are envisaged, observe the greater safety distance indicated.

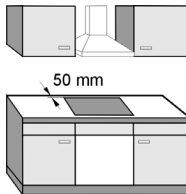

RECOMMENDED

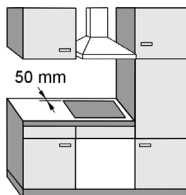

NOT RECOMMENDED

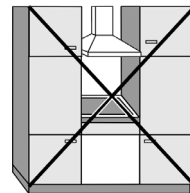

Safety distance to the sides/rear wall

When recessing a hob, on the back and on the side (on the right or on the left) there should preferably be unit or room walls (see images above)

- 50mm minimum safety distance on the back from the notch of the worktop to the rear edge of the same.
- 50mm minimum safety distance on the right and/or left side of the worktop notch to the adjacent unit (e.g. column unit) or to the wall

Intermediate shelf

The installation of an intermediate shelf under a cooking hob is not necessary but is permissible.

To lay an electrical power cord, prepare a 10mm distance on the back.

To allow better ventilation of the hob, it is advisable to leave a 20mm space.

INSTALLATION

Downward safety distance

To guarantee correct ventilation, it is necessary to maintain a minimum distance between the appliance and an oven, an intermediate shelf or a drawer.

The minimum distance between the lower edge of the hob and

- the upper edge of an oven must be 15mm
- the upper edge of an intermediate shelf must be 15mm
- the bottom of a drawer must be 75mm

Safety distance from the niche covering

If a covering is applied to the niche, a minimum distance must be observed between the worktop niche and the covering as high temperatures can damage or modify the materials.

If the covering is made of flammable material (e.g. wood), the minimum distance between the worktop and covering must be 50mm

If the covering is made of non-flammable material (e.g. metal, natural stone, ceramic tiles), the minimum distance between the worktop and covering notches must be 50mm less the thickness of the covering.

Example: covering thickness 15mm

50mm - 15mm = minimum distance 35mm

Electrical connection

The appliance can only be connected to the electrical network by a qualified electrician who is fully familiar with the general specific regulations of the local electricity company in force and who operates in compliance with the same.

Absorbed power

see data plate

Connection and protection

The necessary connection data is indicated on the plate and must correspond to that of the mains.

Determine the various connection possibilities from the relevant diagram.

Differential switch (circuit breaker)

For greater safety, it is advisable to include a circuit breaker with 30mA disconnection current

Separation devices

The device must be deactivated by means of disconnecting devices for each pole. (When the device is switched off, the contact opening must be at least 3mm). The disconnecting devices are overcurrent protections and protection switches.

Disconnect the appliance from the power supply

To disconnect the electrical circuit from the mains, after installation proceed as follows:

-**Fuses:** completely remove the fuses of the threaded caps or

-**Automatic protections:**press the control button (red) until the central button (black) or

INSTALLATION

Differential circuit breaker (circuit breaker): turn the main switch from 1 (on) to 0 (off) or press the control key.

After separation, make sure that there cannot be a connection to the power supply.

Power cord

The appliance must be connected by means of a H 05 VV-F type cable (PVC insulated) of suitable diameter, observing the connection diagram.

Determine the various connection possibilities from the relevant diagram.

The permissible connection voltage and the corresponding connection value are indicated on the data plate.

Replacing the power cord

If it is necessary to replace the power cord, please contact service centre.

Replacement of the cable must be performed by a specialist expert operating in compliance with the regulations in force and with the indications of the electricity supplier

The protective conductor must be screwed to the marked connection point 

Connection diagram

Y-TYPE CONNECTION



If the supply cord is damaged, it must be replaced by the manufacturer, its service agent or similarly qualified persons in order to avoid a hazard.

DESCRIPTION

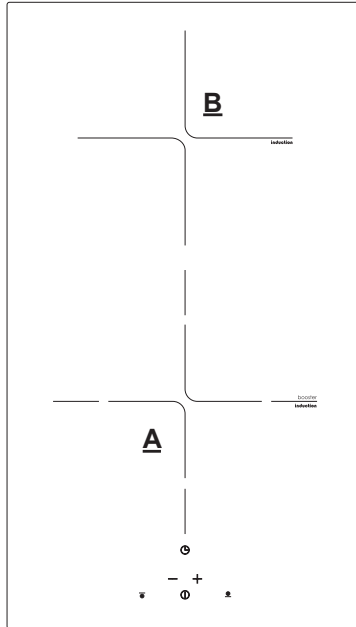

COOKING ZONE INFORMATION

OPERATION TIME LIMITATION

ZONE A

ZONE B

Level	Without Booster	3 kW Booster	1.4 kW
1	3.0	2.0	2.5
2	5.0	3.5	5.0
3	8.0	6.0	7.0
4	12.0	9.0	10.5
5	18.0	14.0	15.5
6	28.0	21.5	24.0
7	42.0	32.0	36.0
8	64.0	49.0	55.0
9	100.0	77.0	86.0
+P		100.0	

The cooking zone can also be switched off manually by bringing the power level to "0".

CONTROL DESCRIPTION

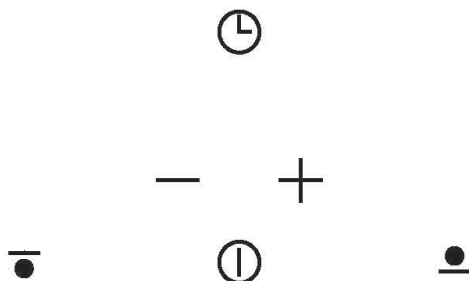

Sensors key

Ⓜ On/Off

- + Timer

- + Set the duration

1-9 Set the power level

Cooking zone display

0 = Cooking zone ready for operation

1-9 = Power level

+P = Booster

U = Cookware not placed on the hob or not suitable

H = Residual heat

Timer display

8.8.8 = Time in minutes

Ⓜ = Timer indicator light

● = Cooking zone symbol

START AND USE

Practical tips for use of the appliances.

- Use cooking containers whose manufacturing material is compatible with the principle of induction (ferromagnetic material). The use of these pots is recommended: in cast iron, enamelled steel or special stainless steel for induction. To make sure that a container is compatible, simply test it with a magnet.



- Use pots of sufficient diameter to completely cover the heating zone in order to guarantee exploitation of all the heat available.

SUITABLE MATERIAL

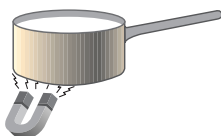

Cast iron, enamelled steel, special stainless steel with magnetic base

UNSUITABLE MATERIAL



Copper, Aluminium, Glass, Terracotta, Ceramic, Non-magnetic stainless steel



- Ensure the base of the cookware is always perfectly dry and clean to guarantee correct adherence and durability, both to the cooking zones and to the pots themselves.
- Avoid using the same pans used on gas burners: the concentration of heat on gas burners can deform the base of the pot, which loses adhesion.

In addition, to obtain the best performance from the hob:

- Use pots with a flat, thick base to ensure that they adhere perfectly to the heating zone.

First commissioning

First cleaning

- remove any protective and adhesive films
- before starting the appliance for the first time, clean it with a damp cloth and dry it

Commissioning

The metal components have been treated with a special protective product. At first start the appliance may emit odours and possibly steam. Even with the heating of the induction coils, odours may be given off during the first few hours of operation. With any further use the odour fades until it disappears completely. Smells and any fumes are not symptomatic of incorrect connection and damage to the appliance and are not harmful to health.

FIRST TIME USE

The hob is switched on by selecting the sensor of the control zone. When this sensor is selected, a sound is emitted.

Press the sensor key to turn it on. See photo below

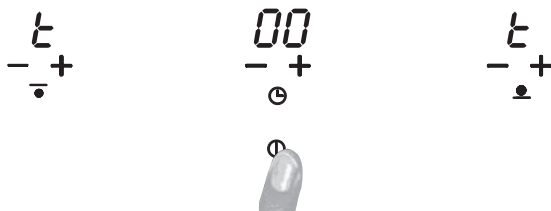

The heating zones turn on and all remain at "0" until a power level is selected. If this does not happen within 10 seconds, the hob switches off automatically.

With the appliance switched on, select the (+) key for the desired cooking zone which will be positioned at level 1. The maximum level that can be reached is 9, while with the sensor (-) the power is reduced to 0.

If the sensor (-) is activated with the selected level 0, the selected power will change to level 9. See photo below

The cooking zone can be deactivated by bringing the power level to "0". An acoustic signal sounds and the corresponding display shows "0"

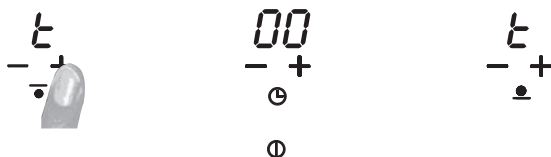

Booster function

Activation of the booster function

This function can be activated if the touch control is on, simply by pressing the booster sensor. This function consists of bringing power to maximum (position 10) for no more than 10 minutes, after which the power returns to the initial set level. The letter "P" appears on the display of the selected zone.

When the sensor is selected, a sound is heard and "P" appears on the display.

De-activation the booster function

This function can be cancelled at any time by selecting a temperature from 0 to 9 on the control panel. When this function is cancelled before the 10-minute period, a confirmation sound is heard and the new power selected is activated.

Indication of residual heat

When switching off a very hot cooking zone, the symbol H will appear on the display, indicating the residual heat.

The symbol will only switch off when the cooking zone is completely cold.

FIRST TIME USE

Timer function

The timer can be activated by pressing the corresponding sensors (+) and (-). Values between 1 and 59 minutes are selectable but they can be modified at any time. The seconds and minutes remaining until expiry are always displayed. To cancel the timer operation, press the (+) and (-) keys at the same time.

Activation of the Timer

When off, it can be activated by pressing the corresponding sensors (+) and (-) at the same time. A sound confirms power on and "0.00" appears on the display.



Timer operation with cooking zones

All the cooking zones can be controlled via the timer.

To operate the cooking zone with the timer, proceed as follows:

- activate the timer;
- select a cooking zone.
- within 10 seconds select the time to be programmed on the timer by pressing the - or + sensor keys. If this does not happen, the zone will switch off automatically.

Once the required time has elapsed, after 10 seconds the countdown for the selected cooking zone starts. The display of the timer and of the cooking zone stop flashing.



Switching off the appliance

Shutdown occurs by acting on the on/off sensor. When the hob is switched off, a sound is emitted and the symbol "H" appears on the power zones indicating either the residual heat or a possible fault.

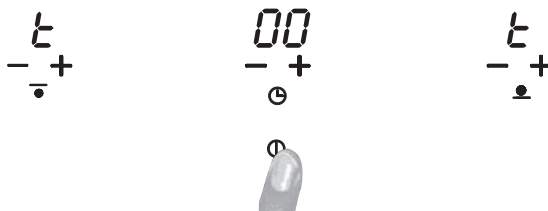

FIRST TIME USE

Changing the timer setting

When the timer is running, the previously programmed time can be changed at any time by pressing the (+) and (-) keys at the same time and then + or - to change the time. The countdown stops while waiting for the new setting.

End of timer countdown

When set time is finished, the displays of the relevant cooking zone and the timer start to flash. A sound is also heard notifying of the end of this function that remains active for 1 minute. The sound can also be stopped by pressing the (+) and (-) keys at the same time.

Switching off the timer

The timer can be stopped at any time by pressing the (+) and (-) keys simultaneously and then by setting the time to "0.00".



Operation:

Under each cooking zone there is an induction coil. If the cooking zone is on, it generates a magnetic field that reacts directly on the base of the pot and heats it. The cooking zone only heats indirectly due to the heat given off by the pot.

Induction only works if the cookware has a magnetic base. It automatically detects the dimensions of the positioned pot.

On the display of a cooking zone, the symbol U flashes if:

- the cooking zone is switched on without having previously positioned the cookware or if the cookware being used is not suitable
- the diameter of the base of the pot being used is too small
- the pot is moved from the cooking zone when on

PROBLEMS AND SOLUTIONS

ERROR MESSAGE	DESCRIPTION	POSSIBLE ERROR	TROUBLESHOOTING
C	The cooking zone can be configured if a "C" is displayed	No error, the user is in the service menu.	A pot must be on the relevant cooking zone.
C/-	The cooking zone is configured if a flashing "C" is displayed. After successful configuration the display shows "-"; if "-" is not displayed check the possible causes of the E/5.	The user is in the service menu, no error.	Wait for the "-" symbol or interrupt the configuration activities by pressing the "select" button and the "C" will no longer flash.
E	An "E" flashing on each cooking zone indicates that all the configurations will be deleted.	The user is in the service menu, no error.	Manual configuration
E / 2	The temperature limits are exceeded.	The temperature of the pan or glass is too high.	The system needs to cool down.
E / 3	Pot not suitable. Loss of magnetic characteristics due to the temperature on the base.	On the module a pot creates an improper operating point that can destroy the devices.	1-The error is cancelled automatically after 8 sec. and the cooking zone can be reused. In case of further errors on arrival the pot must be replaced. 2-The module must be changed if the error is given without a pot in the cooking zone.

PROBLEMS AND SOLUTIONS

ERROR MESSAGE	DESCRIPTION	POSSIBLE ERROR	TROUBLESHOOTING
E / 4	Induction module not configured (all the induction modules respond to the user interface but any element is related to the cooking zone chosen)	Induction module not configured	Remove the hob configuration and activate the manual configuration. Start the user interface service menu to configure the induction module. If the listed points have failed, replace the module.
E / 5	No communication between user interface and induction module.	No power supply of the induction module. Faulty wiring or defect.	Check the Power and cable connections. If the connection is OK, replace the module
E / 6	Main power supply problem.	Failure in the detection of frequency of main power. Overvoltage.	Check the voltage and frequency of the main power supply. If OK, replace the module.
E / 7	Unassignable error		Replace the module or user interface
E / 8	Fan fault	The fan or electronic control is faulty.	Replace the module.
E / 9	Defective temperature probe on the inductor.	Sensor signal outside the valid range. Defective sensor or electronics.	Replace the module.
E / A	Hardware defect of the induction module	Defect of the hardware device detected by the auto control of the module.	Replace the module
E / C	Configuration error	Two cooking zones are dedicated to the same element of the interface.	Delete the current configuration. Manual configuration with the service menu.

PROBLEMS AND SOLUTIONS

ERROR MESSAGE	DESCRIPTION	POSSIBLE ERROR	TROUBLESHOOTING
E / A	Hardware defect of the induction module	Defect of the hardware device detected by the auto control of the module.	Replace the module
E / C	Configuration error	Two cooking zones are dedicated to the same element of the interface.	Delete the current configuration. Manual configuration with the service menu.
E / H	Value of the fixed sensor.	Insufficient temperature change 5 min. after switching on of the hob.	The system needs to cool down.
No functionality and no display	Overvoltage on the power supply	400V connection	Disconnect and correct the power line connection

CLEANING AND MAINTENANCE

Danger of injury!

Steam from a steam cleaning appliance can reach voltage conductive parts and cause a short circuit.

NEVER use a steam appliance to clean a hob.

- always clean the hob after each use. Before doing so, allow it to cool completely.
- after cleaning, dry the appliance to avoid scale deposits.
- to avoid damaging the surfaces, DO NOT use the following cleaning products:
 - washing-up liquid,
 - detergents containing soda, ammonia, acids or chlorides,
 - anti-scale products,
 - products to eliminate stains and rust,
 - abrasive detergents, e.g. abrasive creams or powders, cleaning pastes, solvents,
 - dishwasher detergents,
 - sprays for grills and ovens,
 - glass cleaners,
 - abrasive brushes and sponges such as scourers or sponges that still contain residues of abrasive detergents,
 - dirt removing rubber,

Sharp objects

(to avoid damaging the seal between the glass ceramic plate and the frame or between the frame and the worktop)

- If the appliance is installed on an oven or an electric stove equipped with a pyrolytic system, do not operate it while the pyrolytic system is in progress as it may trigger the overheating protecting device of the hob.

CLEANING AND MAINTENANCE

For cleaning do not use detergent for dishes. With washing-up liquid not all residues and deposits can be removed. It creates an invisible film that discolours the glass-ceramic. These discolourations will then be impossible to remove.

Clean the hob regularly with a specific glass ceramic detergent.

Remove the largest pieces of dirt with a damp cloth;

Clean the surface of the hob with a suitable ceramic glass cleaner using kitchen paper or a clean cloth.

Finally, wipe the surface with a damp cloth and dry it. In subsequent cooking procedures, residues may stick to the surface and damage the glass ceramic.

Carefully remove all detergent residues.

Stains due to calcareous residues, water and aluminium residues (spots with metallic reflections) can be removed by using a specific glass ceramic and stainless steel cleaner.

Danger of burns

Wear oven gloves before removing any residues of sugar, plastic or aluminium foil with a spatula from the hot hob.

Immediately turn off the hob if sugar, plastic or aluminium foil are found on it while it is still hot.

Carefully remove these substances while they are still hot from the hob using a spatula.

Clean the cooking zone once cold as described above.

ENVIRONMENTAL PROTECTION

This product complies with Directive 2012/19/EU

The crossed bin symbol on the appliance indicates that the product, at the end of its useful life, needing to be treated separately from household waste, must be sent to a separate collection centre for electrical and electronic equipment or returned to the retailer at the time of purchase of a new equivalent appliance.



The user is responsible for taking the appliance at the end of its life to the appropriate collection facilities, otherwise incurring the penalties provided for by the current waste legislation.

Adequate separate collection for future use of the equipment assigned for recycling, treatment and environmentally compatible disposal helps to prevent possible negative effects on the environment and on human health and promotes recycling of the materials that compose the product.

For more detailed information regarding the collection systems available, contact the local waste disposal service or the store where the purchase was made.

Manufacturers and importers must comply with their responsibility for environmentally compatible recycling, treatment and disposal either directly or by participating in a collective scheme.

SAFETY DEVICES

ANTI-OVERHEATING DEVICES

All the induction coils and the electronic heat dissipater are respectively equipped with an overheating protection device.

Before the induction coils or heat dissipater can overheat, the overheating protection device ensures one of the following protection measures:

- if the Booster is on, it is deactivated.
- the power level set is reduced.
- the cooking zone switches off automatically. E2 appears on the display of the cooking zones

The cooking zone can be restarted when the fault message disappears.

If a second average temperature limit is exceeded, the induction reduces the power consumption to avoid a further increase in temperature.

The TC receives the information that there is a power reduction in operation but continues to show the unchanged settings that the user has chosen.

The overheating device can trigger if:

- cookware heats up without contents.
- oil or butter are heated at high power.
- the lower part of the appliance is not sufficiently ventilated.
- a very hot cooking zone comes on again after a power failure.

If the overheating protection device is triggered again despite elimination of the causes, contact technical support

Register your product online

Save the planet and register your product warranty online!
Enjoy extra 1-month free warranty upon online registration.



<https://rebrand.ly/WPwarranty>

Whirlpool® Registered trademark/TM Trademark of Whirlpool group of companies
All rights reserved - <http://www.whirlpool.com.hk>



Whirlpool