

Whirlpool

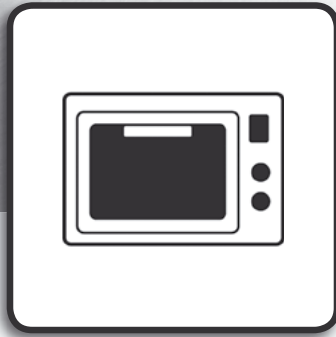

Health & Safety and **Use & Care** guide
產品安全指引及使用說明指南

Model 產品型號 : **MCP345**



www.whirlpool.com.hk

INDEX

INSTALLATION

- 3 Installation

SAFETY

- 4 Important safety instructions
- 5 Trouble shooting guide
- 6 Precautions

ACCESSORIES AND MAINTENANCE

- 7 Accessories
- 8 Maintenance & Cleaning

CONTROL PANEL

- 9 Control panel

GENERAL USE

- 10 Stand-by mode
- 10 Start Protection / Child Lock
- 10 Pause or Stop cooking
- 10 Add / Stir /Turn food
- 11 Clock

COOKING FUNCTIONS

- 12 Jet Start
- 13 Microwave
- 14 Grill
- 15 Combi Grill (Microwave + Grill)
- 16 Bread Defrost
- 17 Crisp

SPECIAL FUNCTIONS

- 18 Chef Menu

OPTIONS

- 19 Auto Clean

ENVIRONMENTAL HINTS

- 20 Environmental Hints
- 20 Technical Specifications

INSTALLATION

-PRIOR TO CONNECTING

Position the oven at a distance from other heating sources. For sufficient ventilation there must be a space of at least 30 cm above the oven.

The microwave oven shall not be placed in a cabinet. This oven is not intended to be placed or used on a working surface lower than 850 mm above the floor.

Check that the voltage on the rating plate corresponds to the voltage in your home.

Do not remove the microwave inlet protection plates located on the side of the oven cavity wall. They prevent grease & food particles from entering the microwave inlet channels.

Place the oven on a stable, even surface that is strong enough to hold the oven and the food utensils you put in it. Use care when handling.

Ensure that the space underneath, above and around the oven is empty to allow for proper airflow.

Ensure that the appliance is not damaged. Check that the oven door closes firmly against the door support and that the internal door seal is not damaged. Empty the oven and clean the interior with a soft, damp cloth.

Do not operate this appliance if it has a damaged mains cord or plug, if it is not working properly, or if it has been damaged or dropped. Do not immerse the mains cord or plug in water. Keep the cord away from hot surfaces. Electrical shock, fire or other hazards may result.

Do not use extension cord:

If the power supply cord is too short, have a qualified electrician or serviceman install an outlet near the appliance.

WARNING: Improper use of the grounding plug can result in a risk of electric shock. Consult a qualified electrician or serviceman if the grounding instructions are not completely understood, or if doubt exists as to whether the microwave oven is properly grounded.

-AFTER CONNECTING

The oven can be operated only if the oven door is firmly closed.

Poor television reception and radio interference may result if the oven is located close to a TV, radio or aerial.

The earthing of this appliance is compulsory. The manufacturer will accept no responsibility for injury to persons, animals or damage to objects arising from the non-observance of this requirement.

The manufacturers are not liable for any problems caused by the user's failure to observe these instructions.

IMPORTANT SAFETY INSTRUCTIONS

READ CAREFULLY AND KEEP FOR FUTURE REFERENCE

If material inside / outside the oven should ignite or smoke is emitted, keep oven door closed and turn the oven off. Disconnect the power cord or shut off power at the fuse or circuit breaker panel.

Do not leave the oven unattended, especially when using paper, plastic or other combustible materials in the cooking process. Paper can char or burn and some plastics can melt if used when heating foods.

WARNING: The appliance and its accessible parts become hot during use. Care should be taken to avoid touching heating elements inside the oven. Children shall be kept away unless continuously supervised.

The microwave oven is intended for heating food and beverages. Drying of food or clothing and heating of warming pads, slippers, sponges, damp clothing and similar may lead to risk of injury ignition or fire.

This appliance is not intended for use by persons (including children) with reduced physical, sensory or mental capabilities, or lack of experience and knowledge, unless they have been given supervision or instruction concerning use of the appliance by a person responsible for their safety. Children should be supervised to ensure that they do not play with the appliance. Keep the appliance and its cord out of reach of children.

WARNING: Do not use your microwave oven for heating anything in airtight sealed containers. The pressure increases and may cause damage when opening or may explode.

WARNING: The door seals and the door seal areas must be regularly inspected for damage. If these areas are damaged the appliance should not be operated until it has been repaired by a trained service technician.

Do not use your microwave oven for cooking or reheating whole eggs with or without shell since they may explode even after microwave heating has ended.

IMPORTANT SAFETY INSTRUCTIONS

The appliances are not intended to be operated by means of an external timer or separate remote-control system.

Do not leave the oven unattended if you are using a lot of fat or oil since they can overheat and cause a fire!

Do not heat, or use flammable materials in or near the oven. Fumes can create a fire hazard or explosion.

Do not use your microwave oven for drying textiles, paper, spices, herbs, wood, flowers or other combustible materials. Fire could result.

Do not use corrosive chemicals or vapors in this appliance. This type of oven is specifically designed to heat or cook food. It is not designed for industrial or laboratory use.

Do not hang or place heavy items on the door as this can damage the oven opening and hinges. The door handle should not be used for hanging things on.

TROUBLE SHOOTING GUIDE

If the oven does not work, do not make a service call until you have made the following checks:

- The Turntable and Turntable Support is in place.
- The Plug is properly inserted in the wall socket.
- The Door is properly closed.
- Check your Fuses and ensure that there is power available.
- Check that the oven has ample ventilation.
- Wait for 10 minutes, then try to operate the oven once more.
- Open and then close the door before you try again.

This is to avoid unnecessary calls for which you will be charged.

When calling for Service, please give the serial number and type number of the oven (see Service label).

Consult your warranty booklet for further advice.

If the mains cord needs replacing it should be replaced by the original mains cord. Please call service center regarding ong power cord. The mains cord must only be replaced by a trained service technician.

WARNING: Service only to be carried out by a trained service technician. It is hazardous for anyone other than a trained person to carry out any service or repair operation, it involves the removal of any cover, which gives protection against exposure to microwave energy.

Do not remove any cover.

PRECAUTIONS

- GENERAL

This appliance is intended to be used in household only.

The appliance should not be operated without food in the oven when using microwaves. Operation in this manner is likely to damage the appliance.

The ventilation openings on the oven must not be covered. Blocking the air intake or exhaust vents may cause damage to the oven and poor cooking results.

If you practice operating the oven, put a glass of water inside. The water will absorb the microwave energy and the oven will not be damaged.

Note: Please refer to the below sections "liquids".

Do not store or use this appliance outdoors.

Do not use this product near a kitchen sink, in a wet basement, or near a swimming pool, or similar.

Do not use the cavity for any storage purposes.

Remove wire twist-ties from paper or plastic bags before placing bag in the oven.

Do not use your microwave oven for deep-frying, because the oil temperature cannot be controlled.

Use hot pads or oven mitts to prevent burns, when touching containers, oven parts, and pan after cooking.

- LIQUIDS

E.g. beverages or water. Overheating the liquid beyond boiling point can occur without evidence of bubbling. This could result in a sudden boil over of the hot liquid.

To prevent this possibility the following steps should be taken:

1. Avoid using straight-sided containers with narrow necks.
2. Stir the liquid before placing the container in the oven and let the teaspoon remain in the container.
3. After heating, allow standing for a short time, stirring again before carefully removing the container from the oven.

- CAREFUL

After heating baby food or liquids in a baby bottle or in a baby food jar, always stir and check the temperature before serving. This will ensure that the heat is evenly distributed and the risk of scalding or burns can be avoided.

Always refer to a microwave cookbook for details. Especially, if cooking or reheating food that contains alcohol. Ensure the Lid and the Teat is removed before heating!

ACCESSORIES

GENERAL

There are a number of accessories available on the market. Before you buy, ensure they are suitable for microwave use.

Ensure that the utensils you use are oven proof and allow microwaves to pass through them before cooking.

When you put food and accessories in the microwave oven, ensure that they do not come in contact with the interior of the oven.

This is especially important with accessories made of metal or metal parts.

If accessories containing metal comes in contact with the oven interior, while the oven is in operation, sparking can occur and the oven could be damaged.

Always ensure that the turntable is able to turn freely before starting the oven. If the turntable isn't able to turn freely you should use a smaller vessel.

TURNTABLE SUPPORT

Use the Turntable Support under the Glass Turntable. Never put any other utensils on the Turntable Support.

- Fit the Turntable Support in the oven.

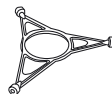

GLASS TURNTABLE

Use the Glass Turntable with all cooking methods. It collects the dripping juices and food particles that otherwise would stain and soil the interior of the oven.

- Place the Glass Turntable on the Turntable Support.



WIRE RACK

Use the high Wire Rack when cooking with Grill or Combi grill.



CRISP PLATE

Place the food directly on the Crisp Plate. The Crisp Plate may be preheated before use (max. 3 min.). Always use the Glass Turntable as support when using the Crisp Plate.

Do not place any utensils on the Crisp Plate since it will quickly become very hot and is likely to cause damage to the utensil.



CRISP HANDLE

Use the Crisp Handle to remove the hot Crisp Plate from the oven.



PLATE COVER (accessory sold separately)

The Cover is used to cover food during cooking and reheating with microwaves only and helps to reduce spattering, retain food moisture as well as reducing the time needed.

USE the cover for two level reheating.

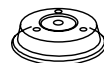

MAINTENANCE & CLEANING

Failure to maintain the oven in a clean condition could lead to deterioration of the surface that could adversely affect the life of the appliance and possibly result in a hazardous situation.

Do not use metal scouring pads, abrasive cleansers, steel-wool pads, gritty washcloths, etc. which can damage the control panel, and the interior and exterior oven surfaces. Use a cloth with a mild detergent or a paper towel with spray glass cleaner. Apply spray glass cleaner to a paper towel.

Do not use steam cleaning appliances when cleaning your microwave oven.

The oven should be cleaned regularly and any food deposits removed.

At regular intervals, especially if spill overs have occurred, remove the turntable, the Turntable Support and wipe the base of the oven clean.

Use a soft and damp cloth with mild detergent to clean the interior surfaces, front and rear of the door and the door opening.

Cleaning is the only maintenance normally required. It must be carried out with the microwave oven disconnected.

Do not spray directly on the oven.

This oven is designed to operate with the turntable in place.

Do not operate the microwave oven when the turntable has been removed for cleaning.

Do not allow grease or food particles to build up around the door. For stubborn stains, boil a cup of water in the oven for 2 or 3 minutes. Steam will soften the marks.

This product offers an **AUTO CLEAN** function, which allows for easy cleaning of the microwave cavity. For more details, please refer to the **AUTO CLEAN** section on page 19.

The Grill element does not need cleaning since the intense heat will burn off any splashes, but the ceiling beneath it may need regular cleaning. This should be done with a soft and damp cloth with mild detergent.

If the Grill is not used regularly, it should be run for 10 minutes a month to burn off any splashes, in order to reduce the risk of fire.

CAREFUL CLEANING:

The Crisp Plate should be cleaned in mild, detergent water. Heavily soiled areas can be cleaned with a scouring cloth and a mild cleanser.

Always let the Crisp Plate cool off before cleaning.

Do not immerse or rinse with water while the Crisp Plate is hot. Quick cooling may damage it.

Do not use steel-wool pads. This will scratch the surface.

DISHWASHER SAFE:

- Turntable Support
- Wire Rack
- Crisp Handle
- Glass Turntable
- Steamer
- Plate cover (accessory sold separately)

CONTROL PANEL

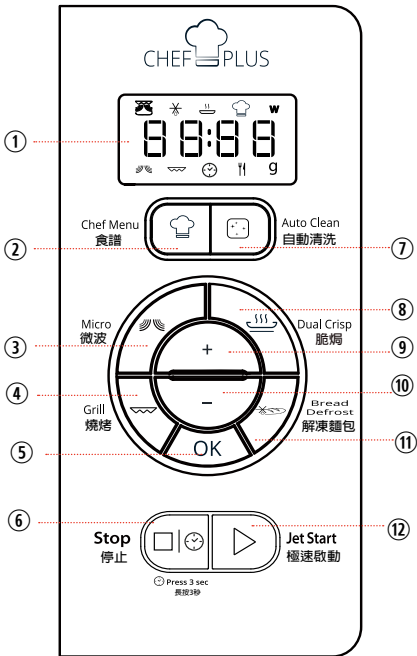

- 1 Display
- 2 Chef menu button
- 3 Microwave button
- 4 Grill button
- 5 OK button
- 6 Stop/Clock button
- 7 Auto Clean button
- 8 Dual Crisp button
- 9 Plus button
- 10 Minus button
- 11 Bread defrost button
- 12 Jet Start button



- 13 Crisp icon
- 14 Jet Defrost Menu icon
- 15 Jet Reheat Menu icon
- 16 Chef menu icon
- 17 Microwave power (watt)
- 18 Microwave icon
- 19 Grill icon
- 20 Clock setting / Time selection
- 21 Food type selection
- 22 Weight (grams)



STAND-BY MODE

The oven is in Stand-by mode when the clock is displayed (or, if the clock has not been set, when the display will show “:”).



START PROTECTION / CHILD LOCK

This automatic safety function is activated one minute after the oven has returned to “Stand-by mode”. When the safety function is active the door must be opened and closed in order to start the cooking, otherwise the display will show “door”.

door



PAUSE OR STOP COOKING

To pause cooking:

The cooking can be paused to check, turn or stir the food by opening the door. The setting will be maintained for 5 minutes.

To continue cooking:

Close the door and press the Jet Start button ONCE. The cooking is resumed from where it was paused.

If you don't want to continue cooking you can:

Remove the food, close the door and press the Stop button.

When the cooking is finished:

The display will show the text “End”. An acoustic beep will signal once a minute for 10 minutes, this is normal behaviour intended for cooling the product.

Depending on the product, the cooling fan or the internal lamp may continue to operate.

If desired, simply press the STOP button or open the door to cancel the signal and stop the cooling time. Please note that reducing or stopping this programmed cooling cycle will not have a negative impact on the functioning of the product.

Note: The oven will only hold the settings for 60 seconds if the door is opened and then closed after the cooking is finished.



ADD / STIR / TURN FOOD

Depending on the selected function, it could be needed to stir / turn food during cooking. In these cases the oven will pause cooking and it will ask you to perform the needed action.

When required, you should:

- 1 Open the door.
- 2 Add / Stir / Turn the food (depending on the required action).
- 3 Close the door and restart by pressing the Jet Start button.

Note: if the door is not opened within 2 minutes since the request to Add or Stir or Turn the food, the oven will continue the cooking process (in this case the final results may not be the optimal ones).



CLOCK

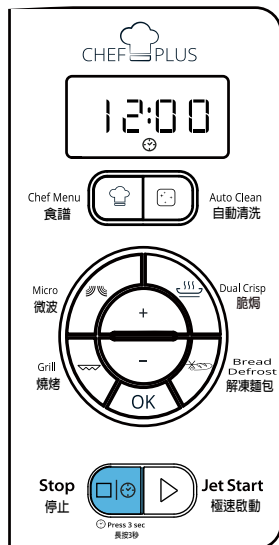

To set the Clock of your appliance:

- 1 Press & hold the Stop button for 3 seconds.
- 2 Press the Plus/Minus buttons to set the hours.
- 3 Press OK/Jet Start button. The minutes will start blinking.
- 4 Press the Plus/Minus buttons to set the minutes.
- 5 Press OK/Jet Start button. The clock is set.

Note:

The first time the appliance is plugged in (or after a power failure), the product will automatically enter the Clock Setting mode; in this case, please follow the above procedure starting from step No.2.

Tips and suggestions:

- If the clock has not been set after plug in, the clock will show "12:00".
- During the setting of the clock, if you press the Stop button or if the setting is not completed after a long time, the oven will exit from setting mode and the setting will be invalid, display will show ".".



JET START

This function allows to start the Microwave function at maximum power for 30 seconds. It is suggested for quick reheating of food with a high water content such as clear soups, coffee or tea.

- 1 Press the Jet Start Button.

Pressing the Jet Start button the Microwave function will start at maximum microwave power (800W) for 30 seconds.

Each additional pressing will increase the cooking time of 30 seconds.

If you have already selected a cooking function (e.g.: Grill), press Jet Start to start the selected function.

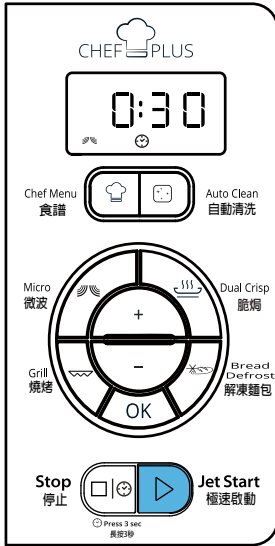

Tips and suggestions:

- It is possible to change the power level and the duration time even after the cooking process has been already started. To adjust the power level, simply press the Microwave button repeatedly. To change the duration time, please press the Plus/Minus buttons, or press the Jet Start button to increase the duration time of 30 seconds.



MICROWAVE

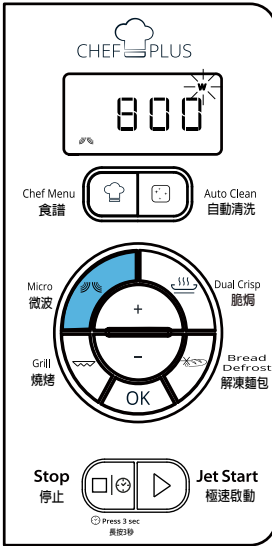

Microwave function allows to quickly cook or reheat food and beverages.

Suggested
Accessory:

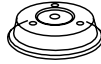

Plate Cover
(sold separately)

- 1 Press the Microwave button. The maximum power level (800 W) will be shown on the display and the watt icons starts blinking.
- 2 Press Plus/Minus buttons to set the power.
- 3 Press the OK button to confirm.
- 4 Press Plus/Minus buttons to set the cooking time.
- 5 Press the OK/Jet Start button. The function will start.

Once the cooking process has been started:

- To adjust the power: first press the Microwave button then press the Plus/Minus button to adjust the value.
- To increase time/decrease time: press the Plus/Minus buttons, or press Jet Start button to increase the cooking time of 30 seconds.

POWER	SUGGESTED USE:
800 W	Reheating of beverages, water, clear soups, coffee, tea or other food with a high water content. If the food contains egg or cream choose a lower power.
650 W	Cooking of fish, meat, vegetables etc.
500 W	More careful cooking e.g. high protein sauces, cheese and egg dishes and to finish cooking casseroles.
350 W	Simmering stews, melting butter.
160 W	Defrosting.
90 W	Softening ice cream, butter and cheeses. keep warming.



GRILL

This function uses a powerful grill to brown foods, creating a grill or a gratin effect.

Grill function allows to brown foods like cheese toast, hot sandwiches, potato croquettes, sausages, and vegetables.

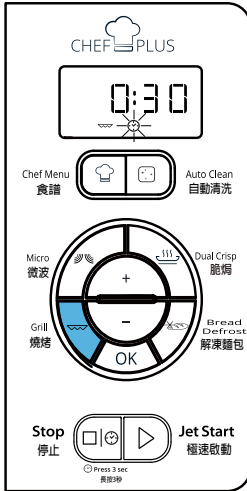

Dedicated
Accessory:



High Rack

- 1 Press the Grill button.
- 2 Press Plus/Minus buttons to set the cooking time.
- 3 Press the OK/Jet Start button. The function will start.

Tips and suggestions:

- For food like cheese, toast, steaks and sausages, place food on the high Wire Rack.
- Ensure that the utensils used are heat resistant when you use this function.
- Do not use plastic utensils when grilling. They will melt. Items of wood or paper are not suitable either.
- Be careful, not to touch the ceiling beneath the grill element.



COMBI GRILL (MICROWAVE +GRILL)

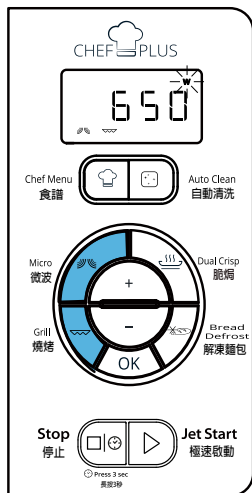

This function combines Grill and Microwave heating, allowing you to cook gratin in less time.

Dedicated
Accessory:



High Rack

- 1 Press the Grill button.
- 2 Press the Microwave button.
- 3 Press Plus/Minus buttons to set the Microwave power (see the below table).
- 4 Press the OK button to confirm.
- 5 Press Plus/Minus buttons to set the cooking time.
- 6 Press the OK/Jet Start button. The function will start.

Note: alternatively, you can first press the Microwave button and then the Grill button.

Once the cooking process has been started:

- To adjust the power: first press the Microwave button then press the Plus/ Minus button to adjust the value.
- To increase time/decrease time: press the Plus/Minus buttons, or press Jet Start button to increase the cooking time of 30 seconds.
- If Grill is pressed, we enter in MW mode (so basically Combi Grill function is exited). Then if Grill is pressed again, we enter in Combi Grill function again.

POWER LEVEL	SUGGESTED USE:
650 W	Vegetables
500 W	Poultry
350 W	Fish
160 W	Meat
90 W	Gratined Fruit

Tips and suggestions:

- Do not leave the oven door open for long periods when the Grill is in operation, as this will cause a drop in temperature.
- Ensure that the utensils used are microwave safe and heat resistant when you use this function.
- Do not use plastic utensils when grilling. They will melt. Items of wood or paper are not suitable either.
- Be careful, not to touch the ceiling beneath the grill element.
- If you cook large food such as poultry, put food on microwave and oven safe dish, directly put on the turntable.



BREAD DEFROST

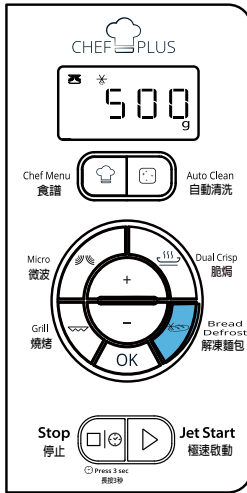



This exclusive Whirlpool function allows you to defrost frozen bread. Combining both Defrost and Crisp technologies, your bread will taste and feel as if it were freshly baked.

Use this function to quickly defrost and heat frozen rolls, baguettes & croissants.

Bread Defrost can be used if the net weight is between 50g-500g.

The following accessories must be used with this function:

- The Crisp Plate;
- The Crisp Handle to manage the hot Crisp Plate.

Dedicated accessories:  Crisp Plate  Crisp Handle

- 1 Press the Bread Defrost button.
- 2 Press Plus/Minus buttons to select the weight.
- 3 Place the empty Crisp Plate on the Glass Turntable, close the door and press the OK/Jet start button. The display will show "PRE HEAT" and the oven will use Microwaves and Grill in order to preheat the Crisp Plate. When the temperature will be reached, a message ("ADD") will inform you that you can add your bread.
- 4 Place your bread on the crisp plate, close the door and press the OK/Jet Start button. The function will start.

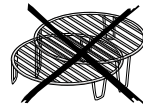

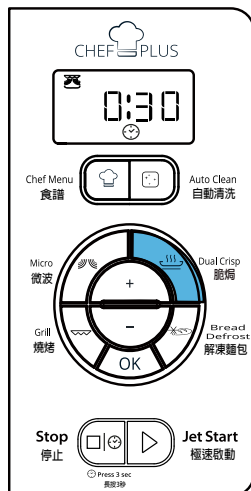

This exclusive Whirlpool function allows for perfectly golden brown results both on the top and bottom surfaces of the food. Using both Microwave and Grill cooking, the Crisp Plate will rapidly reach the right temperature and begin to brown and crisp the food.

The following accessories must be used with the Crisp function:

- The Crisp Plate;
- The Crisp Handle to manage the hot Crisp Plate.

Use this function to reheat and cook pizzas, quiches, and other dough based food. It is also good for frying bacon and eggs, sausages, potatoes, french fries, hamburgers and other meats etc. without adding oil (or by adding only a very limited quantity of oil).

Dedicated accessories:



Crisp Plate



Crisp Handle

- 1 Press the Crisp button.
- 2 Press the Plus/Minus buttons to set the cooking time.
- 3 Press the OK/Jet Start button. The function will start.

Use only the provided Crisp Plate with this function. Other available Crisp Plates on the market will not give the correct result when using this function.

Tips and suggestions:

- Ensure that the Crisp Plate is correctly placed in the middle of the Glass Turntable.
- The oven and the Crisp Plate become very hot when using this function.
- Do not place the hot Crisp Plate on any surface susceptible to heat.
- Be careful, not to touch the ceiling beneath the Grill element.
- Use oven mittens or the Crisp Handle when removing the hot Crisp Plate.
- Before cooking food that does not require a long cooking time (pizza, cakes...), we recommend to pre-heat the Crisp Plate 2-3 minutes in advance.

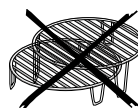



CHEF MENU

A selection of automatic recipes with pre-set cooking parameters values to offer optimal cooking results.

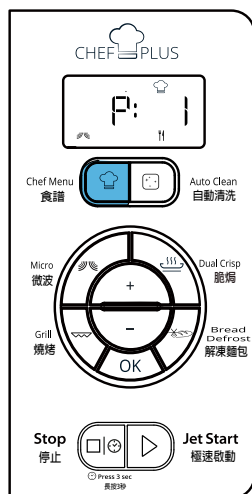

- 1 Press the Chef Menu button.
- 2 Press and hold Plus/Minus buttons to select the food type (**see the CHEF MENU table in your Quick Reference Guide**).
- 3 Press the OK button to confirm.
- 4 Depending on the food type, the display could ask you to set the Weight. Use the Plus/Minus buttons to set the asked values.
- 5 Press the OK/Jet Start button. The function will start.

The duration of the function will be automatically calculated on the basis of the selected food and weight.

i Tips and suggestions:

- For large amounts/pieces of food like roasts and oven baked fish a standing time of 8 - 10 minutes is recommended.
- For food like vegetables, hot dogs and steamed fish recommended standing time is 2 - 3 minutes.
- For details requested to add/stir/turn food, see "Add / Stir /Turn food" chapter in page 10.



Discover all the recipes available on your product!

Go to the **Chef  Menu** section of your **QUICK REFERENCE GUIDE**.



AUTO CLEAN

This automatic cleaning cycle will help you to clean the microwave oven cavity and to remove unpleasant odors.

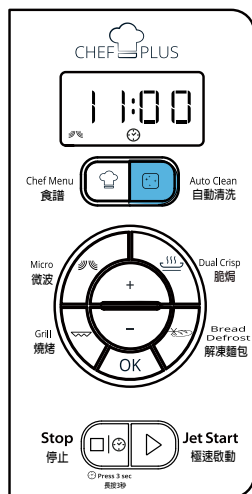

BEFORE STARTING THE CYCLE:

- 1 Put 235ml water into a container (see our recommendations in the below section "Tips and suggestions").
- 2 Place the container directly on the Glass Turntable.

TO START THE CYCLE:

- 3 Press just once the Auto Clean button, the cleaning cycle duration will be visible on the display.
- 4 Press the OK/Jet Start button to start the function.

WHEN THE CYCLE IS FINISHED, a beep will signal once every 10 seconds for 10 minutes when the cleaning cycle is finished:

- 5 Press the Stop button or open the door to cancel the signal.
- 6 Remove the container.
- 7 Use a soft cloth or a paper towel with mild detergent to clean the interior surfaces.

Tips and suggestions:

- For a better cleaning result, **it is recommended to use a container with a diameter of 17- 20cm, and a height that is lower than 6.5cm.**
- It is recommended to use a container of light plastic material that is suitable for the microwave.
- As the container will be hot after the cleaning cycle is complete, it is recommended to use a heat resistant glove when removing the container from the microwave.
- For a better cleaning effect and removal of unpleasant odors, add some lemon juice to the water.
- The Grill element does not need cleaning since the intense heat will burn off any splashes, but the ceiling beneath it may need regular cleaning. This should be done with a soft and damp cloth with mild detergent.
- If the Grill is not used regularly, it should be run for 10 minutes a month to burn off any splashes, in order to reduce the risk of fire.

ENVIRONMENTAL HINTS

The packing box may be fully recycled as confirmed by the recycling symbol. Follow local disposal regulations. Keep potentially hazardous packaging (plastic bags, polystyrene etc.) out of the reach of children.

This appliance is marked according to the European directive 2002/96/EC on Waste Electrical and Electronic Equipment (WEEE). By ensuring this product is disposed of correctly, you will help prevent potential negative consequences for the environment and human health, which could otherwise be caused by inappropriate waste handling of this product.

The symbol on the product, or on the documents accompanying the product, indicates that this appliance may not be treated as household waste. Instead it shall be handed over to the applicable collection point for the recycling of electrical and electronic equipment.

Disposal must be carried out in accordance with local environmental regulations for waste disposal.

For more detailed information about treatment, recovery and recycling of this product, please contact your local city office, your household waste disposal service or the shop where you purchased the product.

Before scrapping, cut off the mains cord so that the appliance cannot be connected to the mains.

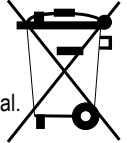

In accordance with IEC 60705, Edition 4, 2010-04.

The International Electrotechnical Commission has developed a standard for comparative testing of heating performance of different microwave ovens. We recommend the following for this oven:

TEST	AMOUNT	APPROX. TIME	POWER LEVEL	CONTAINER
12.3.1 (Egg custard)	1000 g	11-12 min.	800W	Pyrex 3.227
12.3.2 (Sponge cake)	475 g	7 min.	800W	Pyrex 3.827
12.3.3 (meat loaf)	900 g	14-15 min.	800W	Pyrex 3.838
12.3.4 (Potato gratin)	1100 g	18-20 min.	Grill+650W MW	Pyrex 3.827
13.3 (Manual defrost)	500 g	12-14 min.	160W	3mm plastic plate

TECHNICAL SPECIFICATION

Data Description	MCP 345
Supply Voltage	230V~50 Hz
Rated Input Power	1750W
Outer dimensions (HxWxD)	301 x 520 x 425
Inner dimensions (HxWxD)	222 x 336 x 331



目錄

安裝指引

- 22 安裝指引

安全注意事項

- 23 重要安全注意事項
- 24 問題解決指南
- 25 注意事項

附件和維護

- 26 配件
- 27 維護保養及清潔

控制面板

- 28 控制面板

一般使用

- 29 待機模式
- 29 啟動保護/兒童鎖定
- 29 暫停或停止烹飪
- 29 添加/攪拌/翻轉食物
- 30 時鐘

烹飪功能

- 31 極速啟動
- 32 微波
- 33 燒烤
- 34 微波燒烤組合
- 35 解凍麵包
- 36 脆焗

特別功能

- 37 食譜

可選

- 38 自動清洗

環境提示

- 39 環保建議
- 39 技術規格

安裝指引

-接駁電線之前

請將微波爐放置在遠離熱源的地方。為了確保通風良好，微波爐頂部必須留有**30厘米**的空間。此爐必須背靠牆放置，確保微波爐底部，頂部及兩邊空氣流通。本爐具不應放置櫥櫃內使用。

本爐具不用於或放置在離地板少於850毫米以上的工作面上。

請先檢查額定電壓銘牌上的電壓是否與您家中的電壓相配合。

請不要移除爐腔內壁上的微波出口防護檔板。它們可以防止油脂或食物微粒進入微波孔中。

請將微波爐放置在平坦及穩固的地方，該處必須足以承托爐具與食物器皿的重量。放置時請務必小心。

確保微波爐底部，頂部及兩邊空氣流通。

必須確定微波爐沒有損壞。可檢查爐門關上時是否緊貼門框，以及內門的封邊是否完整無缺。將爐具內配件取出，然後用柔軟的濕布清潔爐具內部。

電線、插頭如有損壞，或爐具不能正常操作，或受到損壞或翻倒，則切勿使用微波爐。切勿將電線或插頭浸入水中，並避免接觸灼熱的表面，否則會引致觸電、火災或其他意外。

請勿延長電源線：

如果你的電源線不夠長，請尋找合格的電工或維修人員在爐具附近安裝插頭。

警告：對接地插頭不正確的使用可能會導致被電擊。如果你對接地裝置的安裝不明白或者懷疑微波爐是否有正確的接地，請務必諮詢合的電工或維修人員。

-連接之後

微波爐只有在爐門緊閉之後才能操作。

如將微波爐放置在電視機、收音機或天線附近，可能會影響接收或引起干擾。

本產品必須接駁地線。

用戶如果不遵守這項規定，而導致任何人身、動物傷亡與財物損失，製造商概不負責。

重要安全注意事項

請仔細閱讀本說明書並留做日後參考

若微波爐內部/外部的材料點燃或冒煙，請務必保持爐門關閉。斷開電源線或切斷保險絲或斷路器面板上的電源。

請務必經常留意爐內狀況，尤其是在使用紙制物品、塑膠或其他易燃材料，所製造的器皿時。烹煮食物時，紙張可能會起火燃燒或燒焦，塑膠甚至可能會被熔解。

警告：本產品及其可觸及部件在使用過程中會變熱。應注意避免接觸烤箱內的加熱元件。

微波爐主要用於加熱食品和飲料。食物或衣服的干燥以及變暖墊，拖鞋，海綿，濕布等的加熱可能導致受傷，著火或著火的危險。

兒童應與爐具保持遠離，除非在成人監督下。

兒童使用本爐具前必須得到恰當的指引，才被允許不在成人的監管下使用本微波爐，確保他們能夠安全地使用本產品，並明白不適當使用微波爐帶來的後果。如果你的微波爐具備其他熱源能與微波爐同時使用，會產生比較高的溫度，兒童只有在成人的監督下才能使用微波爐。

此微波爐並非設計給身體，感官或精神上能力不足，或經驗及知識不足的人士使用（包括兒童），除非監護其安全的負責人監督或指引其使用。務必確保兒童不會把微波爐當作玩具。

應監督兒童以確保他們不玩耍電器。將本產品及其電線置於8歲以下兒童接觸不到的地方。

警告：不要使用微波爐加熱密封容器中的任何東西。上升的氣壓可能會導致容器損壞或引起爆炸。

警告：必須定期檢查門封條，門密封膠圈和門密封區域是否有損壞。如果這些區域損壞，則在由經過培訓的維修技術人員修理設備之前，不應操作設備。

不要使用您的微波爐烹飪或重新加熱帶或不帶殼的全蛋，因為即使在微波加熱結束後它們也可能爆炸。

本產品不能依靠外部計時器或獨立的遙控系統操作。

重要安全注意事項

如果你使用大量的脂肪或油，不要離開本爐具令其無人看管，因為他們可能會過熱，造成火災！

不要在本產品內或爐具加熱或使用易燃材料。煙霧可能會造成火災或爆炸。

不要使用微波爐烘乾紡織品，紙張，香料，草藥，木材，花卉或其他可燃材料。可能導致火災。

請勿在本產品中使用腐蝕性化學物品或氣體。這種類型的微波爐專門設計用於加熱或烹飪食物。它不是為工業或實驗室使用而設計的。

不要將重物放在門上，否則可能會損壞微波爐開口和鉸鏈。門把手不應用於掛物。

問題解決指南

若微波爐不能操作，請檢查下列各項後才致電維修中心：

- ❏ 轉盤和轉盤托架是否固定就位
- ❏ 插頭是否完全插入插座
- ❏ 爐門是否完全關閉
- ❏ 檢查保險絲，並確定已接上電源
- ❏ 檢查微波爐是否有良好的通風環境
- ❏ 等待十分鐘後再嘗試操作
- ❏ 再作嘗試前，請開啟爐門，然後將其關上。

以上檢查，可避免不必要的檢查維修，維修服務可能會收費。

致電維修服務中心時，請提供機身編號及微波爐型號（請參閱維修服務標籤）。有關詳細資料，請參閱保修卡。

若需更換電源線，必須使用原廠產品，並由接受過專業培訓的維修技師負責更換。有關的電源線可聯絡維修中心。

維修工作應交由專業的技師執行，若由非合格的人員進行維修並涉及拆除防止微波外泄的保護蓋，均屬非常危險。

切勿拆除任何蓋子。

注意事項

■一般注意事項

本產品僅供家居使用。

爐內沒有食物時，切勿使用本微波爐，否則可能會對爐具造成損壞。

爐頂的排氣孔必須保持暢通。若爐具抽氣或排氣受阻的話，均會對爐具造成損壞，以及影響烹調效果。

假如您要學習使用的技巧，可把一杯清水放置在爐內，讓清水將微波能量吸收，以免損壞爐具。
注意：參考下面“流質食物”內容。

切勿將微波爐放置在室外或在室外使用。

爐具不應存放在廚房水槽、泳池附近以及潮濕的地窖等地方。

切勿將爐腔作存放物品之用。

食物在放入微波爐前，應先去除紙袋或膠袋口的金屬封口線。

切勿使用微波爐來油炸食物，因為油的溫度無法控制。

烹調之後，觸碰容器、爐具零件及烤盤前，請務必使用隔熱墊或隔熱手套。烹調時爐具可接觸到的部分會變熱，小孩切勿接近。

■流質食物

用微波爐加熱的飲品或清水，即使煮得過熱，甚至超過沸點，也未必會出現沸騰的氣泡，但是液體卻可能會突然溢出造成燙傷。

為了避免發生上述情況，請遵守下列幾點：

1. 請避免使用窄頸的直身容器。
2. 將流質食物放入爐內之前，請先加以攪拌，並將湯勺留在容器內。
3. 流質食物加熱之後，請讓它留在爐內一會兒，再加以攪拌，才將容器小心拿出。

■注意

奶樽或嬰兒食物器皿中的食品或飲料加熱之後，在餵食之前，先將食物加以攪拌及測試食物的溫度，確保熱力分佈均勻，以避免燙傷或灼傷嬰兒。

請確保加熱前已將樽蓋與奶嘴取出！

有關詳細信息，請參閱微波烹飪書。特別是，如果烹飪或重新加熱含酒精的食物。確保蓋子和奶嘴在加熱之前取下！

配件

一般資料

市面上出售的配件種類繁多，請在購買之前先確定是否適合本微波爐使用。

在烹煮食物之前，請確保您使用的器皿適用於微波爐，並可讓微波通過。

將食物及配件放進微波爐時，請確保它們與配件沒有直接觸及爐壁或頂部。
在使用金屬配件或帶有金屬材質的配件時，尤需加倍小心。

在微波爐運作時，如果配件的金屬部分誤觸微波爐的內壁或頂部的話，可能會產生火花並導致微波爐損壞。

在使用微波爐之前，請確保轉盤可自由轉動。
若轉盤不能自由轉動，請使用較小的容器。

轉盤托架

請將轉盤托架放置在玻璃轉盤下。切勿在轉盤托架上放置其他器皿。

* 把轉盤托架裝入微波爐中



玻璃轉盤

各種烹調模式皆應使用玻璃轉盤。它可以避免食物碎屑及肉汁沾汙微波爐內腔。
請將玻璃轉盤置放在轉盤托架上。



燒烤架

燒烤架用於燒烤功能或與其他熱源組合功能。



脆焗盤

將食物直接放在脆焗盤上。使用脆焗盤時，應使用玻璃轉盤作為支撐。
切勿將其他器皿放在脆焗盤上，因為脆焗盤會快速變熱，並對器皿造成損毀。
在使用前，可以預熱脆焗盤（僅需3分鐘）。請使用脆焗功能預熱脆焗盤。



焗盤手柄

使用附送的專用脆焗盤手柄，取出微波爐內燙熱的脆焗盤。



盤蓋附件（附件單獨出售）

此蓋子用於在烹飪和覆蓋食物時用微波爐加熱，並有助於減少飛濺，保持食物水分以及減少所需的時間。
使用蓋子進行兩級再加熱。

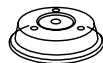

維護保養及清潔

未能將微波爐保持在乾淨的狀態可能會導致表面變質，從而對微波爐的壽命產生不利影響，並可能導致危險情況發生。

不要使用可能損壞控制面板，內部和外部表面的金屬擦洗墊，研磨性清潔劑，鋼絲刷，粗糙的抹布等。使用混合溫和洗滌劑的布或用噴霧玻璃清潔劑的紙巾。將噴霧玻璃清潔劑塗抹在紙巾上再進行清潔。

清潔微波爐時不要使用蒸汽清潔設備。
應定期清潔微波爐，清除任何食物沉積物。

請定期取出轉盤和轉盤支架，清潔爐腔底部（尤其在翻倒食物後）。使用柔軟的濕布和溫和的清潔劑清潔爐腔內壁、爐門前後、門封以及開門位置。

微波爐只要勤加清潔，便是最佳的維護方法。但在清潔前，必須關掉電源。

不要直接噴在微波爐上。

該微波爐設計用於在轉盤就位的情況下操作。

當轉盤已取下進行清潔時，不要操作微波爐。

不要讓油脂或食物顆粒堆積在門周圍。對於頑固的污漬，在微波爐中煮一杯水2或3分鐘。蒸汽會軟化污漬。

本產品提供自動清洗功能，可輕鬆清潔微波爐腔。有關詳細信息，請參閱第38頁上的自動清洗部分。

燒烤元件不需要清洗，因為強烈的熱量會燒掉任何飛濺，但燒烤元件下方的內壁可能需要定期清洗。這應使用溫和洗滌劑的軟布和濕布進行。

如果不經常使用燒烤功能，應該每月運行此功能10分鐘，以燒掉任何食物殘渣，以減少火災的危險。

小心清潔：

脆焗盤必須用溫和的清潔劑清洗。要去除頑固污漬，可用百潔海綿及溫和的去垢劑清洗。

清洗前必須讓脆焗盤冷卻。

當脆焗盤仍熱時，請勿用水將它浸泡或清洗。將脆焗盤快速冷卻可能會令其損壞。

切勿用金屬刷清潔脆焗盤，否則會刮花表面。

下列配件適用於洗碗碟機清洗：

- 轉盤支架
- 燒烤架
- 脆焗盤手柄
- 轉盤
- 盤蓋(需另外購買)

控制面板

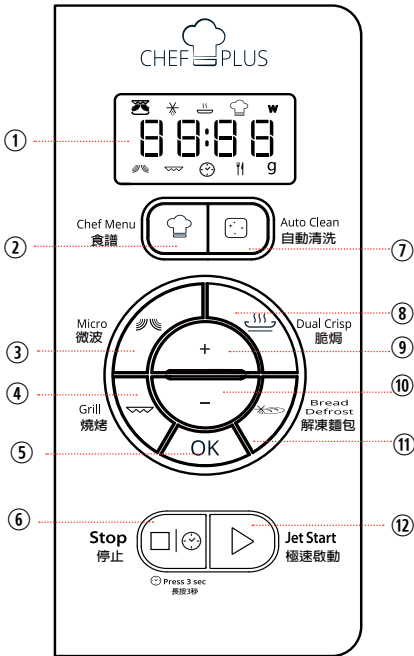

- 1 顯示屏
- 2 食譜掣
- 3 微波掣
- 4 燒烤掣
- 5 確定掣
- 6 停止/時鐘掣
- 7 自動清洗掣
- 8 脆焗掣
- 9 加掣
- 10 減掣
- 11 解凍麵包掣
- 12 極速啟動掣

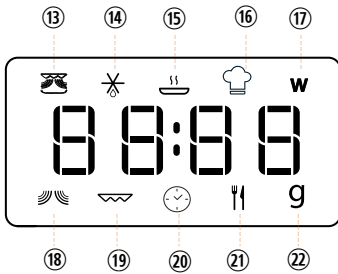

- 13 脆焗標誌
- 14 極速解凍標誌
- 15 極速加熱標誌
- 16 食譜標誌
- 17 微波火力 (watt)
- 18 微波標誌
- 19 燒烤標誌
- 20 時鐘設定 / 時間選擇
- 21 食物類型選擇
- 22 重量 (grams)

待機模式

當顯示時鐘時，微波爐處於待機模式（或者，如果時鐘未設置，顯示屏將顯示“:”）。

啟動保護/兒童鎖定

此自動安全鎖功能會在微波爐回復“備用”模式後的1分鐘後啟動。安全鎖必須在爐門開啟及關閉之後（例如將食物放入爐中）才會解開。如果您沒有放入食物便開始操作微波爐的話，顯示屏便會顯示DOOR（爐門）的字樣：

door

暫停或停止烹飪

要暫停烹飪：

可以暫停烹飪以檢查烹調情況，通過打開爐門來轉動或攪拌食物。設置將保持5分鐘。

繼續烹飪：

關閉爐門，然後按極速啟動掣一次。烹飪從暫停的地方恢復。

如果你不想繼續烹飪，你可以：

取出食物，關上爐門，然後按停止掣。

烹飪完成後：

顯示屏將顯示“End”。嗶聲響將每分鐘發出一一次信號，持續10分鐘，這是用於冷卻產品的正常行為。

根據產品的不同，冷卻風扇或內部燈泡可能會繼續工作。

如果需要，只需按下停止按鈕或打開爐門以取消信號並停止冷卻時間。請注意，減少或停止此編程冷卻循環不會對產品的功能產生負面影響。

注意：如果爐門打開，微波爐將只保留60秒的設置，然後在完成烹飪後關閉。

添加 / 攪拌 / 翻轉食物

根據所選功能，可能需要在烹飪期間添加/攪拌/翻轉食物。在這些情況下，微波爐將暫停烹飪，它會要求您執行所需的操作。

需要時，您應該：

- 1 打開爐門。
- 2 添加/攪拌/翻轉食物（取決於所需的動作）。
- 3 關閉爐門，然後按極速啟動掣重新啟動。

注意：如果在要求添加、攪拌或轉動食物之後2分鐘內爐門沒有打開，微波爐將繼續烹飪過程（在這種情況下，最終結果可能不是最佳結果）。



時鐘

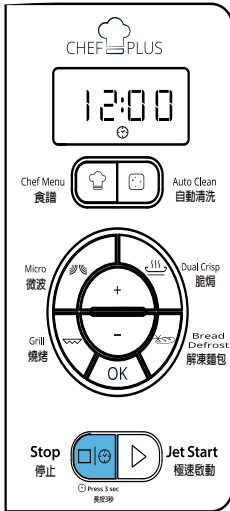

要設置微波爐的時鐘：

- 1 按住停止掣3秒鐘。
- 2 按加 / 減掣設置小時數位。
- 3 按OK / 極速啟動掣,分鐘數位將開始閃爍。
- 4 按加 / 減掣設置分鐘。
- 5 按OK / 極速啟動掣,時鐘設定。

注意：

第一次插上電源 (或電源故障後), 產品將自動進入時鐘設置模式;在這種情況下, 請從第2步開始執行上述步驟。



提示和建議：

- 如果插上電源後沒有設置時鐘, 時鐘將顯示“12:00”。
- 在時鐘設置期間, 如果按下停止掣或如果長時間後未完成時間設置, 微波爐將退出設置模式, 設置將無效, 顯示屏將顯示“:”。



極速啟動

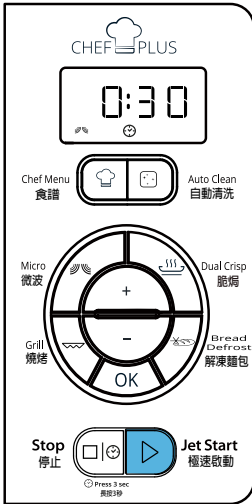

此功能允許以最大功率運行微波功能30秒。建議用於快速加熱高含水量的食物，如清湯，咖啡或茶。

1 按極速啟動掣。

按下極速啟動掣，微波功能將在最大火力（800W）下運行30秒。

每次額外的按下極速啟動掣將增加30秒的烹飪時間。

如果您已經選擇了烹飪功能（例如：燒烤），請按極速啟動掣啟動所選功能。

i 提示和建議：

•即使在烹飪過程已經開始後，也可以更改火力和持續時間。要調整火力，只需反覆按下微波掣。要更改烹飪時間，請按加/減掣，或按極速啟動掣可將烹飪時間增加30秒。



微波

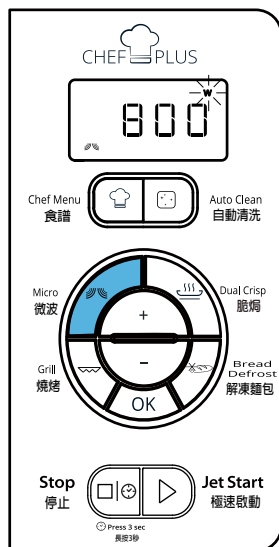

此功能適用於快速烹煮或加熱食物和飲料。

專用配件:  盤蓋 (需另外購買)

- 1 按下微波掣。顯示屏上將顯示最大火力 (800 W) , 瓦特圖標開始閃爍。
- 2 按加 / 減掣設置火力。
- 3 按OK掣確認。
- 4 按加 / 減掣設置烹飪時間。
- 5 按OK / 極速啟動掣。該功能將被啟動。

在烹調過程開始之後:

- 調整火力: 首先按下微波掣, 然後按加/減掣調整火力。
- 增加時間/減少時間: 按加/減掣, 或按極速啟動掣可將烹飪時間增加30秒。

火力	建議用於
800 W	重新加熱飲料, 水, 清湯, 咖啡, 茶或其他高含水量食物。如果食物含有雞蛋或忌廉, 選擇較低的功率。
650 W	烹飪魚類, 肉類, 蔬菜等。
500 W	烹調需要較小心處理的食物, 例如含豐富蛋白質的醬汁、芝士及雞蛋菜式, 以及可以烹調煲仔菜。
350 W	蒸燉食物, 融化牛油。
160 W	解凍。
90 W	軟化雪糕、牛油及芝士。保持溫暖。



燒烤

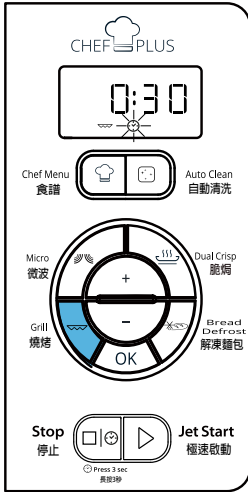

此功能採用了功能強大的石英燒烤管，能讓食物表面變金黃，達到燒烤效果。
該功能適用於烤乳酪烤麵包，熱三明治，土豆丸子，香腸，蔬菜。

專用配件： 高燒烤架

- 1 按燒烤掣。
- 2 按加 / 減掣設置烹飪時間。
- 3 按OK / 極速啟動掣。該功能將被啟動。

提示和建議：

- 烹調芝士、多士、肉扒及香腸等食物時，將食物放置在高燒烤架上。
- 使用該功能時，請先確定所使用的器皿是否耐熱，且可在微波爐中使用。
- 請勿使用塑膠器皿來燒烤食物，以免塑膠器皿熔化。木質或紙質的器皿也不適用。
- 切勿觸摸燒烤元件下的爐頂部。





微波燒烤組合

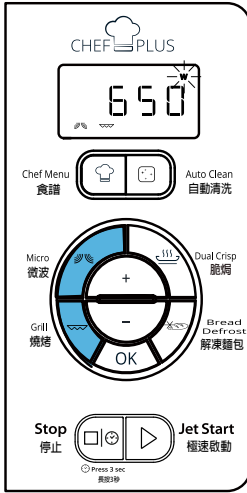

此功能結合了燒烤和微波加熱，使您可以在更少的時間內燒烤食物。

專用配件： 高燒烤架

- 1 按燒烤掣。
- 2 按下微波掣。
- 3 按加 / 減掣設置微波火力（見下表）。
- 4 按OK掣確認。
- 5 按加 / 減掣設置烹飪時間。
- 6 按OK / 極速啟動掣。該功能將被啟動。

注意：或者，您可以先按下微波掣，然後按下燒烤掣。

在烹調過程中：

- 調節微波火力：按微波掣並按加 / 減掣調節微波火力。
- 增加 / 減少時間：按加 / 減掣或按極速啟動掣將烹調時間增加30秒。
- 如果按下燒烤，將會進入微波模式（退出微波燒烤功能）。如果再次按下燒烤掣，將再次進入微波燒烤功能。

火力等級	建議用於	
650 W		蔬菜
500 W		家禽類
350 W		魚類
160 W		肉類
90 W		脆焗雜果

提示和建議：

- 在燒烤時，請勿將爐門長時間打開，會導致爐內溫度下降。
- 使用此功能前，請務必保證所使用的器皿是耐熱且可在微波爐中使用。
- 請勿使用塑膠器皿來燒烤食物，以免塑膠器皿熔化。木質和紙質器皿都不適用此功能。
- 切勿觸摸燒烤元件下的爐頂部。
- 如果你做體積較大的食物，如家禽，可將食物放在適用於微波爐或焗爐的碟上，然後直接放在轉盤上烹調。



解凍麵包

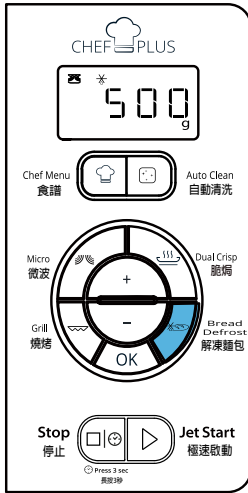

惠而浦獨有的這項功能適用於解凍冷凍麵包。使用解凍和脆焗技術，使麵包像新鮮出爐一樣美味。使用此功能可快速解凍和加熱冷凍卷，法式麵包和牛角包。解凍麵包適用於解凍淨重50-500G的食物。

此功能必須使用以下附件：

- 脆焗盤
- 脆焗盤手柄，以取出滾燙的脆焗盤。

專用配件：



脆焗盤



脆焗盤手柄

- 1 按解凍麵包掣。
- 2 按加 / 減掣選擇重量。
- 3 將空的脆焗盤放在玻璃轉盤上，關閉爐門，然後按OK / 極速啟動掣。顯示屏將顯示“PRE HEAT”，微波爐將使用微波和燒烤功能，以預熱脆焗盤。當達到設定溫度時，顯示屏將顯示（“ADD”），提示您可以添加您的麵包。
- 4 將麵包放在脆焗盤上，關上爐門，然後按OK / 極速啟動掣。該功能將被啟動。

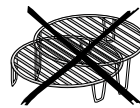



脆焗

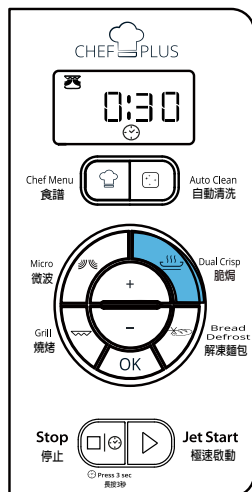

惠而浦獨有的脆焗功能使食物的底部和表面呈現完美的金黃色。使用微波和燒烤烹煮，能夠使脆焗盤迅速地達到很高的溫度並開始脆焗食物。

下面附件必須使用脆焗功能

- 脆焗盤
- 脆焗盤手柄取出微波爐內滾燙的脆焗盤

此功能適用於翻熱或脆焗薄餅及其它麵粉制食品。更可以在不添加食用油或添加少量的食用油的情況下，香煎煙肉、蛋類、香腸、薯仔、炸薯條、漢堡包及其他肉類。

專用配件：



脆焗盤



脆焗盤手柄

- 1 按脆焗掣。
- 2 按加 / 減按鈕設置烹飪時間。
- 3 按OK / 極速啟動掣。該功能將被啟動。

使用脆焗功能時，請使用隨爐附送的專用脆焗盤。市面上的其他脆焗盤不能取得同樣的烹調效果。

提示和建議：

- 確保脆焗盤正確放置在玻璃轉盤的中間。
- 使用此功能時，微波爐和脆焗盤都會很高溫。
- 請勿把脆焗盤放在任何不耐熱的物品上。
- 切勿觸摸燒烤元件下的爐頂部。
- 請使用隔熱手套或脆焗盤手柄取出滾燙的脆焗盤。
- 烹飪一些不需要長時間烹煮的食物之前，如薄餅，蛋糕，建議用戶先預熱2-3分鐘的脆焗盤。

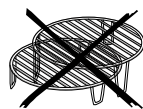



食譜

選擇具有預設烹飪參數的自動食譜，以提供最佳烹飪結果。

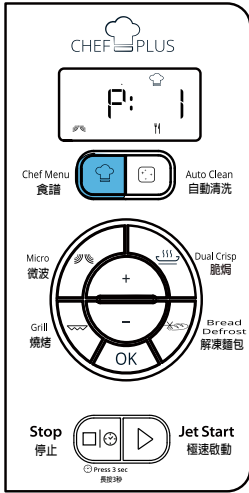

- 1 按食譜掣。
- 2 按住加/減掣選擇食物類型（請參見快速參考指引中的食譜菜單表）。
- 3 按OK掣確認。
- 4 根據食品類型，顯示屏可能會要求您設置重量。使用加/減掣設置要求的值。
- 5 按OK / 極速啟動掣。該功能將被啟動。

該功能的持續時間將基於所選擇的食物和重量自動計算。

i 提示和建議：

- 對於大量/多種食物，如烤肉和烤魚，建議放置8 - 10分鐘。
- 對於食物如蔬菜，熱狗和蒸魚建議放置2 - 3分鐘。
- 有關添加/攪拌/翻轉食物的詳細信息，請參閱第10頁的“添加/攪拌/翻轉食物”一章。



發現更多的食譜
可用於您的產品！

參考“快速參考指引”的“食譜”部分。



自動清洗

此自動清潔功能將幫助您清潔微波爐腔，並消除不潔的氣味。

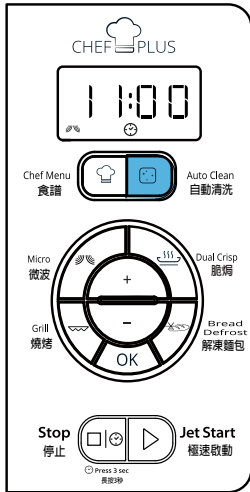

開始自動清洗之前：

- 1 將235ML水倒入容器中（請參閱下文“提示和建議”一節中的建議）。
- 2 將容器直接放在玻璃轉盤上。

開始自動清洗：

- 3 按一次自動清洗掣，清洗循環持續時間將顯示在顯示屏上。
- 4 按OK / 極速啟動掣啟動該功能。

當清洗循環完成時，每10秒鐘發出一次嘟聲，持續10分鐘：

- 5 按下停止按鈕或打開門以取消信號。
- 6 取出容器。
- 7 使用軟布或帶有溫和洗滌劑的紙巾清潔爐腔。



提示和建議：

- 為了達到更好的清洗效果，建議使用直徑17-20厘米，高度小於6.5厘米的容器。
- 建議使用適合微波爐的輕質塑料材料容器。
- 由於自動清洗結束後容器會變熱，建議從微波爐中取出容器時使用耐熱手套。
- 若想達到更好的清洗效果和去除不潔的氣味，可在水中加入一些檸檬汁。
- 燒烤元件不需要清洗，因為強烈的熱量會燒掉任何食物殘渣，但是燒烤元件下方的內壁可能需要定期清洗。這應使用混合溫和洗滌劑的濕軟布進行。
- 如果不經常使用燒烤功能，應每月運行此功能10分鐘以燒掉任何食物殘渣，以減少火災的危險。

環保建議

用來盛載本爐具的紙盒印有環保標誌，可以完全循環再造。棄置有關包裝材料時，請遵循本地的廢物棄置條例。請把可能引致危險的包裝材料(如膠袋、發泡膠等)放置在小孩接觸不到的地方。

本產品依照歐洲關於廢棄電子電氣產品條例2002/96/EC進行標識(WEEE)。用戶正確棄置能夠幫助預防對環境及人類健康潛在的負面影響。

產品上或產品檔上的此標誌表示本產品有可能不屬於家庭棄置廢物。需要將其交至指定的電子電氣產品廢置站。

本產品如日後需要棄置，請遵循本地的廢物棄置條例。

有關產品處理，恢復及迴圈使用的詳細資料，請諮詢本地政府機構，家庭棄置廢物機構或購買產品的商鋪。

棄置前請切斷電源線，使本產品不能連接電源。

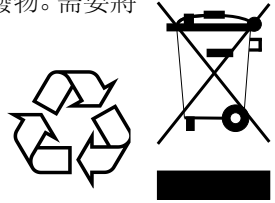

符合 IEC 60705, 版本4, 2010-04.

國際電工委員會已經開發了用於不同微波爐的加熱性能的比較測試的標準。我們建議以下用於此微波爐：

測試內容	重量	大約時間	功率等級	容器
12.3.1 (蛋羹)	1000 克	11-12 分鐘	800 瓦	Pyrex 3.227
12.3.2 (海綿蛋糕)	475 克	7 分鐘	800 瓦	Pyrex 3.827
12.3.3 (肉餅)	900 克	14-15 分鐘	800 瓦	Pyrex 3.838
12.3.4 (烤土豆)	1100 克	18-20 分鐘	燒烤+650 瓦 微波	Pyrex 3.827
13.3 (手動解凍)	500 克	12-14 分鐘	160 瓦	3mm plastic plate

技術規格

數據描述	MCP 345
電源電壓	230V~50 Hz
額定輸入功率	1750W
機身尺寸 (高x寬x深)	301 x 520 x 425
爐腔尺寸 (高x寬x深)	222 x 336 x 331

Whirlpool® Registered trademark/TM Trademark of Whirlpool group of companies

All rights reserved - <http://www.whirlpool.com.hk>

註冊商標/惠而浦集團的TM商標

版權所有 翻印必究 - <http://www.whirlpool.com.hk>



Whirlpool



W 1 1 0 9 4 6 4 7