

Whirlpool

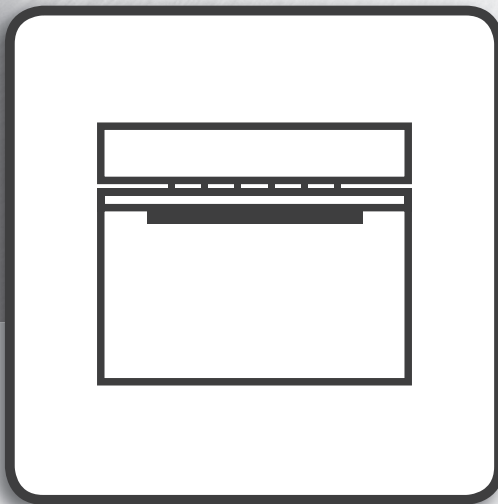

Health & Safety, Use & Care, Installation Guide and Online Warranty Registration Information

產品安全指引、使用說明、安裝指南及
網上登記保養資料

Model 產品型號: W3MS450



www.whirlpool.com.hk
www.whirlpool.com.sg

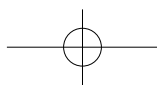

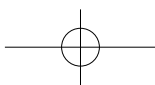
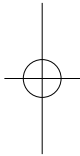
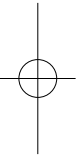
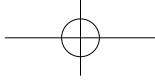

目錄

■ 使用前的準備與須知

頁

| | |
|-----------------|------|
| 重要安全資訊 | 2 |
| 首次使用前須知 | 2 |
| 使用注意及建議事項 | 2-3 |
| 安全注意事項 | 3 |
| 安裝說明 | 3 |
| 產品及配件結構圖 | 4-5 |
| 控制面板 | 6 |
| 控制面板 – 基本功能說明 | 7 |
| 控制面板 – 特別功能說明 | 8 |
| 控制面板 – 主要功能介紹 | 8 |
| 控制面板 – 主要功能詳細說明 | 9-10 |
| 使用及烹調小貼士 | 11 |

■ 操作方法說明

頁

| | |
|---------------------|-------|
| 設置時鐘 | 12 |
| 蒸氣模式 | 13 |
| 熱風加蒸氣模式 | 14 |
| 全功能蒸焗模式 | 15 |
| 頂部 / 底部 / 上下燒烤模式 | 16-17 |
| 熱風模式 | 18 |
| 加強熱風對流模式 | 19 |
| 熱風對流模式 | 20 |
| 解凍模式 | 21 |
| 乾果模式 | 22 |
| 預熱模式 (蒸氣) | 23 |
| 預熱模式 (烤焗) | 24 |
| 發酵模式 | 25 |
| 保溫模式 | 26 |
| 除垢模式 | 27-28 |
| 消毒模式 | 29 |
| 烘乾爐腔模式 | 30 |
| DIY 煮食模式 | 31-32 |
| 預約功能 | 33-34 |
| 烹調過程中調校 / 結束後追加時間功能 | 35-36 |
| 餘溫高溫提示 | 37 |
| 童鎖功能 | 37 |

■ 清潔及保養

頁

| | |
|-----------|----|
| 清潔及保養 | 38 |
| 層架拆卸與安裝 | 39 |
| 內隔熱罩拆卸與安裝 | 40 |
| 水箱的拆卸與安裝 | 40 |

■ 其他須知

頁

| | |
|------|-------|
| 故障排解 | 41-42 |
| 產品規格 | 43 |

使用前的準備與須知

■ 重要安全資訊

本說明包含有關產品安全、使用、維護及保養的重要資訊，請仔細閱讀本說明書，並將本說明書存放於容易提取的地方，以備將來查閱。

■ 首次使用前須知

1. 此產品很重，需要兩個人或以上安裝或移動此產品，必須將產品放置在堅固及平穩的表面，否則會造成身體傷害或產品損壞。
2. 此產品只設計作室內和家庭用途。請依照說明書內列明的煮食方法使用。切勿使用此產品作戶外、商業或其它用途。
3. 請確保家中使用的電壓與產品標籤上的電壓一致。
4. 產品送抵後請確保產品沒有損壞。如產品出現下列情況，請勿操作本產品：例如電源線或插頭受損、產品無法正常操作、產品受損或曾墜落。如果出現任何損壞，請聯絡惠而浦客戶服務部。
5. 切勿把電源線或插頭浸入水中，並避免電源線接觸高溫的表面，以免發生觸電，火災或其他意外。
6. 請勿阻擋或堵塞蒸焗爐的散熱通風口，以免對蒸焗爐造成損壞。
7. 在使用蒸焗爐前，以「消毒模式」進行30分鐘的消毒清潔。
8. 生產商不承擔一切由於客戶不正確使用本產品而產生的問題。
9. 前排氣出風口會有低溫蒸氣排出，切勿遮蓋前排氣出風口，以免損壞蒸焗爐。
10. 應使用耐高溫容器進行烹調，如耐熱性玻璃、耐熱性塑料容器等。所有非耐熱性容器都不應放進蒸焗爐使用。蒸焗容器耐熱溫度應高於120°C，而烤焗容器耐熱溫度應高於250°C。
11. 第一次使用各種燒烤或烤焗的功能時，可能會產生氣味，這是正常現象。

■ 使用注意及建議事項

1. 如發現爐門或爐門密封邊損壞時，請停止使用產品並儘快聯絡惠而浦客戶服務部。
2. 如電源線何損壞，必須由供應商 / 製造商或合格技術人員更換，以免造成危險。
3. 請勿於此爐附近加熱或使用易燃物品，以免產生火警或爆炸。
4. 切勿使用本產品烘乾布料、紙張、香料、藥材、木材、花朵或其他易燃的物件，否則可能會造成火災。
5. 切勿過度烹調食物，否則可能引致火災。

6. 使用蒸焗爐時切勿離開，尤其正當在使用紙、塑膠或其他易燃材料的物件進行烹調。當用作為食物加熱時，紙張可能會著火或燒焦，某些塑料則可能溶化。如發現有物件在蒸焗爐內或外被點燃或冒煙，請將爐門關上並關掉蒸焗爐。同時拔掉電源線並將裝設有漏電斷路器的插座電源切斷。
7. 切勿在爐內使用腐蝕性化學品或氣體。此蒸焗爐專為加熱食物或烹煮食物而設計，並不適合工業或實驗用途。
8. 此產品並非設計給身體、感官或精神上能力不足，或經驗及知識不足的人士使用（包括兒童），除非監護其安全的負責人監督或指引其使用。
9. 每次完成烹調並待蒸焗爐冷卻後，請抹走可能凝固於爐腔內的殘留物。爐腔頂部最容易出現燒焦情況，應將爐腔頂部擦洗乾淨。為確保食物得到最佳烹調效果，於每次使用後，請保持爐腔完全乾透。
10. 從蒸焗爐內提取食物及器皿時，應使用隔熱手套，以免燙傷。
11. 當蒸焗爐運作時，請避免接觸爐腔內的發熱管，以免造成危險。
12. 切勿將爐腔作存放物件之用。
13. 奶樽或嬰兒食物器皿中的食物或飲料加熱後，請務必在餵食前將食物或飲料加以攪拌，並檢查食物的溫度，確保熱力分佈均勻，以避免燙傷或灼傷嬰兒。
14. 當完成蒸或烤焗煮食模式後，應等待10-15分鐘才進行其他烹調模式。
15. 剛完成烤焗煮食後或爐腔處於高溫狀態下，使用蒸氣相關模式，爐腔內的蒸氣可能會迅速蒸發，蒸氣不易被看到。這是正常現象。
16. 當使用蒸焗爐時，切勿用手觸摸爐門、爐窗及外框。
17. 請使用直接從水喉取的自來水、食用水或蒸餾水注入儲水箱，直至水位達到標註最高水位（1200ml）的位置。把儲水箱完整推進於凹位內，直至聽到「卡」一聲，確保固定到位。
18. 水箱出現裂紋或缺口時，請勿繼續使用，以免引起因漏水而導致的漏電或觸電。
19. 為確保衛生，並防止冷凝水在蒸爐內積聚，請於每次使用後清空水箱及確保爐腔完全乾透。
20. 除清水外，切勿使用儲水箱盛載其他液體（除垢劑除外）。
21. 以蒸氣模式烹調過程中儘量不要打開爐門，以免蒸氣流失和爐腔溫度下降，影響烹調效果。如有需要打開爐門，請酌量增加蒸焗時間。
22. 烹調過程中如需翻轉食物或因其它需要必須打開爐門時，請盡量不要靠近爐門（特別是臉部），以免燙傷。

使用前的準備與須知

23. 維修操作必須由專業人員進行。除專業人員外，任何維修操作均可能帶來危險。請勿擅自對產品進行拆卸、修理或改造。
24. 產品操作時，可接觸部份的溫度可能較高，切勿讓兒童靠近。
25. 通電後，切勿以濕手或其他身體部份接觸本產品、產品之電源線或插頭，亦請勿在赤腳時使用蒸焗爐，以免發生危險。
26. 切勿放置或懸掛任何物件於爐門或門上的把手，以免影響門的開關及損壞門鉸。
27. 烹調結束後，電動風扇會繼續工作一段時間，以冷卻爐腔和電子零件，屬於正常現象。
28. 如未能妥善清潔產品及其配件，會導致器具表面劣化，這會影響器具的壽命，可能會導致危險的情況。
29. 清潔前請切斷電源，不可使用具有腐蝕性的清潔劑，以免損壞或腐蝕本產品。
30. 在除垢模式時，水箱的水會被加熱，並流到接水盤內，請勿讓兒童接觸或走近。
31. 在清潔爐腔時，請切斷電源，如需要清潔風扇，請小心除去爐腔內隔熱罩，以及按照指示裝回，方可再次使用。（詳情參照說明書內“如何拆下爐腔內隔熱罩”）
32. 請不要讓蒸焗爐處於無人監看的狀態下工作。
33. 過熱的脂肪和油很容易著火。除了烤肉，在烹調過程中對油進行加熱也是很危險的，應禁止這樣操作。
34. 當玻璃門完全打開後，禁止在玻璃門上放置任何物品。
35. 當蒸焗爐門處於打開或向下位置時要小心，以免撞到門。
36. 請勿使用延長線、多個插座或適配器。安裝後用戶不得觸及蒸焗爐零件。
37. 注意：蒸焗爐的設計不是供通過外部開關設備（例如定時器）或獨立的遠程控制系統進行操作。
38. 請勿將蒸焗爐安裝在裝飾門後面 – 會有火災危險。
39. 衣物或布料或易燃物料必須遠離此蒸焗爐，直到所有配件冷卻，以免造成火災。如烹調食物富含脂肪，油脂或含酒精液體，請警惕，以免造成火災。

安全注意事項

- 經常檢查蒸焗爐、電源線、插頭是否有破損，一旦蒸焗爐、電源線或插頭有破損跡象，應停止使用，並請聯絡惠而浦客戶服務部。
- 請勿將蒸焗爐的電源線、插頭或其他任何部分浸在水中或液體中，以免產生火災或危險。
- 請勿將蒸焗爐擺放在煤氣爐、微波爐旁等高溫環境中使用，並遠離火源。

- 如果蒸焗爐在工作中接觸易燃物或被一些易燃物所覆蓋如窗簾，織物等類似東西容易引起火災。
- 警告：如果需要更換爐燈，為避免可能出現的電擊，換燈前應確認器具已斷開電源。
- 在烹飪完畢後，客戶需要等待2 – 3分鐘才能開門。
- 請不要把本產品放置在雨淋或潮濕嚴重的地方。

安裝說明

安裝說明圖示為示意圖，僅供參考。如有變更，請以實物為準。恕不另行通知。

本安裝說明中所有標註的尺寸單位為 mm。

插頭或多極開關必須安裝在可接觸的位置及按照接線規則，設備必須符合國家電氣安全標準接地。

安裝

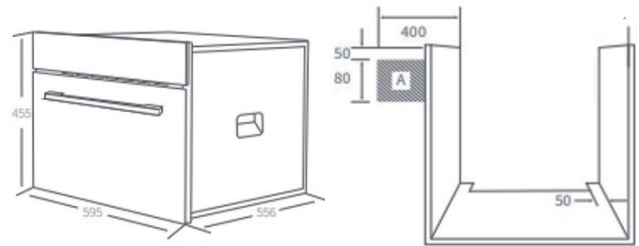

本產品的主插座建議安裝在產品的側櫃中，位於陰影區域A範圍內。

廚櫃

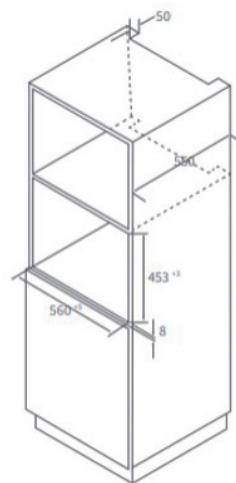

為保持通風，請保持後部有大於 50mm 的空隙距離。

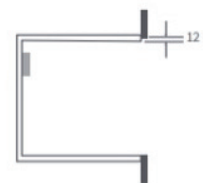

櫥櫃的面板與內孔的頂部要有 12mm 的落差高度。

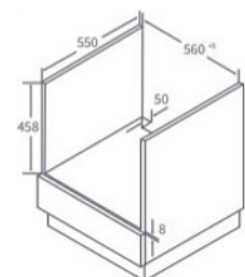

本產品底部與下櫥櫃頂部之間至少需要留有 8mm 的空間距離。

使用前的準備與須知

■ 產品及配件結構圖

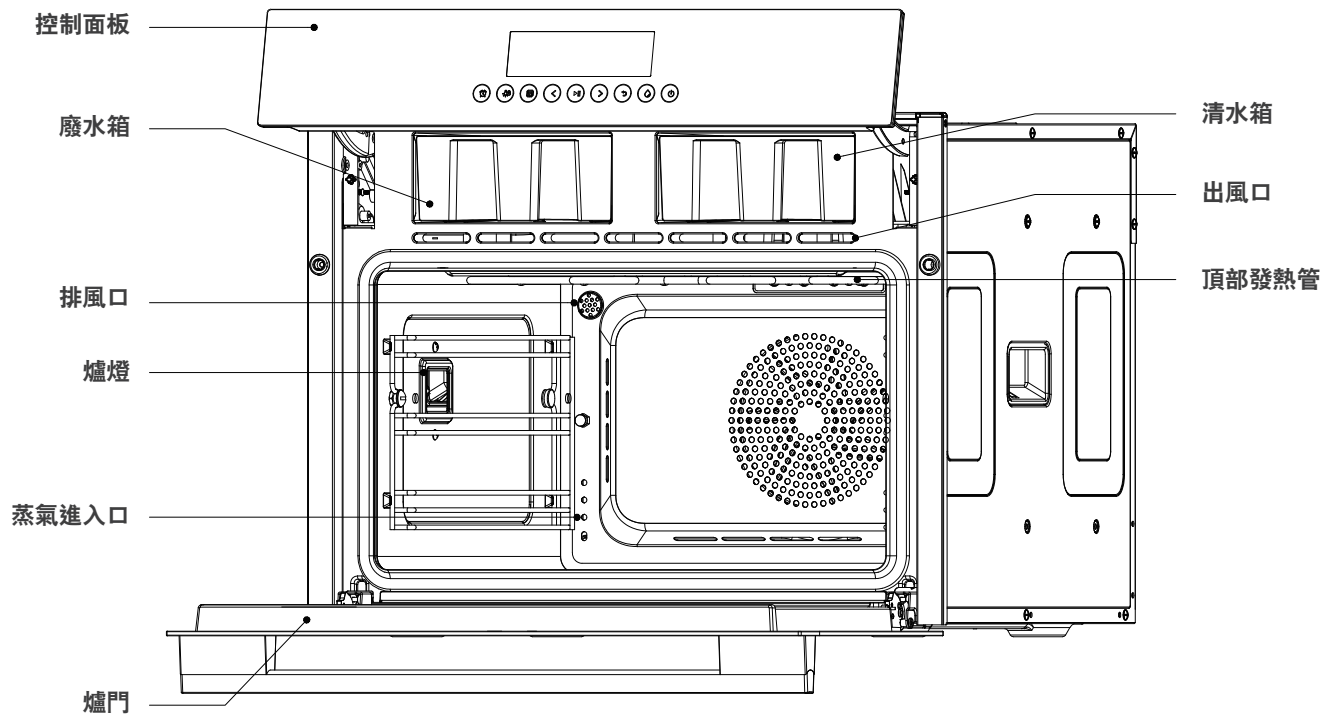

1. **控制面板**：用於操作蒸焗爐（詳細請參考控制面板說明）
2. **廢水箱**：用於收集蒸煮及除垢後蒸發盤及管道內的廢水
3. **清水箱**：用於盛載清水以產生蒸氣
4. **出風口**：排出爐內多餘的熱氣及水蒸氣。
5. **頂部發熱管**：產生熱能烹調的食物。
6. **排風口**：爐腔內多餘的蒸氣及熱氣由此孔抽到出風口。
7. **爐燈**：爐腔照明，以便觀察烹調的食物。
8. **蒸氣進口**：讓蒸氣進入爐腔內。
9. **爐門**：1. 確保爐門關上後，才開啟烹調程式。
2. 在烹調過程中，將爐門打開，烹調會暫停；把爐門關上後，會自動繼續原先的烹調設定。

使用前的準備與須知

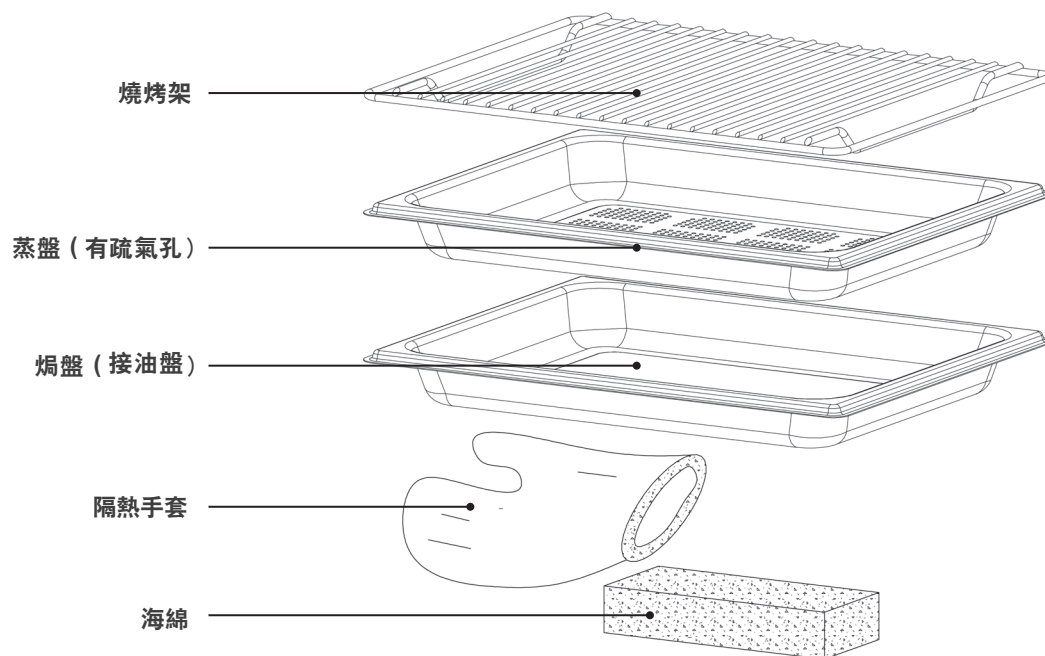

1. 燒烤架

- (A) 主要用於所有使用發熱管加熱的模式，如各個「燒烤」或「熱風對流」或「熱風」等模式使用。
- (B) 如需進行多層煮食，建議將此燒烤架放於較底層的位置，如進行三層煮食，請放於最底位置。可使爐腔內空氣更流通、讓爐腔溫度更平均。
- (C) 食物無容器盛放時，請用牛油紙或錫紙，平鋪在燒烤架上使用。

2. 蒸盤 (有疏氣孔)

- (A) 主要用於「蒸氣」時使用。其疏氣孔設計亦可用於其他烹調模式。
- (B) 如需進行多層煮食，建議將此蒸盤放於較底層的位置，如進行三層煮食，請放中間位置。可使爐腔內空氣更流通、讓爐腔溫度更平均。

3. 焗盤 (接油盤)

- (A) 主要用於「熱風加蒸氣」、「全功能蒸焗」或「熱風」等模式時使用。或於烹調肉類時放於底層，盛載煮食中滴下來的油。
- (B) 食物無容器盛放時，請用牛油紙或錫紙，平鋪在焗盤上使用。

4. 隔熱手套

由蒸焗爐拿出食物或托盤時使用。

5. 海綿

用於吸取爐腔內的倒汗水。

使用前的準備與須知

■ 控制面板

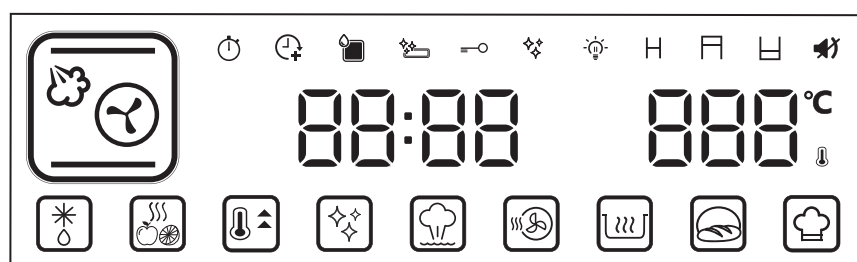

時間鍵
預約/時鐘設定



爐燈鍵



童鎖鍵



選擇鍵



確定鍵
確定 / 開始 / 暫停設定



選擇鍵



返回鍵



面板升降鍵



電源鍵

使用前的準備與須知

■ 控制面板 - 基本功能說明

| 圖示 | 功能說明 |
|---|--|
|  | 選擇鍵 功能 / 時間 / 溫度設定 |
|  | 確定鍵 確定 / 開始 / 暫停設定 |
|  | 返回鍵 1. 返回/取消； 2. 在設置過程中，按返回鍵可回到上一個畫面，即可重新調整烹調模式或烹調時間。 3. 靜音模式 啟動靜音模式：在待機狀態下長按返回鍵3秒即啟動靜音模式，顯示屏上靜音圖示亮起，按鍵音效提示關閉。 解除靜音模式：在待機狀態下長按返回鍵3秒即可解除靜音模式。 |
|  | 時間鍵 1. 時鐘設定：在待機狀態下長按時間鍵3秒鐘，即可進入設置時鐘畫面，進行時鐘設定。（詳細請參閱第13頁“設置時鐘”）； 2. 預約功能設定：烹調模式、烹調時間和烹調溫度設定後，按時間鍵，即可進入預約功能畫面，進行預約設定。（詳細請參閱第32-33頁“預約功能”）； |
|  | 爐燈鍵 1. 輕按一次，爐燈亮3分鐘，顯示屏上不會顯示爐燈圖標； 2. 長按3秒，爐燈長亮，顯示屏上會顯示爐燈圖標，再長按3秒取消長亮； 3. 打開爐門，爐燈亮3分鐘。 |
|  | 童鎖鍵 長按3秒可啟動/解除童鎖。 啟動童鎖：長按童鎖鍵3秒啟動，控制面板會被鎖定並不能操作。 解除童鎖：長按童鎖鍵3秒即可解除童鎖功能。 |
|  | 電源鍵 如果開啟蒸焗爐後，沒有進行任何操作，包括打開或關閉爐門，5分鐘後，蒸焗爐將自動進入省電模式，顯示屏會熄滅。省電模式下只有電源鍵能操作。 |

使用前的準備與須知

■ 控制面板 - 特別功能說明

| 組合鍵功能 | 圖示 | 功能說明 |
|----------------|----|---|
| 組合鍵： 爐腔溫度顯示 | | 在烹調過程中，同時按【童鎖鍵 + 爐燈鍵】3 秒，溫度顯示切換為爐腔實際溫度。 |

■ 控制面板 - 主要功能介紹

時鐘和時間

時鐘：在待機狀態下顯示為：
24 小時制。

顯示範圍：00：00 – 23：59

時間：即設定烹調時間。

可調範圍由00：05 – 12：59

水箱圖標





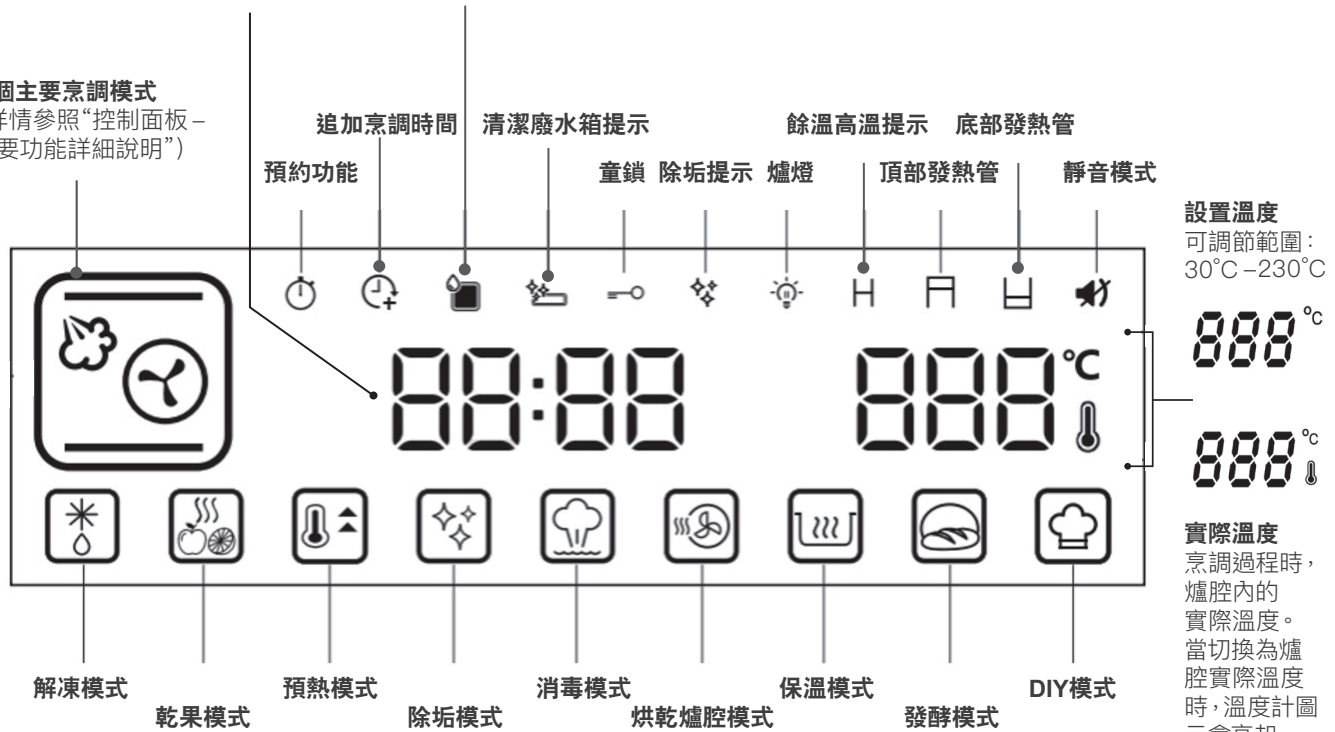



圖標閃爍亮起為清水箱
缺水提示

9 個主要烹調模式
(詳情參照“控制面板 –
主要功能詳細說明”)



使用前的準備與須知

■ 控制面板 - 主要功能詳細說明

| 圖示 | 模式 | 功能介紹 | 默認時間 / 溫度 | 時間 / 溫度選擇範圍 |
|---|--------|---|---------------|---|
|  | 蒸氣 | 此模式以蒸氣烹調食物，可保留食物原有的味道，營養及顏色。適合蒸煮蔬菜，肉類，海鮮或燉湯等。 | 20 分鐘 / 100°C | 時間 5-419 分鐘 (最長 6 小時 59 分鐘) 溫度 50 - 110°C |
|  | 熱風加蒸氣 | 以熱風煮食並加入蒸氣，讓烹調的食物不會因烤焗的高溫而流失水份。背部風扇使熱風均勻循環流動，可確保多層烤焗的食物受熱更平均。適用於煮各種食物。 | 30 分鐘 / 120°C | 時間 5-239 分鐘 (最長 3 小時 59 分鐘) 溫度 80 - 200°C |
|  | 全功能蒸焗 | 此模式集合上下火、熱風、蒸氣功能於一身，全功能的完美結合。煮食過程中加入蒸氣，讓烹調的食物不會因烤焗而流失水份。適用於煮各種食物。例如較大的肉類或烤焗濕潤的蛋糕。 | 20 分鐘 / 180°C | 時間 5-239 分鐘 (最長 3 小時 59 分鐘) 溫度 80 - 230°C |
|  | 頂部燒烤 | 適合燒烤食材，或用於烤焗的最後階段，作加強食物金黃度及烤色的作用。 | 25 分鐘 / 110°C | 時間 5-239 分鐘 (最長 3 小時 59 分鐘) 溫度 50 - 230°C |
|  | 底部燒烤 | 適合烘焙的最後階段或局部時段只需底部加熱的食物，如薄餅或馬卡龍等菜式。熱力會從底部散發出來。 | 20 分鐘 / 110°C | 時間 5-239 分鐘 (最長 3 小時 59 分鐘) 溫度 50 - 230°C |
|  | 上下燒烤 | 傳統的一層烘焙與烤焗。熱力會從上面及底部散發出來，使食物達到均勻的烤焗效果。適用於烹調肉類、魚類、麵包以及各式曲奇、糕點及甜品等。尤其適合頂部有濕潤配料的蛋糕。 | 30 分鐘 / 180°C | 時間 5-239 分鐘 (最長 3 小時 59 分鐘) 溫度 50 - 230°C |
|  | 熱風 | 設有風扇在背部，風扇會將背部發熱線產生的熱氣，均勻的送到爐中每一個角落。使多層烤焗的食物受熱更平均。可使用於一層或以上的烤焗。 | 20 分鐘 / 120°C | 時間 5-239 分鐘 (最長 3 小時 59 分鐘) 溫度 50 - 230°C |
|  | 加強熱風對流 | 以較短時間烤焗食物，加快烹調時間。適用於烤焗體積較大的肉類及糕點。 | 25 分鐘 / 180°C | 時間 5-239 分鐘 (最長 3 小時 59 分鐘) 溫度 80 - 230°C |
|  | 熱風對流 | 上下發熱線及背部風扇同時運作，用於各種烤焗菜式，如肉類、海鮮類、薄餅、麵包以及各式曲奇、糕點及甜品等。 | 20 分鐘 / 160°C | 時間 5-239 分鐘 (最長 3 小時 59 分鐘) 溫度 80 - 230°C |

使用前的準備與須知

■ 控制面板 - 主要功能詳細說明

| 圖示 | 模式 | 功能介紹 | 默認時間 / 溫度 | 時間 / 溫度選擇範圍 |
|----|---------|---|---------------|--|
| | 解凍 | 用於解凍冷藏或冷凍食物。 | 20 分鐘 / 50°C | 時間 5 – 239 分鐘 (最長3小時 59 分鐘) 溫度 40 – 60°C |
| | 乾果 | 以低溫熱風去風乾食物，適合製作各種生果片，蔬菜片或肉乾。 | 20 分鐘 / 80°C | 時間5-779分鐘 (最長12小時 59 分鐘) 溫度40-90°C |
| | 預熱 – 蒸氣 | 以蒸氣進行預熱。使爐腔達到預設溫度。 | 100°C | 溫度 50 – 110°C |
| | 預熱 – 烤焗 | 以烤焗進行預熱。使爐腔達到預設溫度。 | 180°C | 溫度 100– 230°C |
| | 除垢 | 當蒸氣模式或其他帶有蒸氣功能模式使用的累計時間達到100個小時，“除垢提示”圖示會亮起，提醒用戶進行除垢模式。需配合除垢劑使用。 | 50 分鐘 | 時間不可調校 溫度不可調校 |
| | 消毒 | 以高溫蒸氣消毒，可消毒餐具或嬰兒奶瓶等。 | 20 分鐘 / 120°C | 時間 10 – 59 分鐘 溫度不可調校 (120°C) |
| | 烘乾爐腔 | 此模式會以高溫加熱爐腔，蒸發爐腔中多餘的水份和蒸氣。此功能適用於任何蒸氣烹調的模式後使用。 | 15 分鐘 / 180°C | 時間不可調校 溫度不可調校 |
| | 保溫 | 以熱風保溫食物。適合把剛煮的食物保溫。 | 20 分鐘 / 40°C | 時間 5-779 分鐘 (最長12小時 59 分鐘) 溫度 30 – 60°C |
| | 發酵 | 此模式以蒸氣運作，使爐腔達至調校的穩定而潮濕的環境。用於麵團發酵，例如薄餅的餅底或製作麵包時的麵團。麵團發酵的速度會比在室溫下快，麵團表面也不會過乾。 | 40 分鐘 / 35°C | 時間 10-779 分鐘 (最長 12 小時 59 分鐘) 溫度 25 – 50°C |
| | DIY 煮食 | 一次性自動完成多達三種不同煮食模式。 | | |

使用前的準備與須知

■ 使用及烹調小貼士

1. 所有烹調模式的最短設定的時間為 5 分鐘。(除追加烹調時間功能外)
2. 完成烹調後，風扇會延時工作 3 分鐘，將爐腔內的熱量排出，這是正常現象。
3. 烹調過程中，如果將爐門打開，蒸焗爐會自動暫停；將爐門關上，則自動啟動並按餘下設定時間及溫度繼續烹調。
4. 加熱湯類、汁類或飲品等液體食物時，取出時必須小心。在烹調時，請留意以下各點：
 - (a) 不要過度加熱。否則在取出食物時，會由於突然沸騰導致液體飛濺而燙傷。
 - (b) 液體食物加熱時，液體不要多於容器的八成滿。因為加熱少量液體食物會由於沸騰而導致液體突然飛濺。
 - (c) 加熱前或加熱途中請攪拌。
 - (d) 加熱後，先讓食物在爐內放置片刻，略加攪拌後取出。
 - (e) 使用奶瓶或加熱嬰兒食物後，即攪拌或搖動，餵食前應檢查溫度，避免燙傷。
5. 如要在烹調過程中，檢查食物溫度，必須使用焗爐專用的溫度計檢查。如果食物烹調時間不足則再放入爐內繼續烹調。
6. 烤焗完成後，建議立刻取出以免殘留熱量使食物過熱或使烤色變深。
7. 烤焗過程中為維持爐內溫度，請儘量避免開關爐門檢查食物，以免影響爐內溫度。如於煮食過程中曾打開爐門，請相應地增加烹食時間。
8. 如果擔心烤色不均勻，請在加熱途中調整或翻轉食物、蒸焗盤的位置或方向。
9. 配件擺放技巧
 - 單層煮食：建議放置配件在第 2 層
 - 兩層煮食：建議放置配件在第 2 和第 1 層
 - 三層煮食：建議放置配件在第 1、第 2 和第 3 層

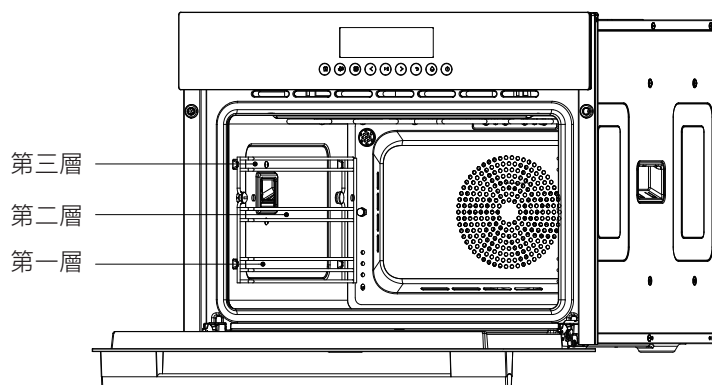

以上建議擺放層數、位置僅供參考。客人可因應食物份量、種類和存放食物的容器，去調整擺放配件的層數和位置。

操作方法說明

■ 設置時鐘

首次開機後，蒸焗爐發出「必」一聲後即進入待機畫面，時鐘默認顯示 12:00（如下圖），顯示屏全亮。



在開機後畫面後，若在 5 分鐘內沒有進行任何操作，會自動進入省電模式，此時顯示屏熄滅，省電模式下只有電源鍵能操作。省電模式下按“電源鍵”退出省電模式，機器進入開機後畫面。

例如：設置現前時間為 13 時 20 分。

操作步驟：

1. 在待機畫面下，長按設置鍵  3 秒，小時位閃爍（如下圖）；



2. 按 < > 鍵直到顯示小時位轉至 13，按  確認。（如下圖）然後畫面會自動跳至分鐘選項。



3. 按 < > 鍵直到顯示分鐘轉至 20，按  確認。（如下圖）



4. 完成時間設置。（如下圖）



注意：在設置過程中，若連續 5 分鐘內用戶沒有任何操作，當前所有設置將會被取消並返回到待機畫面，進入待機狀態。

操作方法說明

■ 蒸氣模式

此模式以蒸氣烹調食物，可保留食物原有的味道，營養及顏色。適合蒸煮蔬菜，肉類，海鮮或燉湯等。每次使用前，請確保水箱已加滿水。

| | 溫度 | 時間 |
|------|--------------|-------------------|
| 開機預設 | 100°C | 20 分鐘 |
| 設定範圍 | 50°C - 110°C | 5 分鐘 - 6 小時 59 分鐘 |

例如：設置烹調時間為 1 小時 40 分鐘，溫度為 90°C。

操作步驟：

1. 在待機狀態下，按 > 鍵  蒸氣模式圖示閃爍，按 ▷|00 確認功能。(如下圖) 然後畫面會自動跳至小時選項。



2. 按 < > 鍵直到顯示小時位轉至 01，按 ▷|00 確認。(如下圖) 然後畫面會自動跳至分鐘選項。



3. 按 < > 鍵直到顯示分鐘轉至 40，按 ▷|00 確認。(如下圖) 然後畫面會自動跳至溫度選項。



4. 按 < > 鍵直到顯示溫度轉至 90°C，按 ▷|00 確認。(如下圖)



5. 設置完成，開始烹調。

操作方法說明

■ 熱風加蒸氣模式

以熱風煮食並加入蒸氣，讓烹調的食物不會因烤焗的高溫而流失水份。背部風扇使熱風均勻循環流動，可確保多層烤焗的食物受熱更平均。適用於煮各種食物。可把食物放在鋪有錫紙或牛油紙的焗盤上直接烤焗。每次使用前，請確保水箱已加滿水。

| | 溫度 | 時間 |
|------|--------------|-------------------|
| 開機預設 | 120°C | 30 分鐘 |
| 設定範圍 | 80°C – 200°C | 5 分鐘 – 3 小時 59 分鐘 |

例如：設置烹調時間為 40 分鐘，溫度為 210°C。

操作步驟：

1. 在待機狀態下，按 > 鍵至  熱風加蒸氣模式圖示閃爍，按 ▷|00 確認功能。(如下圖) 然後畫面會自動跳至小時選項。



2. 按 ▷|00 確認小時位 00 設定。(如下圖) 然後畫面會自動跳至分鐘選項。



3. 按 < > 鍵鈕直到顯示分鐘轉至 40，按 ▷|00 確認。(如下圖) 然後畫面會自動跳至溫度選項。



4. 按 < > 鍵直到顯示溫度轉至 210°C，按 ▷|00 確認。(如下圖)



5. 設置完成，開始烹調。

操作方法說明

■ 全功能蒸焗模式

此模式集合上下火、熱風、蒸氣功能於一身，全功能的完美結合。煮食過程中加入蒸氣，讓烹調的食物不會因烤焗而流失水份。適用於煮各種食物。例如較大的肉類或烤焗濕潤的蛋糕。可把食物放在鋪有錫紙或牛油紙的焗盤上直接烤焗。每次使用前，請確保水箱已加滿水。

| | 溫度 | 時間 |
|------|--------------|-------------------|
| 開機預設 | 180°C | 20 分鐘 |
| 設定範圍 | 80°C – 230°C | 5 分鐘 – 3 小時 59 分鐘 |

例如：設置烹調時間為 40 分鐘，溫度為 210°C

操作步驟：

1. 在待機狀態下，按 > 鍵至  全功能蒸焗模式圖示閃爍，按 ▷|◁ 確認功能。(如下圖) 然後畫面會自動跳至小時選項。



2. 按 ▷|◁ 確認小時位 00 設定。(如下圖) 然後畫面會自動跳至分鐘選項。



3. 按 < > 鍵直到顯示分鐘轉至 40，按 ▷|◁ 確認。(如下圖) 然後畫面會自動跳至溫度選項。



4. 按 < > 鍵直到顯示溫度轉至 210°C，按 ▷|◁ 確認。(如下圖)



5. 設置完成，開始烹調。

操作方法說明

■ 頂部 / 底部 / 上下燒烤模式

設有三種不同的燒烤模式，分別為頂部燒烤模式，底部燒烤模式和上下燒烤模式（頂部及底部燒烤）。可因應食材種類和所需的烹調效果去選擇合適的燒烤模式。可把食物放在鋪有錫紙或牛油紙的燒烤架或焗盤上直接烤焗。

頂部燒烤模式：適合燒烤食材或用於烤焗的最後階段，作加強食物金黃度及烤色的作用。

底部燒烤模式：適合烘焙的最後階段或局部時段只需底部加熱的食物，如薄餅或馬卡龍等菜式。熱力會從底部散發出來。

上下燒烤模式：傳統的一層烘焙與烤焗。熱力會從上面及底部散發出來，使食物達到均勻的烤焗效果。適用於烹調肉類、魚類、麵包以及各式曲奇、糕點及甜品等。尤其適合頂部有濕潤配料的蛋糕。

1) 頂部 / 底部 燒烤模式

| | 溫度 | 時間 |
|------|--------------|-------------------------------|
| 開機預設 | 180°C | 25分鐘 (頂部燒烤模式) / 20分鐘 (底部燒烤模式) |
| 設定範圍 | 50°C – 230°C | 5分鐘 – 3小時59分鐘 |

例如：設置烹調時間為 40 分鐘，溫度為 210°C。

操作步驟：

1. 在待機狀態下，按 > 鍵至 或 所需燒烤模式圖示閃爍，按 ▷ 確認功能。(如下圖) 然後畫面會自動跳至小時選項。

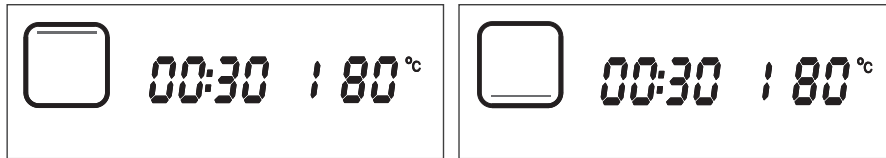

2. 按 ▷ 確認小時位 00 設定。(如下圖) 然後畫面會自動跳至分鐘選項。

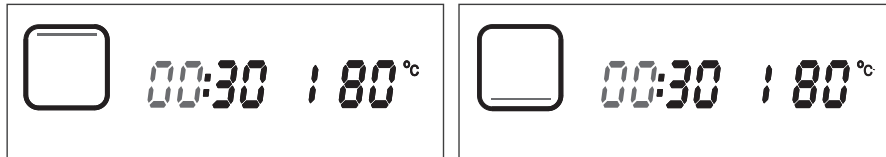

3. 按 < > 鍵直到顯示分鐘轉至 40，按 ▷ 確認。(如下圖) 然後畫面會自動跳至溫度選項。

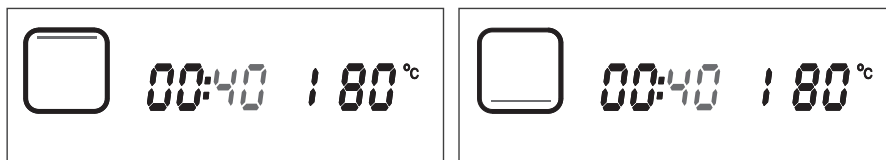

4. 按 < > 鍵直到顯示溫度轉至 210°C，按 ▷ 確認。(如下圖)

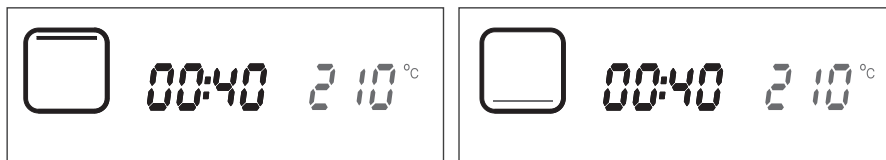

5. 設置完成，開始烹調。

操作方法說明

II) 上下燒烤模式

| | 溫度 | 時間 |
|------|--------------|---------------|
| 開機預設 | 180°C | 30分鐘 |
| 設定範圍 | 50°C – 230°C | 5分鐘 – 3小時59分鐘 |

例如:設置烹調時間為 40 分鐘，頂部發熱管溫度為 200°C，底部發熱管溫度為 180°C。

操作步驟:

1. 在待機狀態下，按 > 鍵至  上下燒烤燒烤模式圖示閃爍，按  確認功能。(如下圖) 然後畫面會自動跳至小時選項。



2. 按  確認小時位 00 設定。(如下圖) 然後畫面會自動跳至分鐘選項。



3. 按 < > 鍵直到顯示分鐘轉至 40，按  確認。(如下圖) 然後畫面會自動跳至溫度選項。



4. 按 < > 鍵直到頂部發熱管顯示溫度轉至 210°C，按  確認。(如下圖)



5. 按 < > 鍵直到底部發熱管顯示溫度轉至 180°C，按  確認。(如下圖)



6. 設置完成，開始烹調。

操作方法說明

■ 熱風模式

設有風扇在背部，風扇會將背部發熱線產生的熱氣，均勻地送到爐中每一個角落。使多層烤焗的食物受熱更平均。可使用於一層或以上的烤焗。可把食物放在鋪有錫紙或牛油紙的焗盤上直接烤焗。

| | 溫度 | 時間 |
|------|--------------|-------------------|
| 開機預設 | 120°C | 20 分鐘 |
| 設定範圍 | 50°C – 230°C | 5 分鐘 – 3 小時 59 分鐘 |

例如：設置烹調時間為 40 分鐘，溫度為 210°C。

操作步驟：

1. 在待機狀態下，按 > 鍵至  熱風模式圖示閃爍，按 ▷00 確認功能。(如下圖) 然後畫面會自動跳至小時選項。

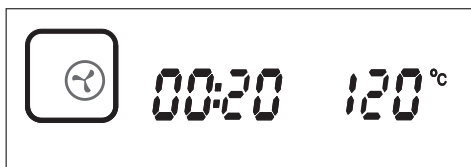

2. 按 ▷00 確認小時位 00 設定。(如下圖) 然後畫面會自動跳至分鐘選項。



3. 按 < > 鍵直到顯示分鐘轉至 40，按 ▷00 確認。(如下圖) 然後畫面會自動跳至溫度選項。

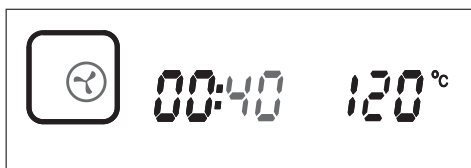

4. 按 < > 鍵直到顯示溫度轉至 210°C，按 ▷00 確認。(如下圖)



5. 設置完成，開始烹調。

操作方法說明

■ 加強熱風對流模式

以較短時間烤焗食物，加快烹調時間。適用烤焗體積較大的肉類及糕點。建議把食物放在鋪有錫紙或牛油紙的焗盤上直接烤焗。

| | 溫度 | 時間 |
|------|--------------|-------------------|
| 開機預設 | 180°C | 25 分鐘 |
| 設定範圍 | 80°C – 230°C | 5 分鐘 – 3 小時 59 分鐘 |

例如：設置烹調時間為 40 分鐘，溫度為 210°C。

操作步驟：

1. 在待機狀態下，按 > 鍵至  加強熱風對流模式圖示閃爍，按 ▷00 確認功能。(如下圖) 然後畫面會自動跳至小時選項。



2. ▷00 確認小時位 00 設定。(如下圖) 然後畫面會自動跳至分鐘選項。



3. 按 < > 鍵直到顯示分鐘轉至 40，按 ▷00 確認。(如下圖) 然後畫面會自動跳至溫度選項。



4. 按 < > 鍵直到顯示溫度轉至 210°C，按 ▷00 確認。(如下圖)



5. 設置完成，開始烹調。

操作方法說明

■ 熱風對流模式

上下發熱線及背部風扇同時運作，用於各種烤焗菜式，如肉類、海鮮類、薄餅、麵包以及各式曲奇、糕點及甜品等。可把食物放在鋪有錫紙或牛油紙的燒烤架或焗盤上直接烤焗。

| | 溫度 | 時間 |
|------|--------------|-------------------|
| 開機預設 | 160°C | 20 分鐘 |
| 設定範圍 | 80°C – 230°C | 5 分鐘 – 3 小時 59 分鐘 |

例如：設置烹調時間為 40 分鐘，頂部發熱管溫度為 210°C，底部發熱管溫度為 180°C。

操作步驟：

1. 在待機狀態下，按 > 鍵  至熱風對流模式圖示閃爍，按 ▷| 確認功能。(如下圖) 然後畫面會自動跳至小時選項。



2. 按 ▷| 確認小時位 00 設定。(如下圖) 然後畫面會自動跳至分鐘選項。



3. 按 < > 鍵直到顯示分鐘轉至 40，按 ▷| 確認。(如下圖) 然後畫面會自動跳至溫度選項。



4. 按 < > 鍵直到顯示頂部發熱管溫度轉至 210°C，按 ▷| 確認。(如下圖)



5. 按 < > 鍵直到顯示底部發熱管溫度轉至 180°C，按 ▷| 確認。(如下圖)

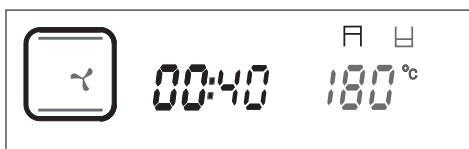

6. 設置完成，開始烹調。

操作方法說明

■ 解凍模式

以蒸氣去解凍冷藏或冷凍食物。每次使用前，請確保水箱已加滿水。

| | 溫度 | 時間 |
|------|-------------|-------------------|
| 開機預設 | 50°C | 20 分鐘 |
| 設定範圍 | 40°C – 60°C | 5 分鐘 – 3 小時 59 分鐘 |

例如：設置烹調時間為 1 小時 40 分鐘，溫度為 60°C。

操作步驟：

1. 在待機狀態下，按 < 鍵至  解凍模式圖示閃爍，按 ▷| 確認功能。（如下圖）然後畫面會自動跳至小時選項。



2. 按 < > 鍵直到顯示小時位轉至 01，按 ▷| 確認。（如下圖）然後畫面會自動跳至分鐘選項。



3. 按 < > 鍵直到顯示分鐘轉至 40，按 ▷| 確認。（如下圖）然後畫面會自動跳至溫度選項。



4. 按 < > 鍵直到顯示溫度轉至 60°C，按 ▷| 確認。（如下圖）



5. 設置完成，開始烹調。（如下圖）



操作方法說明

■ 乾果模式

以低溫熱風抽乾食物，適合製作各種生果片，蔬菜片或肉乾。

| | 溫度 | 時間 |
|------|-------------|--------------------|
| 開機預設 | 80°C | 20 分鐘 |
| 設定範圍 | 40°C - 90°C | 5 分鐘 - 12 小時 59 分鐘 |

例如：設置烹調時間為 2 小時，溫度為 90°C。

操作步驟：

1. 在待機狀態下，按 < 鍵至  乾果模式圖示閃爍，按 ▷| 確認功能。（如下圖）然後畫面會自動跳至小時選項。



2. 按 < > 鍵直到顯示小時位轉至 02，按 ▷| 確認。（如下圖）然後畫面會自動跳至分鐘選項。



3. 按 ▷| 確認分鐘位 00 設定。（如下圖）然後畫面會自動跳至溫度選項。

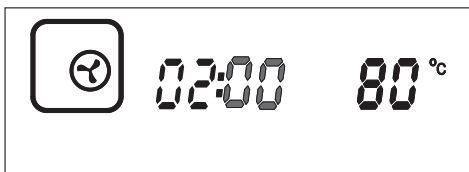

4. 按 < > 鍵直到顯示溫度轉至 90°C，按 ▷| 確認。（如下圖）



5. 設置完成，開始烹調。（如下圖）



操作方法說明

■ 預熱模式

預熱模式有蒸氣和烤焗兩種預熱模式選擇，使爐腔達至預設溫度。

| | 蒸氣預熱 | 烤焗預熱 |
|------|--------------|---------------|
| | 溫度 | 溫度 |
| 開機預設 | 100°C | 180°C |
| 設定範圍 | 50°C – 110°C | 100°C – 230°C |

兩種預熱功能的烹調時間均毋需設定；當達到設定的預熱溫度時，會發出聲效提示操作已完成。預熱進行中，顯示之時間為現在時間。如進行蒸氣預熱，每次使用前，請確保水箱已加滿水。

I) 蒸氣預熱模式

例如：以蒸氣進行預熱，設置烹調溫度為 100°C。

操作步驟：

1. 在待機狀態下，按 < 鍵至  預熱模式圖示閃爍，01是蒸氣模式，按 ▷ 確認功能。（如下圖）



2. 此時自動進入烹調溫度的設置；按 ▷ 確認預設溫度 100°C 的設定。（如下圖）



3. 設置完成，開始預熱。（如下圖）



操作方法說明

II) 烤焗預熱模式

例如：以烤焗進行預熱，設置烹調溫度為 200°C。

操作步驟：

1. 在待機狀態下，按 < 鍵至  預熱模式圖示閃爍，02是烤焗模式。
按 ▷ 確認功能。(如下圖)



2. 此時自動進入烹調溫度的設置；按 < > 鍵直到顯示溫度轉至200°C，按 ▷ 確認。(如下圖)



3. 設置完成，開始預熱。(如下圖)



預熱結束時蒸焗爐會發出聲效提示操作已完成。預熱完成後，客人可以根據需要，選擇其他烹調模式進行烹調。

注意：“烹調過程中調校/ 結束後追加時間功能”功能不適用於此模式。

操作方法說明

■ 發酵模式

此模式以蒸氣運作，使爐腔達至已調校的穩定而潮濕的環境。用於麵糰發酵：如薄餅的餅底或製作麵包的麵糰。麵糰發酵速度會較室溫下快，麵糰表面也不會過乾。每次使用前，請確保水箱已加滿水。

| | 溫度 | 時間 |
|------|-------------|--------------------|
| 開機預設 | 35°C | 40 分鐘 |
| 設定範圍 | 25°C – 50°C | 10分鐘 – 12 小時 59 分鐘 |

例如：設置烹調時間為 50 分鐘，溫度為 35°C。

操作步驟：

1. 在待機狀態下，按 < 鍵至  發酵模式圖示閃爍，按旋鈕 ▷00 功能。(如下圖) 然後畫面會自動跳至小時選項。



2. 按 ▷00 確認小時位 00 設定。(如下圖) 然後畫面會自動跳至分鐘選項。



3. 按 < > 鍵直到顯示分鐘轉至 40，按 ▷00 確認。(如下圖) 然後畫面會自動跳至溫度選項。



4. 按 ▷00 確認預設溫度 35°C 的設定。(如下圖)



5. 設置完成，開始烹調。(如下圖)



操作方法說明

■ 保溫模式

以熱風保溫食物，適合將剛煮的食物保溫。

| | 溫度 | 時間 |
|------|-------------|--------------------|
| 開機預設 | 40°C | 20 分鐘 |
| 設定範圍 | 30°C – 60°C | 5 分鐘 – 12 小時 59 分鐘 |

例如：設置烹調時間為 1 小時 30 分鐘，溫度為 60°C。

操作步驟：

1. 在待機狀態下，按 < 鍵至  保溫模式圖示閃爍，按 ▷ 確認功能。(如下圖)然後畫面會自動跳至小時選項。



2. 按 < > 鍵直到顯示小時位轉至 01，按 ▷ 確認。(如下圖)然後畫面會自動跳至分鐘選項。



3. 按 ▷ 確認分鐘位 30 的設定。(如下圖)然後畫面會自動跳至溫度選項。



4. 按 < > 鍵直到顯示溫度轉至 60°C，按 ▷ 確認。(如下圖)



5. 設置完成，開始烹調。(如下圖)





操作方法說明

■ 除垢模式



長期使用蒸氣功能會導致機內及水管內產生水垢。

當累積使用蒸氣模式或其他帶有蒸氣功能模式的時間達到100個小時，顯示屏上  除垢提示圖示會亮起，提醒用戶進行除垢模式。直至用戶啟動除垢模式後，圖示才會熄滅。

除垢模式分兩個階段：除垢階段、清洗階段。當需要倒掉接水盤內的污水時，顯示屏上  會相應亮起來提醒用戶。

除垢模式需配合除垢劑使用。客人可選用惠而浦獨家推出的Wpro除鈣去垢劑，此產品適用於蒸爐，有效清空蒸爐管道內的鈣化聚積物和保持機器良好的操作性能。詳情可到印在說明書封面上的網站了解。

進行除垢模式時，建議使用除垢劑和淨水分量如下：

第 1 階段：除垢，時間為 40 分鐘。建議使用 30 毫升除垢劑和 300 毫升淨水。

第 2 階段：除垢清潔，時間為 10 分鐘。建議使用 300 毫升淨水。

| | 溫度 | 時間 |
|------|------|-------|
| 開機預設 | 不可調校 | 50 分鐘 |
| 設定範圍 | 不可調校 | 不可調校 |

操作步驟：

1. 第 1 個階段：除垢

- 先將 30 毫升除垢劑和 300 毫升淨水倒入水箱。
- 在待機狀態下，按 < > 鍵至  除垢模式圖示亮起，按 ▷00 確認功能。(如下圖)



- 開始除垢模式。(如下圖)

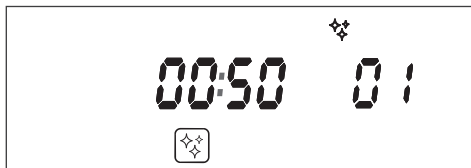

- 第 1 個階段需時 40 分鐘，程式完成後，顯示屏上的時間位會閃動，並發出聲效去提示第 1 個階段完成。同時顯示屏上  清潔廢水箱圖示會亮起，提醒用戶倒掉廢水箱內的污水。
- 請倒掉污水，並將廢水箱放回機內。



操作方法說明

2 第 2 個階段: 除垢清潔

- A. 打開爐門，將 300 毫升淨水倒入水箱。
- B. 將水箱放回機內並關上爐門，程式會自動啟動，繼續除垢清潔工作。
- C. 第 2 個階段完成後，顯示屏會顯示“End”提示，並發出聲效提示，同時顯示屏上  接水盤圖示會亮起，提醒用戶倒掉接水盤內的污水。
- D. 請倒掉污水。

3. 除垢完成。

注意：1. 組合鍵：“爐腔溫度顯示”功能不適用於此模式。

2. “烹調過程中調校 / 結束後追加時間”功能不適用於此模式。

3. 除垢過程中，如操作有誤（包括操作過程中按暫停或沒有按指示下開關爐門等），除垢模式程式會被擾亂而無法正常運作。建議重新啟動除垢模式並按照除垢模式中的指示再次操作。

操作方法說明

■ 消毒模式



以 110°C 高溫蒸氣消毒，可消毒餐具或嬰兒奶瓶等。每次使用前，請確保水箱已加滿水。

| | 溫度 | 時間 |
|------|-------|---------------|
| 開機預設 | 120°C | 20 分鐘 |
| 設定範圍 | 不可調校 | 10 分鐘 - 59 分鐘 |

例如：設置烹調時間為 35 分鐘。

操作步驟：

1. 在待機狀態下，按 < > 鍵至  消毒模式圖示閃爍，按 ▷|00 確認功能。(如下圖) 然後畫面會自動跳至分鐘選項。



2. 按 ▷|00 確認小時位 00 設定。(如下圖) 然後畫面會自動跳至分鐘選項。



3. 按 < > 鍵直到顯示分鐘轉至 35，按 ▷|00 確認。(如下圖)



4. 設置完成，開始烹調。(如下圖)



操作方法說明

■ 烘乾爐腔模式



此模式會以高溫加熱爐腔，蒸發爐腔中多餘水份及蒸氣。此功能適用於任何以蒸氣烹調的模式後使用。

| | 溫度 | 時間 |
|------|-------|-------|
| 開機預設 | 180°C | 15 分鐘 |
| 設定範圍 | 不可調校 | 不可調校 |

操作步驟：

1. 在待機狀態下，按 < 鍵至  烘乾爐腔模式圖示閃爍，按 > 確認功能。(如下圖)

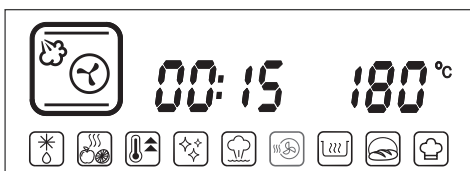

2. 開始烹調。(如下圖)



注意：1.“組合鍵：爐腔溫度顯示”功能不適用於此模式。

2.“烹調過程中調校 / 結束後追加時間”功能不適用於此模式。

操作方法說明

■ DIY 煮食模式

用於一次性自動完成多種不同的煮食功能組合模式，使食物製作更多樣化和方便。

例如：先用熱風加蒸模式溫度 180°C 烹調時間10分鐘，結束後接着用純蒸溫度 100°C 烹調時間 10 分鐘，結束後再以熱風模式溫度 180°C 烹調時間 20 分鐘。

操作步驟：

1. 在待機狀態下，按 < 鍵至  模式圖示閃爍，按 ▷|◁ 確認功能。(如下圖) 然後畫面會跳至煮食模式選項。



2. 按 > 鍵至  熱風加蒸模式圖示閃爍，按 ▷|◁ 確認功能 (如下圖) 然後畫面會自動跳至小時選項。

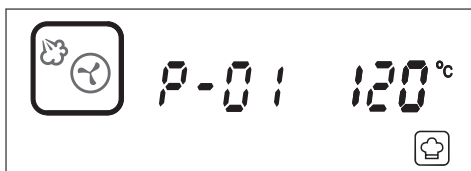

3. 按 ▷|◁ 確認小時位00設定。(如下圖) 然後畫面會自動跳至分鐘選項。



4. 按 < > 鍵直到顯示轉至 10，按 ▷|◁ 確認。(如下圖) 然後畫面會自動跳至溫度選項。



5. 按 < > 鍵直到顯示溫度轉至 180°C，按  確認並跳至下一個設定模式。(如下圖)



6. 按 > 鍵至  純蒸模式圖示閃爍，按 ▷|◁ 確認功能 (如下圖) 然後畫面會自動跳至小時選項。

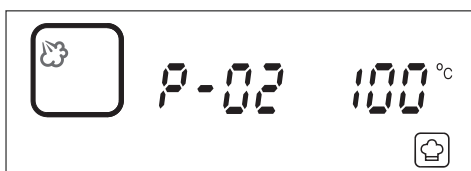

操作方法說明

7. 按 \triangleright 確認小時位00設定。(如下圖) 然後畫面會自動跳至分鐘選項。



8. 按 $<$ $>$ 鍵直到顯示轉至 10，按 \triangleright 確認。(如下圖) 然後畫面會自動跳至溫度選項。



9. 按 $<$ $>$ 鍵直到顯示溫度轉至 100°C，按 🕒 確認並跳至下一個設定模式。(如下圖)



10. 按 $>$ 鍵至熱風模式圖示閃爍，按 \triangleright 確認功能 (如下圖) 然後畫面會自動跳至小時選項。

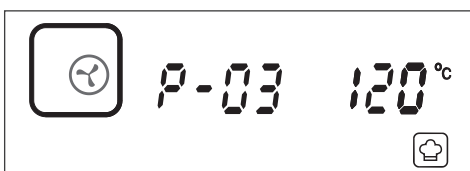

11. 按 \triangleright 確認小時位00設定。(如下圖) 然後畫面會自動跳至分鐘選項。



12. 按 $<$ $>$ 鍵直到顯示轉至 20，按 \triangleright 確認。(如下圖) 然後畫面會自動跳至溫度選項。



13. 按 $<$ $>$ 鍵直到顯示溫度轉至 180°C，按 \triangleright 確認並完成設定。



14. 設置完成，開始烹調。



操作方法說明

■ 預約功能

在進行預約功能設定前，必須先完成時鐘設定。時鐘設定可參見本說明書第 12 頁“設置時鐘”內說明。

例如：現時時間為 15:50，設置預約底部燒烤模式，烹調時間為 40 分鐘，溫度為 210°C，結束時間為 18:00。

操作步驟：

1. 在待機狀態下，按 > 鍵至  底部燒烤模式圖示亮起，按  確認功能。(如下圖) 然後畫面會自動跳至小時選項。



2. 按  確認小時位 00 設定。(如下圖) 然後畫面會自動跳至分鐘選項。



3. 按 < > 鍵直到顯示分鐘轉至 40，按  確認。(如下圖) 然後畫面會自動跳至溫度選項。



4. 按 < > 鍵直到顯示溫度轉至 210°C，按時間鍵  確認。(如下圖)



5. 此時畫面會進入預約烹調結束時間的小時位設置，時鐘位顯示的時間會切換至最早可完成烹調結束時間16:30 小時位“16”會閃爍；同時，顯示屏上方  預約功能圖示會閃爍顯示，表示正在進行預約功能設定。(如下圖)

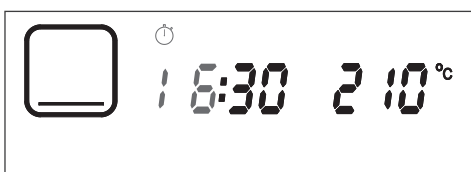

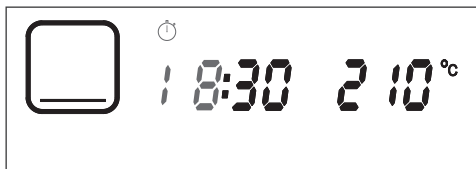

操作方法說明

6. 按 < > 鍵直到小時位轉至 18，按 ▷|00 確認。(如下圖) 然後畫面會自動跳至分鐘選項。

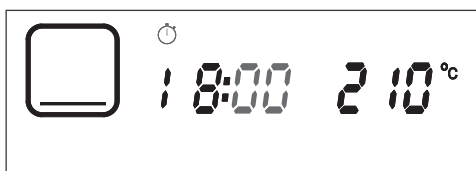

7. 按 < > 鍵直到顯示分鐘轉至 00，按 ▷|00 確認。



8. 顯示屏上  預約功能圖示會亮起，預約烹調時間切換回現時時間 15:50。表示預約設置完成。(如下圖)



* 爐燈亮起 3 分鐘後會自動關閉

取消預約設定：

如需取消預約設定，可直接按  電源鍵，即退出預約設定，並自動返回到待機畫面。

注意：預約模式適用於 9 個主要烹調模式。(詳情請參閱第 8-10 頁控制面板 – 主要功能介紹 / 詳細說明)

建議：預約設置後，可啟動兒童安全鎖功能，以防止不小心觸摸到控制面板而誤將預約取消。童鎖設置可參見本說明書第 7 頁“控制面板 – 基本功能說明”內說明。當達到預約的啟動時間，蒸焗爐會正常啟動，不受童鎖影響。

操作方法說明

■ 烹調過程中調校 / 結束後追加時間功能

A. 烹調過程中進行調校

在烹調過程中，可以根據需要去增加或減少烹調時間和溫度。

例如：已設定的烹調時間 01:40 和溫度 90°C，改為烹調時間 02:00 及溫度 100°C。

操作步驟：

1. 於烹調過程中，按  暫停烹調，時間位會閃爍。(如下圖)



2. 按 < > 鍵直到顯示小時位轉至 02 (如下圖)，按返回鍵  確認，然後畫面會自動跳至溫度選項。



3. 按 < > 鍵直到溫度轉至 100°C (如下圖)，按返回鍵  確認，然後畫面會自動跳至分鐘選項。



4. 按 < > 鍵直到顯示分鐘轉至 00，按  確認。(如下圖)



5. 設置完成，開始新設置的烹調設定。(如下圖)



操作方法說明

B. 烹調過程結束後追加功能

在烹調過程結束後，可以根據需要去增加烹調時間。

| | 溫度 | 時間 |
|------|----------|-----------|
| 設定範圍 | 根據煮食模式範圍 | 1分鐘 -59分鐘 |

烹調過程結束後，顯示屏會顯示“End”並發出聲效提示。同時顯示屏上  增加烹調時間圖示會亮起。

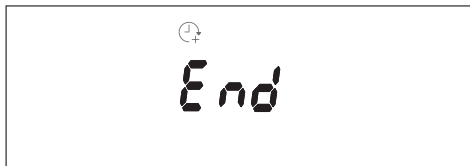



如增加烹調時間，可根據以下步驟操作：

例如：烹調結束後，追加烹調時間 3 分鐘，溫度為90°C。

操作步驟：

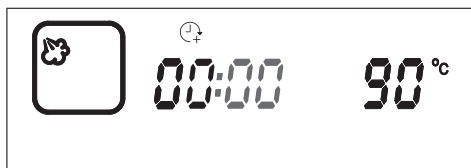
1. 按  確認追加時間功能，顯示屏會自動跳至分鐘位選項。(如下圖)



2. 按 < > 鍵直到顯示分鐘轉至 03，按  確認。(如下圖)

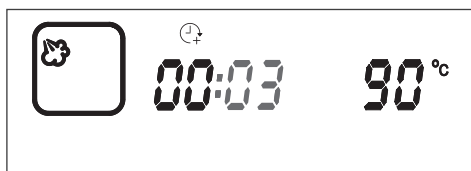

3. 顯示屏會自動跳至溫度選項，按  確認。(如下圖)



4. 設置完成，即啟動追加時間烹調。(如下圖)



注意：如果用戶在烹調結束後，3 分鐘內沒有進行任何操作，將自動返回到待機狀態。

操作方法說明

■ 餘溫高溫提示 H

在待機狀態或省電模式狀態下，完成煮食後，只要爐腔內的溫度高於50°C，顯示屏上 H 高溫提示圖標就會亮起，提醒用戶爐腔內溫度較高，不適宜進行清潔（如下圖）。直到爐腔內的溫度低於50°C，顯示屏上高溫提示圖標才會消失，建議用戶於圖示消失後才進行清潔。



■ 童鎖功能 童鎖圖示

用來鎖住按鍵，防止兒童在沒有成人指導的情況下使用蒸焗爐。

A. 啟動童鎖：

可長按 童鎖鍵 3 秒鐘，進入童鎖狀態，此時顯示屏上方的童鎖圖示亮起。（如下圖）



B. 解除童鎖

長按 童鎖鍵 3 秒鐘，即可解除童鎖，此時顯示屏上方的童鎖圖示會消失。

清潔及保養

■ 清潔保養

1. 在正常情況下，清潔產品是唯一所需的保養方法。
2. 請務必在蒸焗爐冷卻狀態下，圖示消失後進行清潔與保養。清潔之前，需切斷電源。請勿使用蒸氣清潔器清洗本蒸焗爐。
3. 蒸焗爐必須保持清潔，否則可能導致爐身受到腐蝕，縮短蒸焗爐的使用壽命，所以每次使用蒸焗爐後，必須進行清潔。
4. 切勿使用含金屬成份的清潔布、磨砂型潔具、鋼刷、表面粗糙的抹布，否則會對爐身表面、爐門、控制面板、爐內壁及配件造成損害。應以沾有溫和洗潔精的海綿或軟布或噴上玻璃清潔劑的廚房紙巾進行清潔。每次使用後，確保爐腔（包括爐腔底部）是乾透。
5. 鹽份是具侵蝕性的物質，一旦積聚在爐腔內，將形成銹漬。一些帶酸性的醬汁，例如茄汁、芥末和醃製食品含有氯和酸的化學成份。而該等成份會對鋼表面造成影響。所以建議每次使用蒸焗爐後，必須進行清潔。
6. 切勿讓油脂及食物碎屑殘留於爐門及爐門封邊上。假如爐門封邊清潔處理不善，或會影響蒸焗爐操作時，爐門無法完全關上，繼而導致機前方及兩側部份損壞。
7. 每次使用後，
 - i) 清理蒸焗爐門底下的黑色接水盤的積水，以防止積水滿瀉，濺濕及弄髒地面。
 - ii) 清理殘留在水箱未用完的水。
 - iii) 每次使用後，打開爐門 15-30 分鐘或進行烘乾爐腔模式，以風乾爐腔及門框。
8. 如果爐腔非常骯髒，可於清潔前，先以「消毒模式」（120°C），蒸煮 30分鐘，來溶解油漬，待機身冷卻後，才開始進行清潔。如遇上頑固的油漬，可重覆以上的步驟。切勿使用含金屬成份的清潔布、磨砂型潔具、鋼刷、表面粗糙的抹布清潔。
9. 建議最少每一個月或除垢圖示亮起時進行“除垢模式”清潔。
10. 建議使用飲用食水或蒸餾水作烹調用，但避免使用礦泉水。
11. 水箱必須每月至少檢查一次。如有需要，取出水箱，擦洗乾淨後再放回原處。
12. 每次使用後，應清潔和風乾爐腔（包括爐腔頂部，左右兩側和底部）。如爐底或爐腔有變黃的情況，可以使用不銹鋼清潔劑去除污漬。（例如：Wpro 不銹鋼清潔劑）
13. 蒸焗爐腔可能會出現異味，如需清除異味，可以在爐腔內放置5 - 6片檸檬，使用蒸氣功能，設置100°C操作15 - 20 分鐘，結束後即可清除異味。
烹調完畢，需清理接水板中殘留的水。蒸焗爐若長時間不使用，清潔乾淨爐腔後應放在通風乾燥，沒有腐蝕性氣體的環境中。
蒸焗爐發生故障時，必須由本廠培訓的專業維修人員檢修，其它任何人拆修將是危險的。爐燈必須斷開電源，打開機殼，爐燈要採用本公司的專用型號。

清潔及保養

■ 層架拆卸與安裝

1. 順時針擰下導軌前端的螺絲

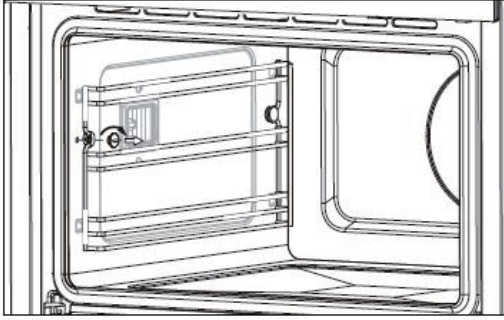

註：拆卸前端螺絲時請務必注意擰動方向。錯誤的拆卸會導致與前端螺絲連接的鎖緊結構被破壞，造成前端螺絲無法正常拆裝。

2. 將層架導軌拉到爐腔內部，在前方拿下

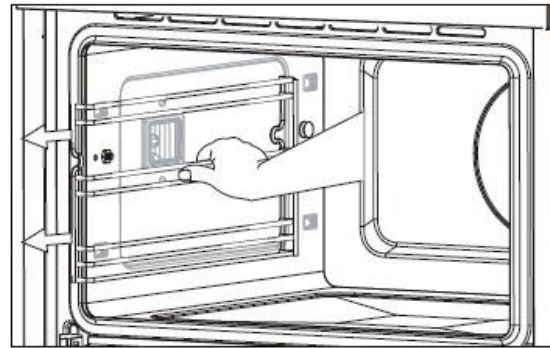
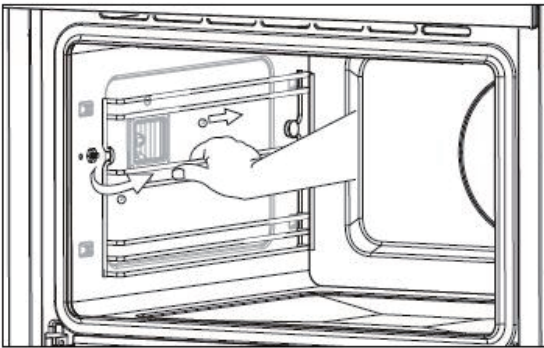

3. 要把層架安裝牢固，需將其插入後端的螺絲，然後將其前端的螺絲逆時針擰緊

清潔及保養

■ 內隔熱罩拆卸與安裝

1. 用合適的套筒套住固定內隔熱罩的螺絲，逆時針擰動，可拆下螺絲，取出內隔熱罩

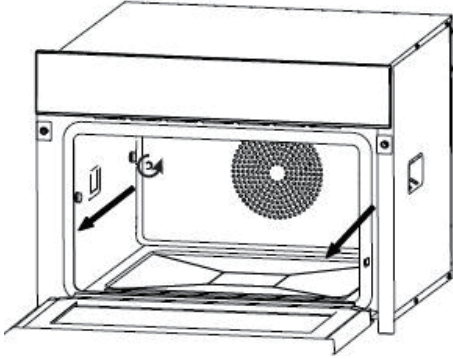

2. 將內隔熱罩水平地放入爐腔內，安放於爐腔後板對應的螺絲上，用2顆螺絲順時針方向擰緊，確保牢固

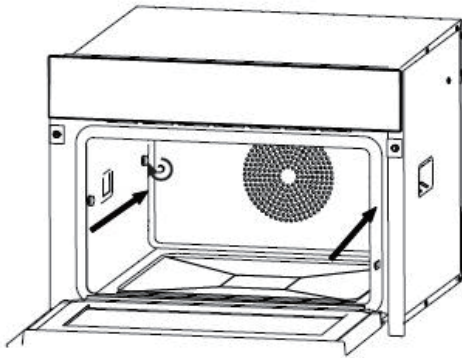



注意：1. 在扣合的時候，用雙母指並需要稍微用力往後壓，以便鋼架扣位更加容易扣回固定件。

2. 需確保爐腔冷卻，H圖標消失後，才進行清潔。

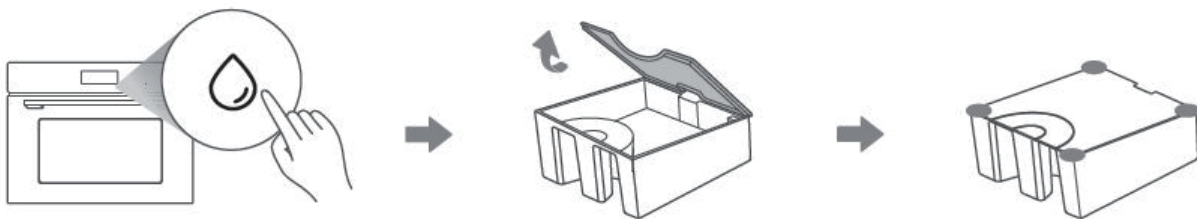
■ 水箱的拆卸與安裝



操作過程：

1. 按  鍵將面板升起，取出水箱
2. 打開水箱蓋並清潔
3. 裝上水箱蓋，請按壓圖中灰色點位確保貼合好
4. 將水箱放回原位，按  鍵將面板降下

其他須知

■ 故障排解

A. 如出現以下情況 如出現以下情況

| | 如以下情況出現... | 可能成因 | 解決方法 |
|---|-------------|----------------|-----------------|
| 1 | 顯示屏上顯示消失 | 蒸焗爐沒有連接到電源 | 確保蒸焗爐連接電源 |
| | | 插座有問題 | 用其他電器再測試插座是否有問題 |
| | | 電源線不能正常工作 | 與客戶服務部聯絡 |
| 2 | 蒸焗爐不能操作 | 電源插頭沒有插好 | 重新插好電源插頭 |
| | | 爐門沒有關好 | 重新關閉爐門 |
| | | 水箱沒有放置妥善 | 重新放回水箱並妥善安裝 |
| | | 電路板損壞 | 與客戶服務部聯絡 |
| | | 兒童安全鎖被鎖住 | 解除兒童安全鎖 |
| 3 | 顯示屏顯示異常 | 顯示屏損壞 | 與客戶服務部聯絡 |
| | | 電路板損壞 | |
| 4 | 烹調期間大量排水或蒸氣 | 爐門沒有關上 | 重新把爐門關上 |
| | | 爐門封邊損壞 | 與客戶服務部聯絡 |
| 5 | 爐燈不亮 | 爐燈損壞 | 與客戶服務部聯絡 |
| | | 主機電腦板損壞 | |
| 6 | 風扇不能正常運作 | 風扇電機損壞 | 與客戶服務部聯絡 |
| | | 主機電腦板損壞 | |
| 7 | 按鍵失靈 | 導電橡膠按鍵裝置錯誤或損壞 | 與客戶服務部聯絡 |
| | | 主機電腦板損壞 | |
| 8 | 無蒸氣噴出 | 水管被折疊、堵塞或損壞 | 與客戶服務部聯絡 |
| | | 水泵損壞 | |
| | | 水箱內無水或水箱沒有放置妥善 | |
| 9 | 蒸焗爐漏水 | 沒有把儲水箱完整推進到位 | 請將水箱加滿水並妥善安裝 |

其他須知

B. 下列情況均屬正常

| | 情況 | 原因 |
|---|-------------------------------|---|
| 1 | 首次使用各種燒烤或烤焗模式時，蒸焗爐有少量白煙冒出及異味。 | 這是由爐腔裡保護部件的過多油脂揮發所引起的。這屬於正常現象，非損壞。 |
| 2 | 使用蒸氣相關功能時有聲音 | 水箱吸水時或會混入空氣造成聲音，是正常現象。 |
| 3 | 蒸氣凝結在出風口或蒸氣從爐門四周縫隙處溢出 | 使用與蒸氣相關的功能時，蒸焗爐運轉過程中爐腔內會產生大量蒸氣，爐腔內多餘的蒸汽會通過出風口排出，但少部分蒸汽由於環境溫度，會凝結在出風口口處，或部分蒸氣可能從門縫四周漏出，這是正常現象。 |
| 4 | 烹調結束後風扇仍在工作 | 烹調結束後，風扇會延時工作 3 分鐘，將腔體內的熱量排出。這是產品冷卻爐腔和電子元件，屬於正常現象。 |
| 5 | 如發現有白色粉末在入氣口流出 | 這是水垢，是正常現象。如發現白色粉末（水垢），請啟動除垢模式，以清潔水管。 |
| 6 | 如爐腔 / 爐底有變黃現象 | 不銹鋼受熱後，如清潔處理不善，會產生變黃現象。建議每次使用蒸焗爐後，進行清潔以避免變黃現象產生。 |
| 7 | 電壓波動，烹調效果會受影響 | 當電壓在 - 10%至 + 5%的範圍波動時，蒸焗爐仍能工作，只是受電壓偏低或偏高的影響，輸出功率相對降低或升高，對烹調效果會有影響，這是正常現象。 |

其他須知

■ 產品規格

| | |
|------------------|--------------------|
| 型號 | W3MS450 |
| 額定電壓及額定頻率 | 220-240V~ 50/60Hz |
| 額定輸入功率 | 2200W |
| 產品尺寸 (高 × 闊 × 深) | 455 x 595 x 556 毫米 |
| 爐腔尺寸 (高 × 闊 × 深) | 265 x 484 x 430 毫米 |
| 爐腔容積 | 58L |
| 淨重 | 約 38 kg |

Table of Contents

| ■ General Preparation and Advice before Use | | Page |
|---|-------|-------|
| Important Safety Information | | 45 |
| Precautions before First Use | | 45 |
| Precautions and Advice | | 45 |
| Installation | | 46 |
| Appliance and Accessories Chart | | 47-48 |
| Control Panel | | 49 |
| Control Panel – Basic Functions | | 50 |
| Control Panel – Special Functions | | 51 |
| Control Panel – Major Features | | 51 |
| Control Panel – Description of Major Features | | 52-53 |
| Use and Cooking Tips | | 54 |

| ■ Operation Instructions | | Page |
|---|-------|-------|
| Setting the Clock | | 55 |
| Steam Mode | | 56 |
| Forced Air + Steam Mode | | 57 |
| Convection + Steam Mode | | 58 |
| Upper/ Bottom Grill/ Conventional Bake Mode | | 59-60 |
| Forced Air Mode | | 61 |
| Turbo Convection Mode | | 62 |
| Convection Mode | | 63 |
| Defrost Mode | | 64 |
| Drying Fruit Mode | | 65 |
| Preheat Mode | | 66-67 |
| Proving Mode | | 68 |
| Keep Warm Mode | | 69 |
| Descaling Mode | | 70-71 |
| Sterilization Mode | | 72 |
| Cavity Drying Mode | | 73 |
| DIY Cooking Mode | | 74-75 |
| Preset Function | | 76-77 |
| Adjust or Increase the Cooking Time during/after Cooking is Completed | | 78-79 |
| Residual Heat Indicator | | 80 |
| Child Lock | | 80 |

| ■ Cleaning and Maintenance | | Page |
|---|-------|------|
| Cleaning and Maintenance | | 81 |
| Shelf removal and installation | | 82 |
| Removal and installation of inner heat shield | | 83 |
| Removal and installation of water tank | | 83 |

| ■ Others | | Page |
|------------------------|-------|-------|
| Troubleshooting | | 84-85 |
| Product Specifications | | 86 |

General Preparation and Advice before Use

■ Important Safety Information

This manual contains important information on safety, use and maintenance of the product. Please read the manual carefully and keep it in an easily accessible place for future reference.

■ Precautions before First Use

1. Two or more people are required to install or move this appliance as it is heavy. It must be securely placed on a firm and level surface. Failure to do so can cause physical injuries or damage to the appliance.
2. This appliance is designed solely for indoor and domestic use. Follow the cooking instructions indicated in the manual. Do not use this appliance for outdoor, commercial or any other purposes.
3. Check that the voltage on the rating label corresponds to the voltage in your home.
4. Ensure that the appliance is not damaged. Do not operate the appliance if it has a damaged mains cord or plug. If it is not working properly, or it has been damaged or dropped. Please contact Whirlpool Customer Services.
5. Do not immerse the power cord or plug in water. Keep the power cord away from hot surfaces to avoid electrical shock, fire or other accidents.
6. To avoid damage to the appliance, do not block the ventilation vent.
7. Run the "Sterilization Mode" for 30 minutes to clean and sterilize the combi steamer before first use.
8. The manufacturer disclaims all liability for faults arising from improper use of this appliance.
9. Warm steam is emitted from the front ventilation vent. Blocking the outlets will result in damage to the combi steamer.
10. Use heat resistant utensils for cooking, such as heat resistant glass and heat resistant plastic. Non-heat resistant containers should not be used with combi steamer. For steaming functions, container with heat resistant >120°C should be used. For convection functions, container with heat resistant >250°C should be used.
11. Odour will be emitted from the cavity when using different baking functions for the first time. It is normal.
3. To avoid fire hazard or explosion, do not heat or use flammable materials in or near the appliance.
4. To avoid fire hazard, do not use the appliance to dry cloth, paper, spices, herbs, wood, flowers or other flammable objects.
5. Overcooking food poses a fire hazard.
6. Never leave the appliance unattended during use, particularly when cooking with paper, plastic or other flammable materials. Paper may catch fire or get burned and some plastic materials may melt when heating up food with the appliance. If any object inside or outside the appliance is ignited or emits smoke, close the appliance door and switch off the combi steamer. Disconnect the power supply and the socket with circuit leakage breaker.
7. This combi steamer is specifically designed to heat or cook food. It is not designed for industrial or laboratory used.
8. This combi steamer is not intended for use by persons (including children) with reduced physical, sensory or mental capabilities, or lack of experience and knowledge, unless under supervision or instruction of a person responsible for their safety.
9. After cooking, clean the combi steamer only when it has completely cooled down. Wipe away any food debris or waste inside the oven. Top of the oven cavity gets burned easily and care should be taken to keep it clean. For best cooking results, keep the combi steamer completely dry by opening the door every time after cooking.
10. Use oven gloves to take food and containers out of the appliance to avoid burning.
11. To avoid a hazard, do not touch the upper heater in the oven when using the appliance.
12. Do not use the combi steamer for storage.
13. After heating food or beverages in nursing bottles or infant food cans, always stir and check the temperature before serving. This will ensure that heat is evenly distributed and the risk of scalding or burns can be avoided.
14. Wait 10-15 minutes after each program before continuing to another mode.
15. Steam will be rapid evaporated and not easily be seen if the oven cavity at the high temperature or just finished all convection modes. It is normal.
16. Do not touch the door and door frame when using the appliance.
17. Fill the water tank with tap water, drinking water or distilled water up to the MAX mark (1200ml). Insert the water tank into the appliance completely until it clicks to ensure it is fixed in the right position.
18. If the water tank is cracked or damaged, stop using it to avoid power leakage or electrical shock caused by water leakage.

■ Precautions and Advice

1. Stop using the combi steamer and contact Whirlpool Customer Service immediately if the door or door seal is damaged.
2. If the power cord is damaged, it must be replaced by the manufacturer, its service agent or similarly qualified persons in order to avoid a hazard.

General Preparation and Advice before Use

19. For hygienic reasons and prevent condensation inside the combi steamer. Empty the water tank and keep the combi steamer completely dry every time after cooking.
20. Do not fill the water tank with any liquids other than water (except descaler).
21. To avoid condensation and oven temperature drops, do not open the oven door when cooking with "Steam" mode unless it is absolutely necessary. If you have opened the oven door, extend the cooking time accordingly.
22. If it is necessary to open the oven door to turn the food or for other purposes during cooking, keep a distance from the oven door (particularly the face) to prevent scalding.
23. All maintenance and repairs should be carried out by similarly qualified person. It is dangerous to fix the appliance by anyone except similarly qualified person. Never dismantle, repair or modify the appliance by yourself.
24. Accessible parts of the appliance may become hot during use. Young children should be kept away.
25. When combi steam is plugged, never touch the appliance, the power cord or plug with wet hands or other wet body parts. Do not use the appliance when you are barefoot.
26. Do not place or hang any objects on the oven door or the door handle. It may affect door's opening and closing or damage the door hinges.
27. After cooking ends, the electric fan will continue running for a certain period of time to cool down the cavity.
28. The combi steamer and its parts should be kept clean. Failure to do so will result in deterioration of the appliance surface and affect its life cycle. It may also cause danger.
29. Remove the power supply plug before cleaning. Do not use corrosive cleaners as they may cause damage or corrosion.
30. Water in the water tank will be heated up and discharged to the drip tray during "Descaling Mode". Do not allow children to touch or go near the combi steamer.
31. Remove the power supply plug before cleaning the cavity. If you need to clean the fan, remove the back panel of the oven carefully. Put it back in place as instructed after cleaning. (Please refer to "Removal and installation of inner heat shield" in this instruction manual)
32. Never leave the combi steamer in operation unattended.
33. Overheated fat and oil catch fire easily. Except grilling meat, heating oil during cooking is dangerous. Such practice should never be allowed.
34. To avoid damaging the combi steamer, do not place food or heavy objects on the oven door.
35. Exercise caution when the oven door is in the open or down position, to avoid hitting the door.
36. Do not use extension leads, multiple sockets or adapters. The electrical components must not be accessible to the user after installation.
37. CAUTION: The appliance is not intended to be operated by means of an external switching device, such as a timer, or separate remote controlled system.

38. Do not install the appliance behind a decorative door - risk of fire.
39. Keep clothes or other flammable materials away from the appliance, until all the components have cooled down completely - risk of fire. Always be vigilant when cooking foods rich in fat, oil or when adding alcoholic beverages - risk of fire.

■ Installation

Installation instructions are shown schematically and are for reference only. If there is any changes, please use the physical prevail, notice will not be given.

All dimensions stated in these installation instruction are in mm.

It must be possible to disconnect the appliance from the power supply by unplugging it if plug is accessible, or by a multi-pole switch installed upstream of the socket in accordance with the wiring rules and the appliance must be earthed in conformity with national electrical safety standards.

Install

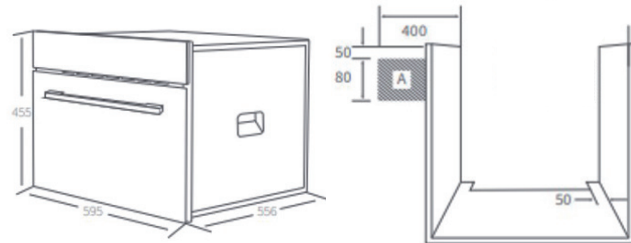

The main socket of this product is recommended to be installed in the side cabinet of the product, within the shaded area A.

Kitchen Cabinet

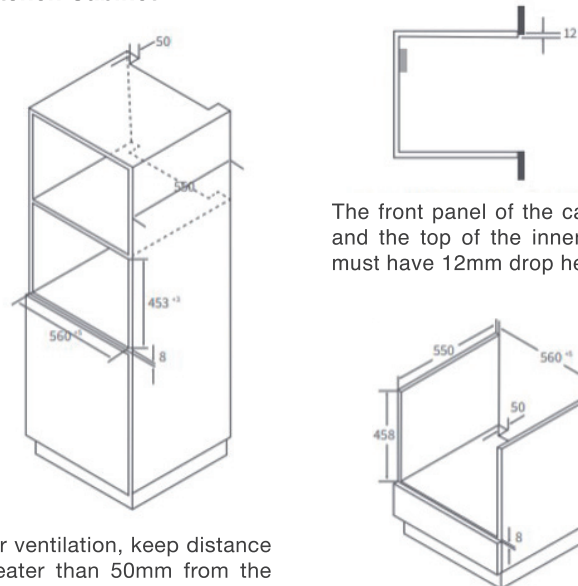

For ventilation, keep distance greater than 50mm from the back of the product.

The front panel of the cabinet and the top of the inner hole must have 12mm drop height.

Between the bottom of the product and the top of the lower cabinet, minimum 8mm space is needed.

General Preparation and Advice before Use

■ Appliance and Accessories Chart

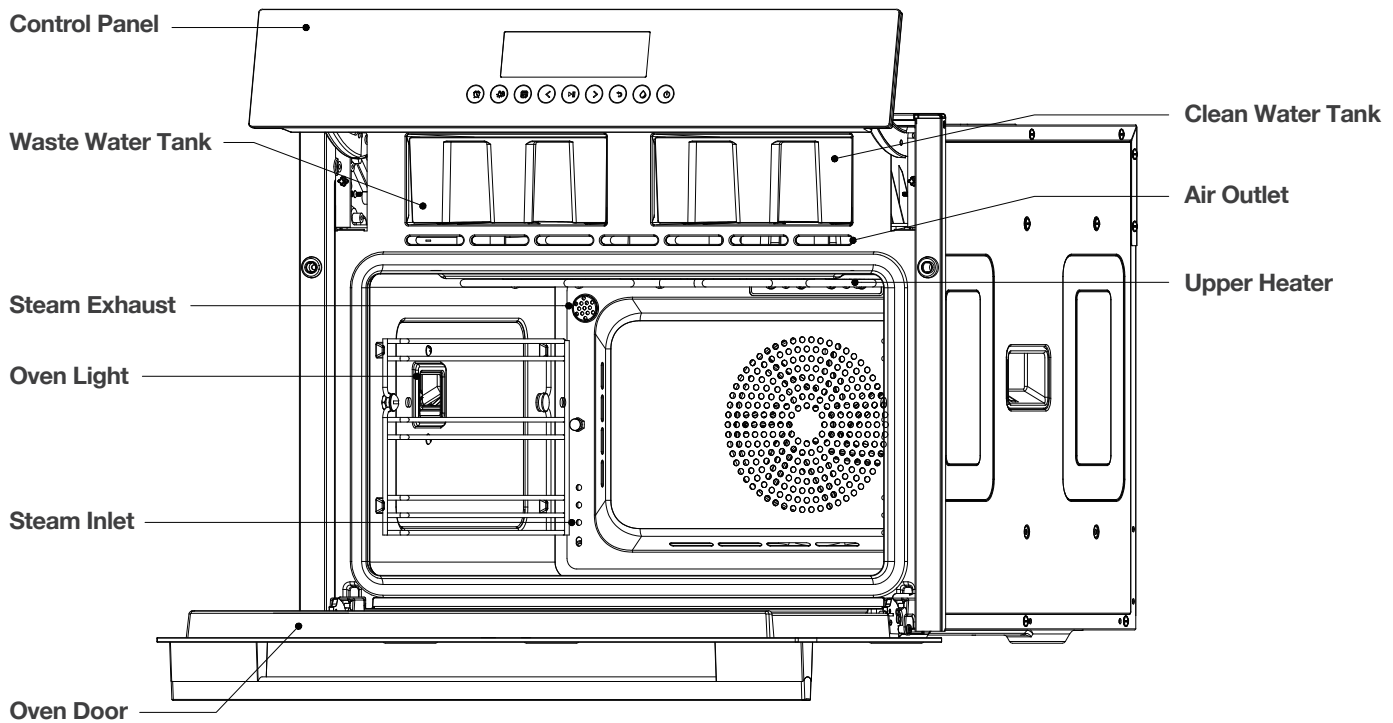

- 1. Control Panel:** To operate the combi steamer (For details see the control panel instructions)
- 2. Waste Water Tank:** Used to collect the waste water in the evaporation pan and pipeline after cooking and descaling.
- 3. Clean Water Tank:** Used to hold clean water to generate steam.
- 4. Air Outlet:** To exhaust excessive steam from the cavity.
- 5. Upper Heater:** To generate heat to cook food.
- 6. Air Inlet:** To discharge excess steam from the cavity to Air Outlet.
- 7. Oven Light:** To light up the oven to observe the food being cooked.
- 8. Steam Inlet:** To release steam into the cavity
- 9. Oven Door:**
 1. Make sure the door is closed before starting to cook.
 2. The combi steamer will pause if you open the oven door during cooking. The selected mode will continue automatically once the door is closed.

General Preparation and Advice before Use

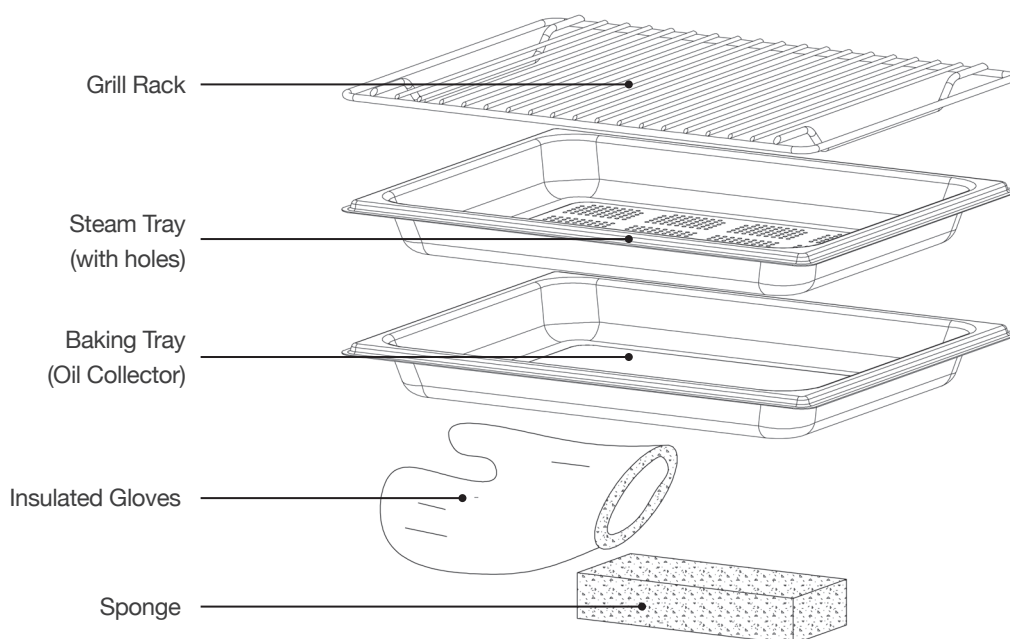

1. Grill Rack

- (A) Mainly for modes that cook with the heater, such as “Grill”, “Convection” or “Forced Air” mode.
- (B) For multi-layers cooking, it is recommended to place the grill rack on the lowest level for better air circulation and even oven temperature.
- (C) When grilling food without any container, please place baking paper or aluminum foil onto the grill rack before cooking.

2. Steam Tray (with holes)

- (A) Mainly for the “Steam” mode. Designed with vent holes, it can also be used for other cooking modes.
- (B) For multi-layer cooking, it is recommended to place the steam tray on a lower level to aid internal air circulation and even oven temperature. For 3 layers cooking, it is recommended to place steam tray on a middle level.

3. Baking Tray (oil collector)

- (A) Mainly for the “Forced Air + Steam”, “Convection + Steam” or “Forced Air” mode. It can also be placed at the bottom level to collect dripping oil when cooking meat.
- (B) When baking food without any container, please place baking paper or aluminum foil onto the baking tray.

4. Insulated gloves

To take food or rack out from the combi steamer.

5. Sponge

To remove condensation inside the oven.





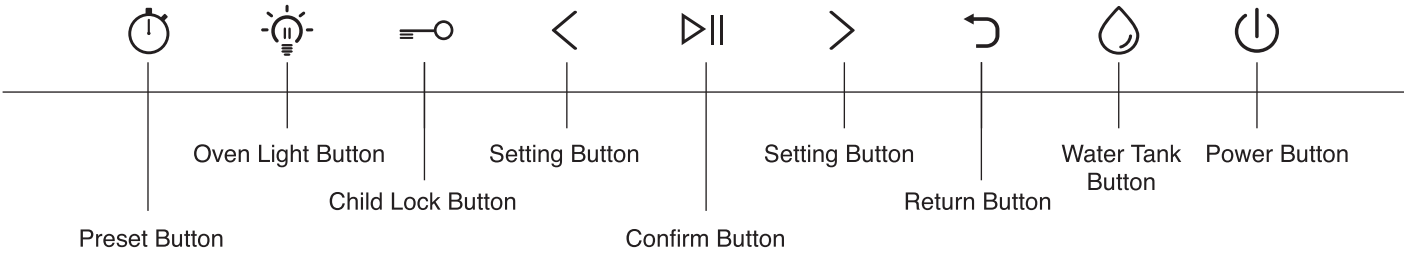
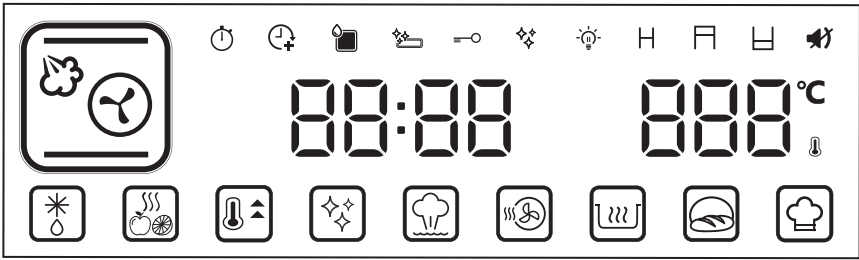

General Preparation and Advice before Use

■ Control Panel



General Preparation and Advice before Use

■ Control Panel – Basic Functions

| Icon | Function Descriptions |
|---|--|
|  | <p>Setting Button Function / Time / Temperature Settings</p> |
|  | <p>Confirm Button Confirm / Start / Pause Settings</p> |
|  | <p>Return Button</p> <ol style="list-style-type: none"> Return / Reset; Press the return button during setting to go back to the previous screen or reset cooking modes or cooking time. Mute Mode To activate mute mode: In standby mode, press and hold the button for 3 seconds to activate the mute mode. The mute icon lights up on the display panel. To release mute mode: In standby mode, press and hold the return button for 3 seconds while it is activated. |
|  | <p>Oven Light Button</p> <ol style="list-style-type: none"> Touch once to switch the light on for 3 minutes. The oven light icon will not light up on the display panel. Press and hold for 3 seconds, the oven light will stay on. The oven light icon will light up on the display panel. Press and hold for 3 seconds again to switch off the oven light. The oven light will light up for 3 minutes when the door is open. |
|  | <p>Child Lock Button</p> <p>Press and hold the button for 3 seconds to activate / release the child lock.</p> <p>To activate child lock: Press and hold the button for 3 seconds. The control panel will be locked and no operation is possible. The child lock icon lights up on the display panel.</p> <p>To release child lock: To release, press and hold the child lock button for 3 seconds while it is activated.</p> |
|  | <p>Power Button</p> <p>After 5 minutes without operation after activate the combi steamer, including opening or closing the oven door. Combi steamer will automatically enter to power-saving mode, display panel goes out. In power-saving mode, only power button is operable.</p> |

General Preparation and Advice before Use

Control Panel – Special Functions

| Combination Button | Icon | Function Descriptions |
|--|------|--|
| Combination Button: Cavity temperature display | | To change temperature display to actual oven temperature, press the 【Child Lock】 + 【Oven Light】 buttons simultaneously for 3 seconds during operation. |

Control Panel – Major Features

Clock and Time

Clock: Clock is displayed in standby: 24-hour clock

Display range: 00:00–23:59

Time: The duration of cooking time

Adjustable range: 00:05–12:59

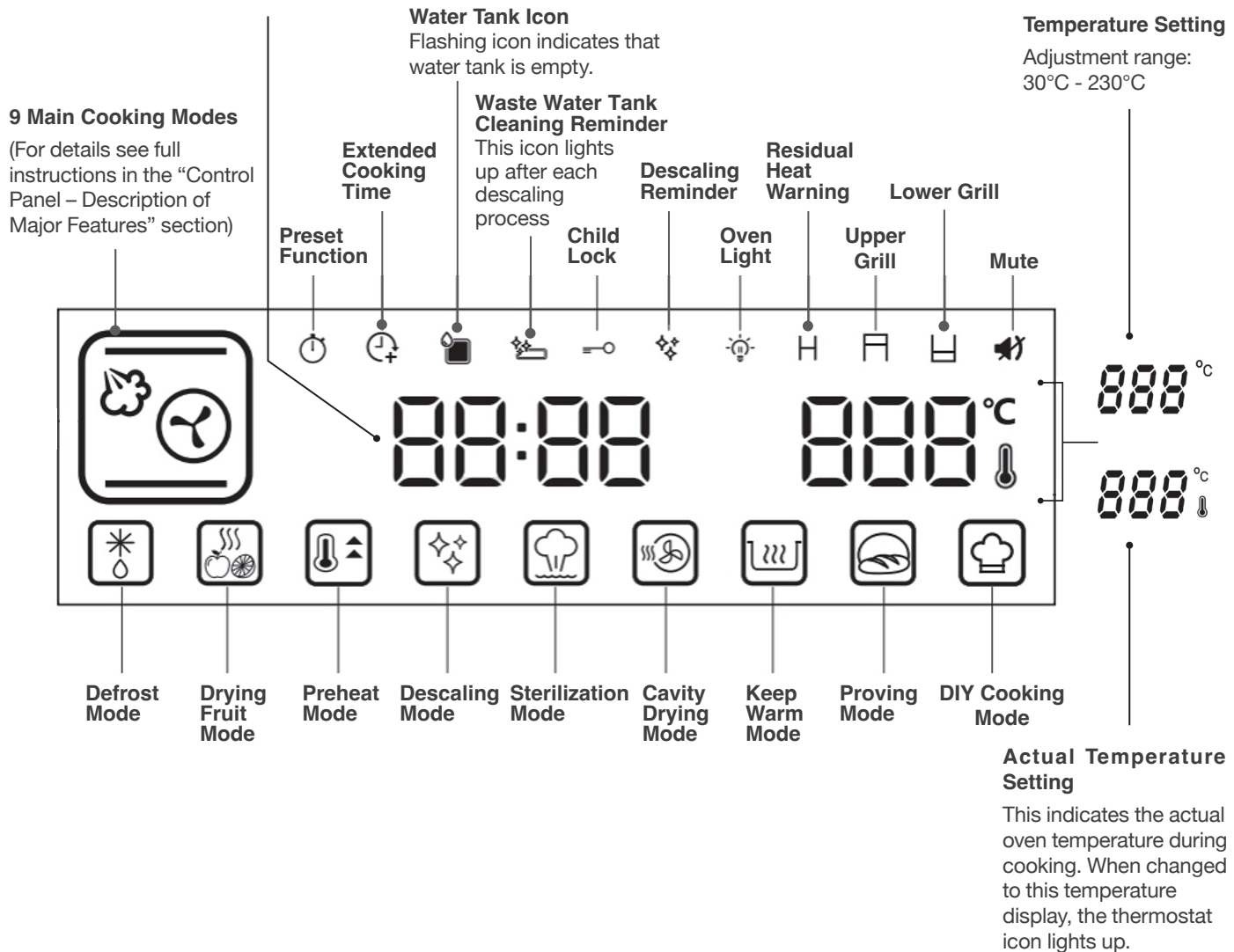









General Preparation and Advice before Use

■ Control Panel – Description of Major Features

| Icon | Mode | Function Descriptions | Default Time/ Temperature | Time/ Temperature Selection Range |
|------|--------------------|---|---------------------------|--|
| | Steam | Steam cooking preserves the original taste, nutrients and color of food cooked. It is suitable for steaming vegetables, meat and seafood or braising soup. | 20 minutes / 100°C | Time: 5-419 mins (maximum 6 hours 59 mins) Temperature: 50-110°C |
| | Forced Air + Steam | Cooking food with hot air and steam to prevent moisture loss during high baking temperature. The rear fan produces good circulation of hot air to ensure even heating on multiple levels. This mode is suitable for all types of food. | 30 minutes / 120°C | Time: 5-239 mins (maximum 3 hours 59 mins) Temperature: 80-200°C |
| | Convection + Steam | This mode combines upper, lower heat, hot air and steam cooking. It is a perfect all-in-one combination cooking. Adding steam during the cooking process can prevent moisture loss during high temperature cooking. Suitable for cooking all types of food, such as large cuts of meat or baking moist cakes. | 20 minutes / 180°C | Time: 5-239 mins (maximum 3 hours 59 mins) Temperature: 80-230°C |
| | Upper Grill | Suitable for roasting baking- food or at a final stage of roasting or baking. It helps browning the surface of your dish. | 25 minutes / 110°C | Time: 5-239 mins (maximum 3 hours 59 mins) Temperature: 50-230°C |
| | Bottom Grill | Suitable for baking the final stage or for food that needs to be cooked from the bottom periodically during cooking. e.g. pizzas, macaroon. | 20 minutes / 110°C | Time: 5-239 mins (maximum 3 hours 59 mins) Temperature: 50-230°C |
| | Conventional Bake | Traditional single-level baking and grilling mode. Heat is released from the top and bottom to get food baked evenly. Suitable for cooking meat, fish, bread and cookies, pastries and desserts etc., and particularly suitable for cakes with moist ingredients at the top. | 30 minutes / 180°C | Time: 5-239 mins (maximum 3 hours 59 mins) Temperature: 50-230°C |
| | Forced Air | The appliance comes with a rear fan which distributes the hot air produced by the rear heater evenly inside the oven. Food on different levels are heated evenly. It can be used in cooking multiple levels. | 20 minutes / 120°C | Time: 5-239 mins (maximum 3 hours 59 mins) Temperature: 50-230°C |
| | Turbo Convection | Cooking time is shortened in this mode to bake and roast food quickly. It is suitable for baking large meat and cakes. | 25 minutes / 180°C | Time: 5-239 mins (maximum 3 hours 59 mins) Temperature: 80-230°C |
| | Convection | The upper and bottom heater and rear fan operate simultaneously in this mode. Suitable for all baking dishes, such as meat, seafood, pizzas, bread and cookies, pastries and desserts. | 20 minutes / 160°C | Time: 5-239 mins (maximum 3 hours 59 mins) Temperature: 80-230°C |

General Preparation and Advice before Use

■ Control Panel – Description of Major Features

| Icon | Mode | Function Descriptions | Default Time/ Temperature | Time/ Temperature Selection Range |
|---|------------------|---|---------------------------|--|
|  | Defrost | Defrost chilled or frozen food. | 20 minutes / 50°C | Time: 5-239 mins (maximum 3 hours 59 mins) Temperature: 40-60°C |
|  | Drying Fruit | Food is dehydrated with hot air in low heat. Suitable for preparing dried fruit and sliced vegetable or meat jerkies. | 20 minutes / 80°C | Time: 5-779 mins (maximum 12 hours 59 mins) Temperature: 40-90°C |
|  | Preheat – Steam | Oven is heated to preset temperature by steam. | 100°C | Temperature: 50-110°C |
| | Preheat – Baking | Oven is heated to preset temperature by baking function. | 180°C | Temperature: 100-230°C |
|  | Descaling | Descaling icon will be on once combi steamer has reached 100 hours steam related cooking time to remind the user to run descaling programme mode. A descaler is required. | 50 minutes | Time: Cannot be adjusted Temperature: Cannot be adjusted |
|  | Sterilization | At sterilization mode, high temperature 120°C is used to sterilize dinnerware, cutlery or feeding bottles. | 20 minutes / 120°C | Time: 10-59 mins Temperature: 120°C |
|  | Cavity Drying | In this mode, the oven is heated to a high temperature so any excessive moisture and steam are evaporated. This function is used for drying the oven after any steam cooking modes. | 15 minutes / 180°C | Time: Cannot be adjusted Temperature: Cannot be adjusted |
|  | Keep Warm | Keeping food warm with hot air. Suitable for keeping cooked dishes warm. | 20 minutes / 40°C | Time: 5-779 mins (maximum 12 hours 59 mins) Temperature: 30-60°C |
|  | Proving | This mode works with steam to ensure stable and humidity inside the oven. It allows doughs (for pizzas or bread) to rise quicker in a stable environment, and it used for fermenting pizzas or bread. | 40 minutes / 35°C | Time: 10-779 mins (maximum 12 hours 59 mins) Temperature: 25-50°C |
|  | DIY Cooking | Complete a variety of different cooking function combination makes at one time automatically. | | |

General Preparation and Advice before Use

■ Use and Cooking Tips

1. Minimum time setting is 5 minutes for all cooking modes (Except the “Increase the Cooking Time after Cooking is Completed” function).
2. After cooking is done, the fan will continue to work for 3 minutes for cool down purpose. This is normal.
3. The combi steamer will pause automatically if you open the oven door during cooking. Cooking will continue automatically at the set time and temperature once the door is closed.
4. Take extra care when removing container from the oven after heating, like soup, sauce or beverage. To prevent over boiling, following steps should be taken in cooking liquid.
 - (a) Do not over-heat liquid food. Boiling liquid may splash out and cause scalding when you remove it from the combi steamer.
 - (b) When heating up liquid food, make sure the container is at most 80% full because a small amount of liquid may splash out suddenly when boiled.
 - (c) Stir the liquid before and during heating.
 - (d) Allow the food to stand inside the combi steamer for a while when heating is done. Stir it gently before removing.
 - (e) When using a feeding bottle or heating baby food, stir or shake the food and check the temperature before feeding to avoid burning.
5. Only use a thermometer designed for ovens to check food temperature during cooking, if necessary. If longer cooking time is required, put the food back into the combi steamer to continue cooking.
6. To avoid overheating or over-browning, it is recommended to take the food out when roasting or steaming is finished.
7. To maintain constant temperature during cooking, do not open the oven door unless it is necessary. To avoid affecting oven temperature, do not open the oven door to check food during cooking. If you have opened the oven door, extend the cooking time accordingly.
8. To ensure even browning and cooking, adjust or turn the food’s position or direction of the steam or grill plate halfway during heating.
9. Tray Placement Tips
 - For single layer cooking: It’s recommended to place a tray on the 2nd layer.
 - For two layers cooking: It’s recommended to place a tray on the 2nd and 1st layer.
 - For multi-layers cooking: It’s recommended to place a tray on the 1st, 2nd and 3rd layer.

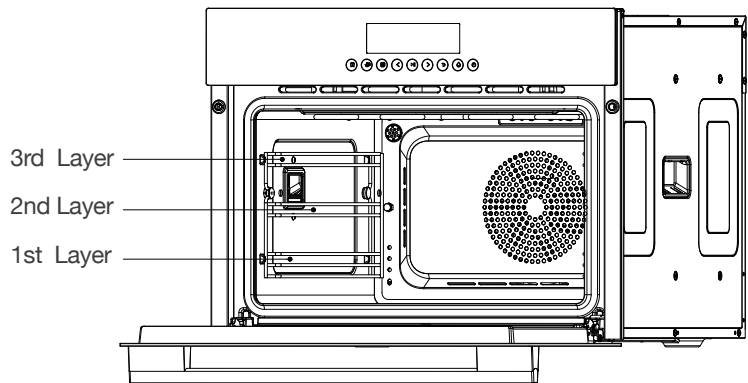

The suggested tray placement above is solely for reference. Tray placement is affected by the quantity, type and shape of food and containers.

Operation Instructions

■ Setting the Clock

When the appliance is first powered on, it will beep and returned to standby mode. The default clock display is 12:00. The display panel lights up completely.



12:00

The combi steamer returned to energy saving mode if no button is pressed or door is opened for 5 minutes. Under energy saving mode, display will be turned off, only the power button can be used. Press the power button to exit the energy saving mode and back to the startup screen.

Example: Set the clock to the current time 13:20.

Steps:

1. On the standby screen, press and hold the setting button (as shown in the diagram below)  for 3 seconds. The hour digits flash. (as shown in the diagram below)



12:00

2. Set the hour by turning the knob $< >$. When the hour reaches 13, press  to confirm.(as shown in the diagram below) The display will change to the minute setting automatically. The minute digits flash.



13:00

3. Set the minute by pressing $< >$. When the minute reaches 20, press  to confirm. (as shown in the diagram below)



13:20

4. Time setting is complete. (as shown in the diagram below)



13:20

Important: If no action is taken within 5 minutes during the setting process, all settings will be cancelled and the display will return to the standby screen. The combi steamer is in standby.

Operation Instructions



■ Steam Mode

Steam cooking preserves the original taste, nutrients and color of food. It is suitable for steaming vegetables, meat and seafood or braising soup. Always ensure the water tank is filled before using this mode.

| | Temperature | Time |
|-----------------|--------------|------------------------------|
| Default Setting | 100°C | 20 mins |
| Setting Range | 50°C - 110°C | 5 mins - 6 hours and 59 mins |

Example: Set the cooking time to 1 hour and 40 minutes; cooking temperature is 90°C.

Steps:

1. In standby mode, press > to  Steam Mode. The icon will flash. Press  to confirm (as shown in the diagram below). The display will jump to hour setting automatically.



2. Press < > until the hour display shows 01. Press  to confirm (as shown in the diagram below). The display will jump to minute setting automatically.



3. Press < > until the minute display shows 40. Press  to confirm (as shown in the diagram below). The display will jump to temperature setting automatically.

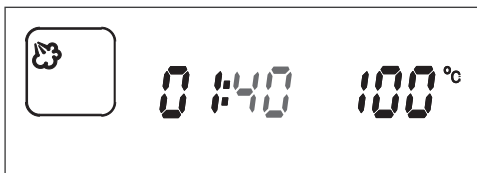

4. Press < > until the temperature display shows 90°C. Press  to confirm (as shown in the diagram below). The display



5. Setting is complete. The combi steamer will start cooking.

Operation Instructions

■ Forced Air + Steam Mode

Cooking food with hot air and steam to prevent moisture loss during high temperature cooking. The rear fan provides good circulation of hot air to ensure even heating on multiple levels. This mode is suitable for all types of food. It is recommended to place aluminum foil or baking paper onto the baking tray before cooking. Always ensure the water tank is filled before using this mode.

| | Temperature | Time |
|-----------------|--------------|------------------------------|
| Default Setting | 120°C | 30 mins |
| Setting Range | 80°C - 200°C | 5 mins - 3 hours and 59 mins |

Example: Set the cooking time to 40 minutes; cooking temperature is 210°C.

Steps:

1. In standby mode, press > to  Forced Air + Steam Mode. The icon will flash. Press  confirm (as shown in the diagram below). The display will jump to hour setting automatically.



2. Press  to confirm the 00 hour setting (as shown in the diagram below). The display will jump to minute setting automatically.

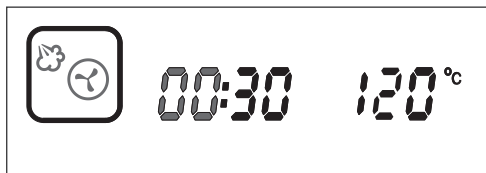

3. Press < > until the minute display shows 40. Press  to confirm (as shown in the diagram below). The display will jump to temperature setting automatically.



4. Press < > until the temperature display shows 210°C. Press  to confirm (as shown in the diagram below).



5. Setting is complete. The combi steamer will start cooking.

Operation Instructions

■ Convection + Steam Mode



This mode combines upper, lower heat, hot air and steam cooking. It is a perfect all-in-one combination cooking. Adding steam during the cooking process can prevent moisture loss during high temperature cooking. Suitable for cooking all types of food, such as large cuts of meat or baking moist cakes. It is recommended to place aluminum foil or baking paper onto the baking tray before cooking. Always ensure that the water tank is filled before using this mode.

| | Temperature | Time |
|-----------------|--------------|------------------------------|
| Default Setting | 120°C | 20 mins |
| Setting Range | 80°C - 200°C | 5 mins - 3 hours and 59 mins |

Example: Set the cooking time to 40 minutes; cooking temperature is 210°C.

Steps:

1. In standby mode, press > to  Convection + Steam Mode. The icon will flash. Press >| to confirm (as shown in the diagram below). The display will jump to hour setting automatically.



2. Press >| to confirm the 00 hour setting (as shown in the diagram below). The display will jump to minute setting automatically.



3. Press < > until the minute display shows 40. Press >| to confirm (as shown in the diagram below). The display will jump to temperature setting automatically.



4. Press < > until the temperature display shows 210°C. Press >| to confirm (as shown in the diagram below).



5. Setting is complete. The combi steamer will start cooking.

Operation Instructions

■ Upper/ Bottom Grill/ Conventional Bake Mode

Three grill modes are available: upper grill, bottom grill and conventional bake (upper and bottom grill). You can select a suitable mode according to the types of food and cooking result that you are looking for. It is recommended to place aluminum foil or baking paper onto the baking tray before cooking.

Upper Grill Mode: Suitable for roasting baking food or at a final stage of roasting or baking. It helps browning the surface of your dish.

Bottom Grill Mode: Suitable for baking in the final stage or for food that needs to be cooked from the bottom periodically during cooking, e.g. pizzas, macaroon.



Conventional Mode: Traditional single-level baking and grilling mode. Heat is released from the top and bottom to get food baked evenly. Suitable for cooking meat, fish, bread and cookies, pastries and desserts etc., and particularly suitable for cakes with moist ingredients at the top.

I) Upper Grill / Bottom Grill mode

| | Temperature | Time |
|-----------------|--------------|---|
| Default Setting | 180°C | 25 mins (Upper Grill Mode) / 20mins (Bottom Grill Mode) |
| Setting Range | 50°C - 230°C | 5 mins - 3 hours and 59 mins |

Example: Set the cooking time to 40 minutes; cooking temperature is 210°C.

Steps:

1. In standby mode, press > to  or  mode. Icon of the selected grill mode will flash. Press ▷| to confirm (as shown in the diagram below). The display will jump to hour setting automatically.

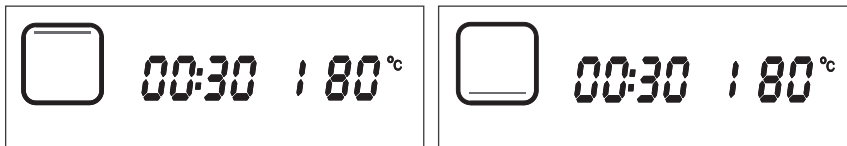

2. Press ▷| to confirm the 00 hour setting (as shown in the diagram below). The display will jump to minute setting automatically.

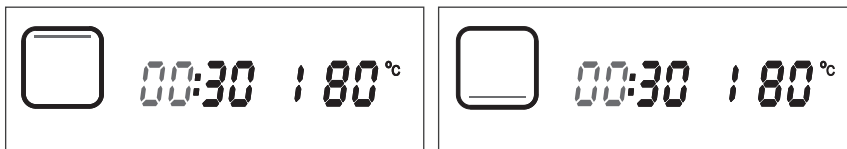

3. Press < > until the minute display shows 40. Press ▷| to confirm (as shown in the diagram below). The display will jump to temperature setting automatically.

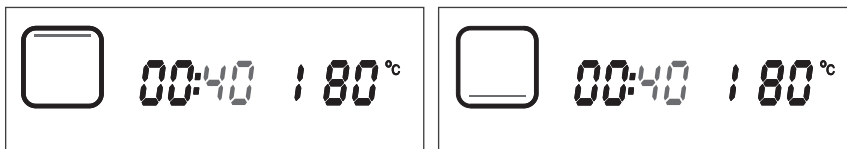

4. Press < > until the temperature display shows 210°C. Press ▷| to confirm (as shown in the diagram below).

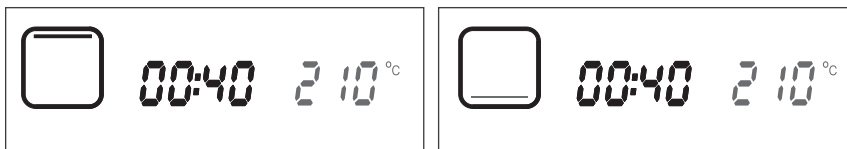

5. Setting is complete. The combi steamer will start cooking.

Operation Instructions

II) Conventional Bake Mode

| | Temperature | Time |
|-----------------|--------------|------------------------------|
| Default Setting | 180°C | 30 mins |
| Setting Range | 50°C - 230°C | 5 mins - 3 hours and 59 mins |

Example: Set the cooking time to 40 minutes; upper grill temperature is 210°C, bottom grill temperature is 180°C.

1. In standby mode, press > to  Conventional Bake mode. The icon will flash. Press ▷| to confirm the function. (As shown in the diagram below). The display will jump to hour setting automatically.



2. Press ▷| to confirm the 00 hour setting (as shown in the diagram below). The display will jump to minute setting automatically.



3. Press < > until the minute display shows 40. Press ▷| to confirm (as shown in the diagram below). The display will jump to temperature setting automatically.



4. Press < > until the temperature display shows 210°C. Press ▷| to confirm the upper grill temperature. (as shown in the diagram below).



5. Press < > until the temperature display shows 180°C. Press ▷| to confirm the bottom grill temperature. (as shown in the diagram below).

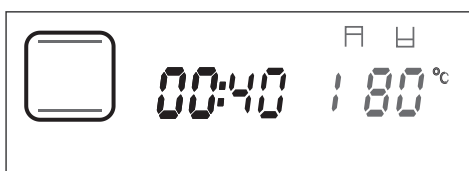

6. Setting is complete. The combi steamer will start cooking.

Operation Instructions

■ Forced Air Mode

The appliance comes with a rear fan which distributes the hot air produced by the rear heater evenly inside the oven. Foods on different levels are heated evenly. It can be used in cooking multiple levels. It is recommended to place aluminum foil or baking paper onto the baking tray before cooking.

| | Temperature | Time |
|-----------------|--------------|------------------------------|
| Default Setting | 120°C | 20 mins |
| Setting Range | 50°C - 230°C | 5 mins - 3 hours and 59 mins |

Example: Set the cooking time to 40 minutes; cooking temperature is 210°C.

Steps:

1. In standby mode, press > to  Forced Air Mode. The icon will flash. Press ▷| to confirm (as shown in the diagram below). The display will jump to hour setting automatically.



2. Press ▷| to confirm the 00 hour setting (as shown in the diagram below). The display will jump to minute setting automatically.



3. Press < > until the minute display shows 40. Press ▷| to confirm (as shown in the diagram below). The display will jump to temperature setting automatically.



4. Press < > until the temperature display shows 210°C. Press ▷| to confirm (as shown in the diagram below).



5. Setting is complete. The combi steamer will start cooking.

Operation Instructions

■ Turbo Convection Mode



Cooking time is shortened in this mode to bake and roast food quickly. It is suitable for baking large meat and cakes. It is recommended to place aluminum foil or baking paper onto the baking tray before cooking.

| | Temperature | Time |
|-----------------|--------------|------------------------------|
| Default Setting | 180°C | 25 mins |
| Setting Range | 80°C - 230°C | 5 mins - 3 hours and 59 mins |

Example: Set the cooking time to 40 minutes; cooking temperature is 210°C.

Steps:

1. In standby mode, press > to  Turbo Convection Mode. The icon will flash. Press > to confirm (as shown in the diagram below). The display will jump to hour setting automatically.



2. Press > to confirm the 00 hour setting. (as shown in the diagram below). The display will jump to minute setting automatically.



3. Press < > until the minute display shows 40. Press > to confirm (as shown in the diagram below). The display will jump to temperature setting automatically.



4. Press < > until the temperature display shows 210°C. Press > to confirm (as shown in the diagram below).



5. Setting is complete. The combi steamer will start cooking.

Operation Instructions

■ Convection Mode



The upper and lower heaters and rear fan operate simultaneously in this mode. Suitable for all baking dishes, such as meat, seafood, pizzas, bread and cookies, pastries and desserts. It is recommended to place aluminum foil or baking paper onto the baking tray before cooking.

| | Temperature | Time |
|-----------------|--------------|------------------------------|
| Default Setting | 160°C | 20 mins |
| Setting Range | 80°C - 230°C | 5 mins - 3 hours and 59 mins |

Example: Set the cooking time to 40 minutes; cooking temperature is Upper Grill 210°C; Bottom Grill 180°C.

Steps:

1. In standby mode, press > to  Convection Mode. The icon will flash. Press >| to confirm (as shown in the diagram below). The display will jump to hour setting automatically.



2. Press >| to confirm the 00 hour setting (as shown in the diagram below). The display will jump to minute setting automatically.



3. Press < > until the minute display shows 40. Press >| confirm (as shown in the diagram below). The display will jump to temperature setting automatically.



4. Press < > until the upper temperature display shows 210°C. Press >| confirm (as shown in the diagram below).



5. Press < > until the bottom temperature display shows 180°C. Press >| confirm (as shown in the diagram below).



6. Setting is complete. The combi steamer will start cooking.

Operation Instructions

■ Defrost Mode



Defrost chilled or frozen food with steam. Always ensure that the water tank is filled before using this mode.

| | Temperature | Time |
|-----------------|-------------|------------------------------|
| Default Setting | 50°C | 20 mins |
| Setting Range | 40°C - 60°C | 5 mins - 3 hours and 59 mins |

Example: Set the cooking time to 1 hour and 40 minutes; defrosting temperature is 60°C.

Steps:

1. In standby mode, press < to  Defrost Mode. The icon will flash. Press > to confirm (as shown in the diagram below). The display will jump to hour setting automatically.



2. Press < > until the hour display shows 01. Press > to confirm (as shown in the diagram below). The display will jump to minute setting automatically.



3. Press < > until the minute display shows 40. Press > to confirm (as shown in the diagram below). The display will jump to temperature setting automatically.



4. Press < > until the temperature display shows 60°C. Press > to confirm (as shown in the diagram below).



5. Setting is complete. The combi steamer will start cooking (as shown in the diagram below).



Operation Instructions

■ Drying Fruit Mode

Food is dehydrated with hot air in low heat. Suitable for preparing dried fruit and vegetable slices or meat jerkies.

| | Temperature | Time |
|-----------------|-------------|-------------------------------|
| Default Setting | 80°C | 20 mins |
| Setting Range | 40°C - 90°C | 5 mins - 12 hours and 59 mins |

Example: Set the cooking time to 2 hours; cooking temperature is 90°C.

Steps:

1. In standby mode, press < to  Drying Fruit Mode. The icon will flash. Press > to confirm (as shown in the diagram below). The display will jump to hour setting automatically.



2. Press < > until the hour display shows 02. Press > to confirm (as shown in the diagram below). The display will jump to minute setting automatically.



3. Press > to confirm the 00 minute setting (as shown in the diagram below). The display will jump to temperature setting automatically.



4. Press < > until the temperature display shows 90°C. Press > to confirm (as shown in the diagram below).



5. Setting is complete. The combi steamer will start cooking (as shown in the diagram below).



Operation Instructions

■ Preheat Mode

The Preheat Mode can be operated with steam or baking mode. The oven will be heated to preset temperature.

| | Steam Preheating | Baking Preheating |
|-----------------|------------------|-------------------|
| | Temperature | Temperature |
| Default Setting | 100°C | 180°C |
| Setting Range | 50°C - 110°C | 100°C - 230°C |

Oven will automatically adjust the cooking time according to set temperature. An audio tone will be heard when the temperature reaches the preset temperature. Current time is displayed during preheating. Always ensure that the water tank is filled before using steam preheating.

I) Steam preheat mode

Example: Set the steam preheating temperature to 100°C.

Steps:

1. In standby mode, press < to  Preheat Mode. The icon will flash. 01 is for steam preheat. Press > to confirm (as shown in the diagram below).

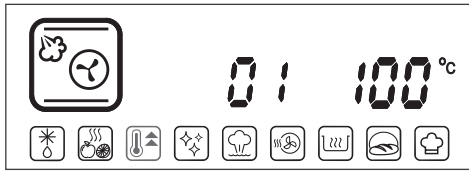

2. The display will jump to temperature setting automatically. Press > to confirm the default temperature 100°C (as shown in the diagram below).



3. Setting is complete. The combi steamer will start preheating (as shown in diagram below).



Operation Instructions

II) Baking preheat mode

Example: Set the baking preheating temperature to 200°C.

Steps:

1. In standby mode, press < to Preheating Mode . The icon will flash. 02 is for baking preheat, press > to confirm (as shown in the diagram below).



2. The display will jump to temperature setting automatically. Press < > until the display shows 200°C. Press > to confirm (as shown in the diagram below).



3. Setting is complete. The combi steamer will start preheating (as shown in the diagram below).



When preheating is complete, an audio tone will be heard. After preheating the combi steamer, you can select other cooking modes to continue your cooking as required.

Important: The function of “Adjust or Increase the Cooking Time during/after Cooking is Completed” is not available in this mode.

Operation Instructions

■ Proving Mode



This mode works with steam to ensure stable high temperature and humidity inside the oven. It allows dough (for pizza or bread) to rise quicker in a stable environment, and is used for fermenting dough for pizzas or bread. Always ensure that the water tank is filled before using this mode.

| | Temperature | Time |
|-----------------|-------------|--------------------------------|
| Default Setting | 35°C | 40 mins |
| Setting Range | 25°C - 50°C | 10 mins - 12 hours and 59 mins |

Example: Set the cooking time to 50 minutes; cooking temperature is 35°C.

Steps:

1. In standby mode, press < to  Proving Mode. The icon will flash. Press > to confirm (as shown in the diagram below). The display will jump to hour setting automatically.



2. Press > to confirm the 00 hour setting (as shown in the diagram below). The display will jump to minute setting automatically.



3. Press < > until the minute display shows 50. Press > to confirm (as shown in the diagram below). The display will jump to temperature setting automatically.



4. Press > to confirm the 35°C temperature setting (as shown in the diagram below).



5. Setting is complete. The combi steamer will start cooking (as shown in the diagram below).



Operation Instructions

■ Keep Warm Mode

Keeping food warm with hot air. Suitable for keeping cooked dishes warm.

| | Temperature | Time |
|-----------------|-------------|-------------------------------|
| Default Setting | 40°C | 20 mins |
| Setting Range | 30°C - 60°C | 5 mins - 12 hours and 59 mins |

Example: Set the cooking time to 1 hours and 30 minutes; cooking temperature is 60°C.

Steps:

1. In standby mode, press < to  Keep Warm Mode. The icon will flash. Press > to confirm (as shown in the diagram below). The display will jump to hour setting automatically.



2. Press < > until the hour display shows 01. Press > to confirm (as shown in the diagram below). The display will jump to minute setting automatically.



3. Press > to confirm the "30" minute setting (as shown in the diagram below). The display will jump to temperature setting automatically.



4. Press < > until the temperature display shows 60°C. Press > to confirm (as shown in the diagram below).



5. Setting is complete. The combi steamer will start cooking (as shown in the diagram below).





Operation Instructions

■ Descaling Mode



Water used in steaming mode may result in scale accumulated inside cavity and water pipe.

“Descaling” icon  will be on once combi steamer has reached 100hrs steam related cooking time to remind the user to run the descaling programme mode. The light will stay on until the descaling is performed.

Descaling is carried out in two stages that involve one descaling process and one cleaning process. The user has to change the liquid in the tank 2 times during the entire cleaning process. It is also necessary to empty the waste water tank by cleaning up. Icon  will be lighted to remind cleaning up the waste water tank is needed.

Also, descaler is required for this mode. Customer can select the Wpro descaler under Whirlpool brand. This product can be used in steamer for cleaning limescale deposits effectively, optimizing machine performance and prolonging the lifespan of the appliance. For more details, please visit our website which can be found on the cover page of this user manual.

For satisfactory results, follow the suggested dosage for descaler and water below:



Stage 1: Descaling. Running time is 40 minutes. Suggested dosage: 30ml descaling agent and 300ml pure water.

Stage 2: Cleaning process. Running time is 10 minutes. Suggested dosage: 300ml pure water.

| | Temperature | Time |
|-----------------|--------------------|--------------------|
| Default Setting | Cannot be adjusted | 50 mins |
| Setting Range | Cannot be adjusted | Cannot be adjusted |

Steps:

1. Stage 1: Descaling

- A. Fill the water tank with 30ml descaling agent and 300ml pure water.
- B. In standby mode, press < > to  Descaling Mode. The icon will flash. Press  to confirm (as shown in the diagram below).



- C. The descaling mode will start (as shown in the diagram below).



- D. Stage 1 takes 40 minutes. When done, the time display digits will flash and an audio tone will sound to indicate stage 1 is complete.  waste water tank cleaning reminder icon will light up on the display panel to remind the user to empty the waste water tank.
- E. Pour out the dirty liquid and put the waste water tank back into place.

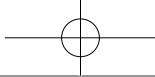

Operation Instructions

2. Stage 2: cleaning process

- A. Open the oven door, fill the water tank with 300ml pure water.
- B. Put the water tank back into place and close the oven door. Cleaning will begin automatically.
- C. When done, the time display digits will flash and an audio tone will sound to indicate stage 2 is complete. waste water tank  cleaning reminder icon will light up on the display panel to remind the user to empty the waste water tank.
- D. Pour out the dirty liquid and put the waste water tank back into place.

3. Descaling process completed.

Operation Instructions

■ Sterilization Mode

At sterilizing mode, high temperature 110°C is used to sterilize dinnerware, cutlery or feeding bottles. Always ensure that the water tank is filled before using this mode.

| | Temperature | Time |
|-----------------|--------------------|-------------------|
| Default Setting | 120°C | 20 mins |
| Setting Range | Cannot be adjusted | 10 mins - 59 mins |

Example: Set the cooking time to 35 minutes.

Steps:

1. In standby mode, press < > to  Sterilization Mode. The icon will flash. Press \triangleright to confirm (as shown in the diagram below). The display will jump to hour setting automatically.



2. Press \triangleright to confirm the 00 hour setting (as shown in the diagram below). The display will jump to minute setting automatically.



3. Press < > until the minute display show 35. Press \triangleright to confirm (as shown in the diagram below).

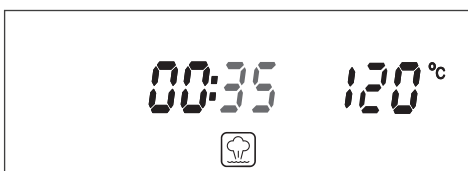

4. Setting is complete. The combi steamer will start cooking (as shown in the diagram below).



Operation Instructions

■ Cavity Drying Mode

In this mode, the oven is heated to a high temperature so any excessive moisture and steam are evaporated. This function is used for drying the oven after any steam cooking modes.

| | Temperature | Time |
|-----------------|--------------------|--------------------|
| Default Setting | 180°C | 15 mins |
| Setting Range | Cannot be adjusted | Cannot be adjusted |

Steps:

1. In standby mode, press < to  Cavity Drying Mode. The icon will flash. Press > to confirm (as shown in the diagram below).



2. The combi steamer will start cooking (as shown in the diagram below).



Important:

1. The function of “Combination Button: Cavity temperature display” is not available in this mode.
2. The function of “Adjust or Increase the Cooking Time during/after Cooking is Completed” is not available in this mode.

Operation Instructions

■ DIY Cooking Mode

It is used to complete a variety of different cooking function combination at one time automatically, make cooking more diverse and convenient.

For example: first cook with Forced Air + Steam at 180°C for 10 minutes, then cook with Pure Steam at 100°C for 10 minutes, and then cook for 20 minutes at 180°C on Forced Air mode.

Steps:

1. In standby mode, press < to  DIY Cooking mode. The icon will flash. Press > to confirm the function. (As shown in the diagram below). The display will jump to cooking mode setting automatically.



2. Press > to  Forced Air + Steam mode. The icon will flash. Press > to confirm cooking mode (as shown in the diagram below). The display will jump to hour setting automatically.

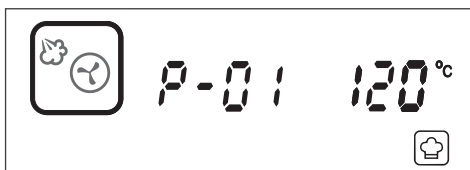

3. Press > to confirm the 00 hour setting (as shown in the diagram below). The display will jump to minute setting automatically.



4. Press < > until the minute display shows 10. Press > to confirm (as shown in the diagram below). The display will jump to temperature setting automatically.



5. Press < > until the temperature display shows 180°C. Press  to confirm the 1st cooking function setting and jump to next cooking function setup. (as shown in the diagram below).



6. Press > to  Pure Steam mode. The icon will flash. Press > to confirm cooking mode (as shown in the diagram below). The display will jump to hour setting automatically.

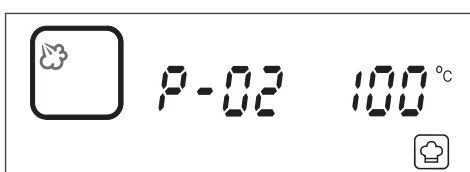

Operation Instructions

7. Press \triangleright to confirm the 00 hour setting (as shown in the diagram below). The display will jump to minute setting automatically.



8. Press \langle \rangle until the minute display shows 10. Press \triangleright to confirm (as shown in the diagram below). The display will jump to temperature setting automatically.



9. Press \langle \rangle until the temperature display shows 100°C. Press ⌚ to confirm the 2nd cooking function setting and jump to next cooking function setup. (as shown in the diagram below).



10. Press \triangleright to ⌚ Forced Air mode. The icon will flash. Press \triangleright to confirm cooking mode (as shown in the diagram below). The display will jump to hour setting automatically.



11. Press \triangleright to confirm the 00 hour setting (as shown in the diagram below). The display will jump to minute setting automatically.



12. Press \langle \rangle until the minute display shows 20. Press \triangleright to confirm (as shown in the diagram below). The display will jump to temperature setting automatically.



13. Press \langle \rangle until the temperature display shows 180°C. Press \triangleright to confirm the 3rd cooking function.



14. Setting is complete. The combi steamer will start cooking.



Operation Instructions

■ Preset Function

You must set the clock before using the preset function. For instructions on clock setting, please see “Setting the Clock” on page 55 of this instruction manual.

Example: The current time is 16:30. You want to preset cooking time for the Bottom Grill Mode. Cooking time is 40 minutes and temperature is 210°C. Cooking will stop at 18:00.

Steps:

1. In standby mode, press > to  Bottom Grill Mode. The icon will flash. Press  to confirm (as shown in the diagram below). The display will jump to hour setting automatically.



2. Press  to confirm the 00 hour setting (as shown in the diagram below). The display will jump to minute setting automatically.



3. Press < > until the minute display shows 40. Press  to confirm (as shown in the diagram below). The display will jump to temperature setting automatically.



4. Press < > until the temperature display shows 210°C. Press the clock button  to confirm (as shown in the diagram below).



5. The screen for presetting the finishing time will be seen. The clock will go back to current time display, i.e. 16:30. The “16” digits will flash. The  preset function icon at the top of the display panel will also flash to indicate preset setting is in process (as shown in the diagram below).





Operation Instructions

6. Press < > until the hour display shows 18. Press  to confirm (as shown in the diagram below). The display will jump to minute setting automatically

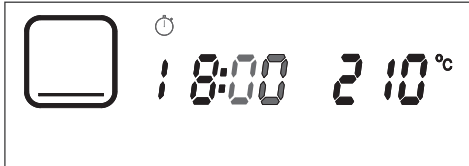

7. Press < > until the minute display shows 00. Press  to confirm.



8. The  preset function icon of the display panel will flash. Display will change from operating time back to the current time 15:50, indicating preset setting is complete (as shown in the diagram below).



* Oven light will turn off automatically after 3 minutes.

Cancelling Preset Function:

To cancel any preset function setting, press the  power button directly. The combi steamer will return to the standby screen automatically.

Important: Preset Function is available in 9 Main Cooking Modes, (See “Control Panel – Major Features / Description of Major Features on P.51-53 for details)

Suggestion: Preset cooking operation may be cancelled if children touch the screen accidentally. To avoid this, activate the child lock function after setting the preset function. For instructions on setting the child lock, please see “Control Panel – Basic Functions” on page 50 of this instruction manual. The child lock will not affect cooking. The combi steamer will start cooking normally at the preset time.

Operation Instructions

■ Adjust or Increase the Cooking Time during/after Cooking is Completed

A. Adjust the cooking time during cooking process

You can extend or shorten the cooking time and the temperature as required during the cooking process.

Example: Change the cooking time and temperature settings from 01:40 and 90°C to 02:00 and 100°C.

Steps:

1. During cooking, press  to interrupt and pause the cooking. The time display will flash (as shown in the diagram below).



2. Press < > until the hour display shows 02 (as shown in the diagram below). Press the return button  to confirm. The display will jump to temperature setting automatically.



3. Press < > until the temperature display shows 100°C (as shown in the diagram below). Press the return button  to confirm. The display will jump to minute setting automatically.



4. Press < > until the minute display shows 00. Press  to confirm (as shown in the diagram below).



5. Setting is complete. Cooking will be resumed with new settings (as shown in the diagram below).



Operation Instructions

B. Increase the cooking time after cooking is completed

You can increase the cooking time after cooking is completed. Temperature cannot be adjusted.

| | Temperature | Time |
|---------------|--------------------|-------------|
| Setting Range | Cannot be adjusted | 1 – 59 mins |

When cooking is completed, the “END” will be shown on display and an audio tone sounds. The  “Extended Cooking Time” icon will light up on the display.

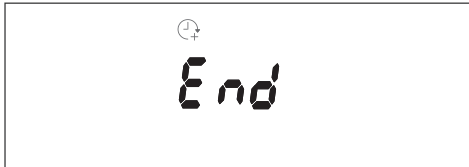

To increase the cooking time, follow the steps below:

Example: Cooking is completed and need to increase the cooking time by 3 minutes, cooking temperature is 90°C.

Steps:

1. Press  to confirm to increase the cooking time, the display will jump to minute setting automatically.



2. Press   until the minute display shows 03. Press  to confirm (as shown in the diagram below).



3. The display will jump to temperature setting automatically. Press  to confirm (as shown in the diagram below).



4. Setting is complete. Cooking will resume with added cooking time under previous settings (as shown in the diagram below).



Note: If no action is taken within 3 minutes after cooking is completed, the combi steamer will return to standby mode.

Operation Instructions

■ Residual Heat Indicator

In standby or energy-saving mode the  “Residual Heat Indicator” icon will be shown to warn that cavity exceed 50°C and is not suitable for cleaning (as shown in the diagram below). The icon will be off until cavity drop below 50°C. Users should not clean the appliance until the icon is off.



■ Child Lock

Steamer is equipped with child lock so that children cannot switch on or change any setting accidentally.

A. Activating the Child Lock:

Press and hold the  “Child Lock” button for 3 seconds. Child lock is enabled. The “Child Lock” icon lights up (as shown in the diagram below).



B. Cancelling the Child Lock:

Press and hold the  “Child Lock” button for 3 seconds to disable the child lock function. The “Child Lock” icon goes off.

Cleaning and Maintenance

■ Cleaning and Maintenance

1. Under normal circumstances, cleaning is the only maintenance required.
2. Cleaning and maintenance should only be carried out when the combi steamer is cool and the Residual Heat Indicator icon disappeared. Disconnect the power plug from the main power supply before cleaning. Do not use any steam cleaner to clean this appliance.
3. To avoid corrosion which would shorten the useful life of your combi steamer, always keep it clean. Always clean the appliance after use.
4. To avoid damage to the combi steamer body, control panel, oven walls and accessories, do not use any cleaning cloth that contains metal, scrubbing cleaners, steel brush or cloth with a rough surface for cleaning. Use a sponge or cloth soaked in gentle detergent or kitchen towel paper sprayed with glass cleaner to clean the appliance. Always make sure the cavity (including the bottom) is completely dried after use.
5. Salt is a corrosive substance that would result in rust stains if left to build up inside the oven. Acidic sauces, such as ketchup, mustard and preserves, contain chemicals like chlorine and acids which would damage the stainless steel surface.
6. Do not allow grease and food debris to remain on the oven door and door seal. If the door seal is not kept clean, the oven door may fail to close when the appliance is in operation. This would cause damage to the front and sides of the combi steamer.
7. After each use:
 - i) Empty the black drip tray under the oven door to prevent overflow, splash and soiling of the worktop. (The drip tray can be removed. It collects condensation water every time after use when door is opened)
 - ii) Empty the water tank.
 - iii) Always leave the door opened for 15-30 minutes or run the Cavity Drying Mode to dry the oven and door frame.
8. If the oven is very dirty, run the Sterilization Mode (120°C) to remove grease and dirt with steam for 30 minutes before cleaning. Do not start cleaning until the appliance has cooled down. For stubborn grease stains, repeat these steps several times. Never use any cleaning cloth that contains metal, scrubbing cleaners, steel brush or cloth with a rough surface for cleaning.
9. It is suggested to run the Descaling Mode at least once a month or when the descaling icon lights up.
10. Tap water, drinking water or distilled water is suggested for steaming function. Avoid using mineral water.
11. The water tank must be checked at least once a month. Clean it if necessary and put it back correctly.
12. Disconnect the main power if the appliance will not be used for a long period. Keep the oven clean and put the appliance in a dry place away from corrosive gases.
13. After every use, clean and air dry the oven (including the top, sides and bottom). If discoloration is detected at the bottom or inside the oven, remove the stains with a stainless steel cleaner (e.g. Wpro Steel Cleaner).

Cleaning and Maintenance

■ Shelf removal and installation

1. Unscrew the screw clockwise on the front end of the rail

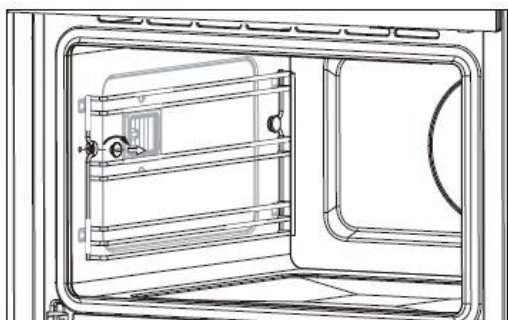

Note: Be sure to pay attention to the direction of rotation when removing the front screw. Incorrect disassembly can lead to locking of the front screw connection and cause damage to the structure, that the front-end screws will be unable to be disassembled normally.

2. Pull the shelf rails to the inside of the oven cavity and take them off at the front

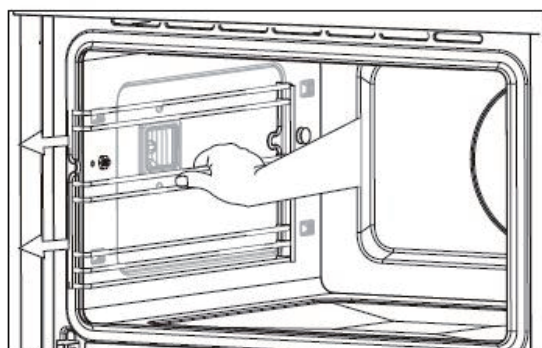
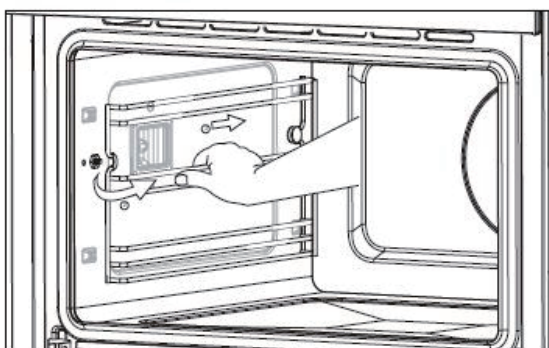

3. To install the shelf firmly, insert it into the screw at the rear end, and then tighten the screw at the front end anti-clockwise.

Cleaning and Maintenance

■ Removal and installation of inner heat shield

1. Use a suitable sleeve to cover the screw fixing the inner heat shield, turn it anti-clockwise until the screw can be removed and the inner heat shield can be taken out

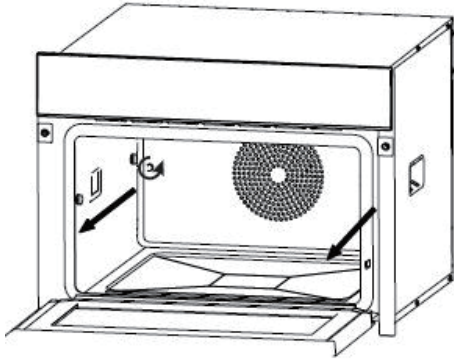

2. Put the inner heat shield horizontally into the cavity, place it on the corresponding screw on the rear plate of the cavity and tighten it clockwise with 2 screws to ensure firmness

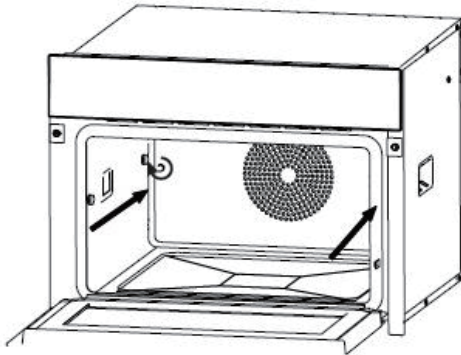



Note:

1. When fastening, use two thumbs and press with little force, so that the buckle of the steel frame can be snapped back to the fixing part easily.
2. Make sure that the oven cavity is cooled down, and then clean it after H icon disappears.

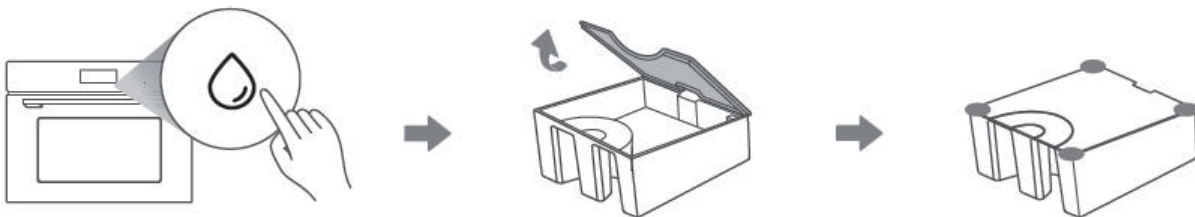
■ Removal and installation of water tank



Operation process:

1. Press  to raise the panel and take out the water tank
2. Open the water tank cover and clean
3. Install the water tank cover, please press the grey point in the picture to ensure it fits well
4. Put the water tank back to its original position, press  to lower the panel

Others

■ Troubleshooting

A. Possible Problems

| | Problem | Cause | Solution |
|---|--|--|--|
| 1 | No Display | Combi steamer is not connected to power supply | Ensure it is connected to power supply |
| | | Malfunction of power socket | Check if other electrical appliances work normally |
| | | Power cords is not working | Contact after-sales service |
| 2 | Combi steamer is not working | Power supply plug is not connected correctly | Try to plug in the power supply again |
| | | Oven door is not closed properly | Close the oven door again |
| | | Water tank is not in a correct position | Put the water tank back correctly |
| | | Circuit board is damaged | Contact after-sales service |
| | | Child lock is enabled | Disable the child lock |
| 3 | Display is not working properly | Display is damaged | Contact after-sales service |
| | | Circuit board is damaged | |
| 4 | Lots of Water or steam can be found during cooking | Oven door is not closed tightly | Close the oven door tightly again |
| | | Door seal is damaged | Contact after-sales service |
| 5 | Oven light is not working | Light is damaged | Contact after-sales service |
| | | Control board is damaged | |
| 6 | Fan motor fails to work properly | Fan motor is damaged | Contact after-sales service |
| | | Control board is damaged | |
| 7 | Control panel is not working properly | Control panel is out of order | Contact after-sales service |
| | | Control board is damaged | |
| 8 | No steam | Water tube is damaged | Contact after-sales service |
| | | Water pump is damaged | |
| | | Water tank is empty or not in place | |
| 9 | Water leakage | The water tank is not in a correct position | Fill the water tank and put it back correctly |

Others

B. Following conditions are normal

| | Condition | Cause |
|---|---|---|
| 1 | Fame and smell can be detected during the first time of use | These are emitted by the protective oil and it is normal. |
| 2 | Noise can be heard using any steam related mode | This is normal during water pumping into machine for steaming. |
| 3 | Water condensation can be found around the ventilation vent or door | The combi steamer produces a large amount of steam under steam cooking mode. Most of the steam will be vented from the frontal ventilation and some condensation water will be found around the ventilation vent. |
| 4 | The fan continues to work after cooking is finished | The fan will continue to run for 3 minutes after each cooking mode for cooling purpose to discharge oven heat completely. It is normal. |
| 5 | White powder can be found around the air inlet | This is water scale. It is normal. If white powder (water scale) is detected, it is recommended to run the Descaling Mode for cleaning purpose. |
| 6 | Bottom and cavity of oven's color has yellowing. | Stainless steel will generate yellow marks when heated and not kept clean. It is recommended to clean the combi steamer after each use to avoid the yellowing issue caused. |

Others

■ Product Specifications

| | |
|-------------------------------|---------------------|
| Model | W3MS450 |
| Rated Voltage and Frequency | 220-240V~50/60Hz |
| Rated Input Power | 2200W |
| Product Dimension (H x W x D) | 455 x 595 x 556 mm |
| Cavity Dimension (H x W x D) | 265 x 484 x 430 mm |
| Oven Capacity | 58L |
| Net Weight | Approximately 38 kg |

Register your product online

網上登記新產品保養

香港 Hong Kong



Scan QR Code or visit
www.whirlpool.com.hk
to register your product warranty online.

You can download the user manual by:

- Visiting Our website **www.whirlpool.com.hk**
- Contacting our Customer Service at (852) 2406 9138.

掃描二維碼或登入
www.whirlpool.com.hk
以進行網上產品保養登記

可透過以下途徑下載使用說明書:

- 瀏覽我們的網頁 **www.whirlpool.com.hk**
- 致電我們的客戶服務中心 (852)2406 9138

新加坡 Singapore



Scan QR Code or visit
www.whirlpool.com.sg/warranty-registration
to register your product warranty online.

You can download the user manual by:

- Visiting Our website **www.whirlpool.com.sg**
- Contacting our Customer Service at (65) 6250 6888 or email **helpdesk.sg@whirlpool.com**

掃描二維碼或登入
www.whirlpool.com.sg/warranty-registration
以進行網上產品保養登記

可透過以下途徑下載使用說明書:

- 瀏覽我們的網頁 **www.whirlpool.com.sg**
- 致電我們的客戶服務中心 (65)6250 6888 或電郵至 **helpdesk.sg@whirlpool.com**

Whirlpool® Registered trademark/TM Trademark of Whirlpool group of companies

All rights reserved - <http://www.whirlpool.com.hk>

註冊商標/惠而浦集團的TM商標

版權所有 翻印必究 - <http://www.whirlpool.com.hk>



Whirlpool