

Whirlpool

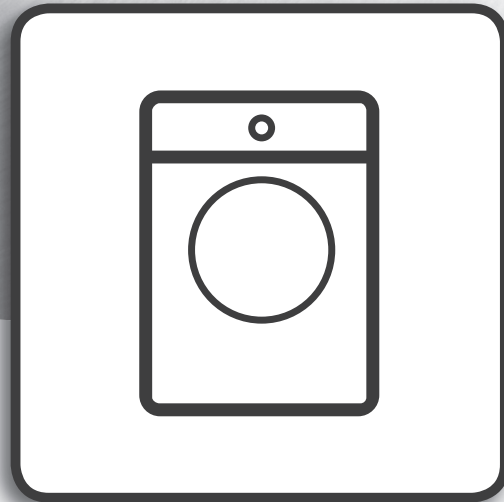

Health & Safety, Use & Care, Installation Guide and Online Warranty Registration Information

產品安全指引、使用說明、安裝指南及
網上登記保養資料

Model : TDLR70112

產品型號 : TDLR70112



www.whirlpool.com.sg
www.whirlpool.com.hk

ENGLISH 3

繁體中文 12

USER MANUAL



THANK YOU FOR BUYING A WHIRLPOOL PRODUCT.

Warranty information are at page 24 of the User Manual.

INDEX

USER MANUAL	3
Control Panel	4
Programme Chart	4
Product Description	4
Detergent Dispenser	4
Programmes	5
First Time Use.....	5
Daily Use	5
Pause or Change a Running Programme	5
Lid Open Indicator	5
Programme End	5
Options	5
Child Lock.....	6
Bleaching	6
Hints & Tips.....	6
Cleaning & Maintenance	6
Transport and Handling	6
Troubleshooting	7
Safety Instructions	8-9
Installation Guide	10-11

THANK YOU FOR BUYING A WHIRLPOOL PRODUCT.

In order to receive a more complete assistance, please register your product on www.whirlpool.com.hk/www.whirlpool.com.sg



Before using the appliance carefully read the Safety Instruction.

Before using the machine, it is imperative that the transport bracket is removed. For more detailed instructions on how to remove it, see the Installation Guide.

CONTROL PANEL

- 1 Programme selector
- 2 "Start/Pause" button ▷||
- 3 "Reset/Drain" button ⊗
- 4 "Start delay" button
- 5 Child lock combination =O 3 sec
- 6 "Spin" button
- 7 Time
- 8 Washing phase

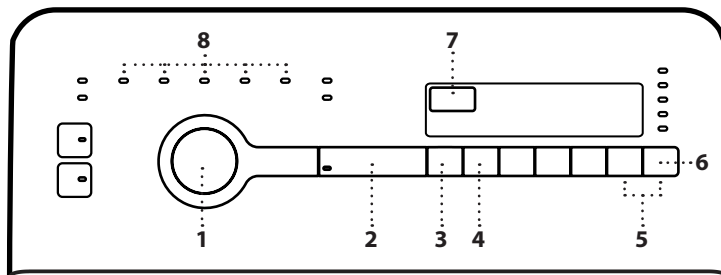

INDICATORS

- Lid open
- Failure: Call Service
- Failure: Water filter clogged
- Failure: No water

In the event of any failure, refer to the "TROUBLESHOOTING" section

PROGRAMME CHART

Programme	Max load 7,0 Kg					Detergents and additives			Recommended detergent		Options				
	Temperatures		Max. Spin speed (rpm)	Max load (kg)	Duration (h : m)	Prewash	Main wash	Softener	Powder	Liquid	Colors 15°	Fresh Care	Rapid	Prewash	Intensive Rinse
	Setting	Range													
Mixed 45'	40°C	40°C	1000	7,0	0:45	-	●	○	✓	✓	✓	✓	-	✓	-
Eco Cotton	60°C	40 - 60°C	1000	7,0	4:00	-	●	○	✓	✓	-	✓	-	-	✓
Antistain	20°C	20°C	1000	4,0	2:30	-	●	○	✓	✓	-	✓	-	-	✓
Wool	20°C	20°C	1000	1,0	0:35	-	●	○	-	✓	✓	✓	-	-	-
Spin	-	-	1000	7,0	**	-	-	-	-	-	-	✓	-	-	-
Rinse + Spin	-	-	1000	7,0	**	-	-	○	-	-	-	✓	-	-	✓
Delicates	30°C	30°C	1000	1,5	0:40	○	●	○	-	✓	✓	✓	-	✓	-
Synthetics	40°C	40°C	1000	3,0	1:50	○	●	○	✓	✓	✓	✓	✓	✓	✓
Hygiene	60°C	60°C	1000	7,0	2:30	-	●	●	✓	✓	-	✓	-	-	✓
Drum clean	90°C	90°C	0	0,0	1:20	-	●	○	✓	✓	-	✓	-	-	-
Cotton	60°C	40 - 90°C	1000	7,0	2:35	○	●	○	✓	✓	✓	✓	✓	✓	✓

● Dosing required ○ Dosing optional

Eco Cotton 60°C - Reference wash cycle.

This data may differ in your home due to changing conditions in inlet water temperature, water pressure etc. Approximate programme duration values refer to the default setting of the programmes, without options.

** The duration of the programme is shown on the display.

6th Sense - The sensor technology adapts water, energy and programme duration to your wash load.

PRODUCT DESCRIPTION

- 1. Lid handle
- 2. Lid
- 3. Control panel
- 4. Detergent dispenser
- 5. Drum
- 6. Water filter - behind the cover
- 7. Mobility lever (depending on model)
- 8. Adjustable feet (x2)

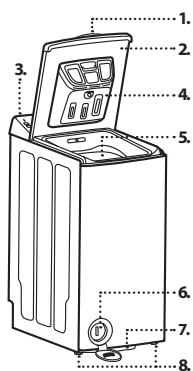

DETERGENT DISPENSER

Main wash compartment ▮▮

Detergent for the main wash, stain remover or water softener.

Prewash compartment ▮

Detergent for the prewash.

Softener compartment ⊗

Fabric softener. Liquid starch. Bleach.

Pour in softener, starch or bleach solution only up to the "max" mark.

Release button ↻

Press to remove tray for cleaning.

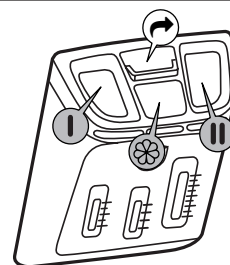

PROGRAMMES

For choosing the appropriate programme for your kind of laundry, always respect the instructions on the care labels of the laundry. The value given in the tub symbol is the maximum temperature possible for washing the garment.



Mixed 45'

For washing lightly to normally soiled garments in cotton, linen, synthetics fibers and mixed fibers in just 45 minutes.

Eco Cotton

For washing normally soiled cotton garments. At 40°C and 60°C, this is the standard cotton programme and the most efficient in terms of water and energy consumption.

Antistain

This programme ensures maximum stain removal capacity with no need for pre-treatment at low temperatures, preserving fabrics and colours.

Wool

All wool garments can be washed using programme, "Wool" even those carrying the "hand-wash only" label. For best results, use special detergents and **do not exceed max kg declaration of laundry**.

Spin

Spins the load then empties the water. For robust laundry.

Rinse + Spin

Separate rinse and intensive spin programme. For robust laundry.

Delicates

For washing particularly delicate garments. Preferably turn garments inside out before washing.

Synthetics

For washing soiled garments made from synthetic fibres (such as polyester, polyacrylic, viscose, etc.) or cotton/synthetic blends.

Hygiene

This program removes 99 % of bacteria while washing normally to heavily soiled bed linen, table linen and underwear, towels, shirts etc. made of cotton and linen.

Drum clean

Use this cycle every 40 washes to keep the inside of your washer fresh and clean. For optimal maintenance we suggest using Wpro Power Fresh Washer Odour Prevent Tab (AFR301) available at (<https://www.whirlpool.com.hk>). When using this cycle, the drum should be empty. This cycle should not be interrupted. The approximate cycle time is 80 minutes.

Cotton

Normally to heavily soiled and robust cottons.

FIRST TIME USE

To remove any manufacturing debris select the "Drum Clean" programme at a temperature of 90°C. Pour a small quantity of detergent powder into the main wash compartment of the detergent dispenser (maximum 1/3 of the quantity the detergent manufacturer recommends for lightly soiled laundry). Start the programme **without adding any laundry**.

DAILY USE

Prepare your laundry according to the recommendations in the "HINTS AND TIPS" section. Load the laundry, close the drum door and check that it is closed properly. Pour in the detergent and any additives. Observe the dosing recommendations on the detergent pack. Close the lid. Turn the programme selector to the desired programme and select any option if needed. The display shows the duration of the selected programme (in hours and minutes), and the indicator for the "Start/Pause" button flashes. The temperature and spin speed can be changed by pressing the "Temperature" button or the "Spin" button. Open the tap and press the "Start/Pause" button to start the wash cycle. The "Start/Pause" indicator will lights up and the door will be locked. Due to variations in load and temperature of inlet water, the remaining time is newly calculated in certain programme phases. If this is the case, an animation  appears on the time display.

PAUSE OR CHANGE A RUNNING PROGRAMME

To pause the wash cycle, press the "Start/Pause" button, the indicator light blinks. Select any new programme, temperature, options or spin speed if you wish to change those settings. Press the "Start/Pause" button again to start the wash cycle from the point at which it was interrupted. Do not add detergent for this programme.

LID OPEN INDICATOR

Before starting and after the end of a programme, the "Door open" indicator lights to show that the lid can be opened. As long as a wash programme is running, the lid remains locked and must on no account be forced open. In case you have an urgent need to open it during a running programme, for example to add more laundry, or to remove laundry which was loaded by mistake, press the "Start/Pause" button. If the temperature is not too high, the "Door open" indicator light turns on. It may last a while until you can open the lid. Press "Start/Pause" to proceed with the programme again.

PROGRAMME END

The "Door open" indicator lights up and the display shows E_{nd} . Turn the programme selector to the "O" position and close the water tap. Open the lid and drum and unload the machine. Leave the Lid open for some time to allow the interior of the machine to dry. After about a quarter of an hour, the washing machine will switch off completely to save energy. To cancel a running programme before the end of cycle, press the "Reset" button for at least 3 seconds. The water is drained out. It may last a while until you can open the lid.

OPTIONS

! When the combination of programme and additional option(s) is not possible, the indication lights switch off automatically.
! Unsuitable combinations of options are deselected automatically.

Start delay

To set the selected programme to start at a later time, press the "Start delay" button to set the desired delay time. The lamp for the "Start delay" option button lights up, and it goes off when the programme starts. Once having pressed the "Start/Pause" button, the countdown of the time delay begins. Number of hours pre-selected can be reduced by pressing the "Start delay" button again. **Do not use liquid detergent when activating this option.** To cancel the "Start delay" turn the programme selector to another position.

Rapid

Enables quicker washing by shortening the programme duration. Recommendable for small loads or only lightly soiled laundry.

Prewash

Only for heavily soiled loads (for example sand, granular dirt). Increases the cycle time by approximately 15 min. Do not use liquid detergent for the main wash when activating the Prewash option.

Favourite

If there is a programme setting which you use frequently, the appliance offers the possibility to save one setting for each programme so that it can be used again by just pushing one button.

To set it up:

Select the desired programme, spin speed and options, push and hold the "Favourite" button for at least 3 seconds. The lamp for "Favourite" button shortly flashes and then lights up - the programme settings is saved.

Next time you want to use your individual programme settings, select the programme, push the "Favourite" button and start by pushing "Start/Pause" button.

To replace a setting:

Select programme spin speed and options as desired and then press and hold the "Favourite" button for at least 3 seconds. The previously saved programme setting will be replaced by the new one.

Intensive rinse

Helps to avoid detergent residues in the laundry by extending the rinse phase. Particularly suitable for washing baby laundry, for people suffering from allergies and for areas with soft water.

Spin

Every programme has a predefined spin speed. If you want to change the spin speed, press the "Spin" button. If spin speed "0" is selected, the final spinning is cancelled but intermediate spin peaks remain during the rinse. The water is drained out only.

Colours 15°

Saves energy used for water heating while maintaining a good wash result. Supports colour maintenance when washing coloured laundry. Recommendable for lightly soiled laundry without stains. Make sure that your detergent is suitable for cold wash temperatures.

FreshCare

Select this option if you cannot unload the laundry soon after programme end, or if you tend to forget the laundry in your washing machine. It will help to keep your laundry fresh. The washing machine will start to tumble the laundry periodically after programme end. The light of the "FreshCare" button will blink while this function is active, and the display will show an animation. The periodic tumbling will last up to approximately 6 hours after the end of your wash programme, and you can stop it at any time by pressing the "FreshCare" button. It will last a while until you can open the door. After the "FreshCare" period has run out, the display indicates E_{nd} .

CHILD LOCK \rightarrow 3 sec

You can lock the buttons of the control panel against improper use (e.g. by children). Press both of the child lock buttons simultaneously and hold them for at least 3 seconds. The key symbol  on the display lights up. To unlock the buttons again proceed in the same way.

BLEACHING

Wash your laundry in the desired programme, Cotton or Synthetics, adding an appropriate amount of chlorine bleach to the Softener  chamber (close the lid carefully). Immediately after the end of the programme, turn the "Programme selector" and start the desired programme again to eliminate any residual bleach smell; if you want, you can add softener. **Never put both chlorine bleach and softener into the softener chamber at the same time.**

HINTS AND TIPS

Sort your laundry according to

Type of fabric/care label (cotton, mixed fibres, synthetics, wool, handwash items). Colour (separate coloured and white items, wash new coloured items separately). Delicates (wash small items – like nylon stockings – and items with hooks – like bras – in a cloth bag or pillow case with zip).

Empty all pockets

Objects like coins or lighters can damage your laundry as well as the drum.

Appliance interior

If you never or seldom wash your laundry at 90°C, we recommend to occasionally run a Drum Clean Programme without laundry, adding a small amount of detergent, to keep the interior of the appliance clean.

Follow the dosage recommendation / additives

It optimizes the cleaning result, it avoids irritating residues of surplus detergent in your laundry and it saves money by avoiding waste of surplus detergent

Use low temperature and longer duration

The most efficient programmes in terms of energy consumption are generally those that perform at lower temperatures and longer duration.

Observe the load sizes

Load your washing machine up to the capacity indicated in the "PROGRAMME CHART" table to save water and energy.

Noise and remaining moisture content

They are influenced by the spinning speed: the higher the spinning speed in the spinning phase, the higher the noise and the lower the remaining moisture content.

CLEANING & MAINTENANCE

For any cleaning and maintenance, switch off and unplug the washing machine. Do not use flammable fluids to clean the washing machine. Clean and maintain your washing machine periodically (at least 4 times per year).

Cleaning the outside of the washing machine

Use a soft damp cloth to clean the outer parts of the washing machine. Do not use glass or general purpose cleaners, scouring powder or similar to clean the control panel – these substances might damage the printing.

Detergent dispenser

Clean regularly, at least three or four times a year, to prevent detergent build-up:

Press the release button  to release the detergent dispenser and remove it. A small quantity of water can remain in the dispenser, thus you should carry it in an upright position. Wash the dispenser using running water. You can also remove the siphon cap on the back of the dispenser for cleaning. Replace the siphon cap in the dispenser (if removed) Reinstall the dispenser by locating the dispenser's bottom tabs into the appropriate openings on the lid, and by pushing the dispenser against the lid until it locks into place. **Make sure that the detergent dispenser is correctly reinstalled.**

Checking the water supply hose

Check the inlet hose regularly for brittleness and cracks. If damaged, replace it by a new hose available through our After-Sales Service or your specialist dealer. Depending on the hose type: If the inlet hose has a transparent coating, periodically check if the colour intensifies locally. If yes, the hose may have a leak and should be replaced. For water stop hoses  (if available): check the small safety valve inspection window (see arrow). If it is red, the water stop function was triggered, and the hose must be replaced by a new one. For unscrewing this hose, press the release button (if available) while unscrewing the hose.

Cleaning the mesh filters in the water supply hose

Check and clean regularly (at least two or three times a year).

Close the tap and loosen the inlet hose on the tap. Clean the internal mesh filter and screw the water inlet hose back onto the tap. Now unscrew the inlet hose on the rear of the washing machine. Pull off the mesh filter from the washing machine connection with universal pliers and clean it. Refit the mesh filter and screw the inlet hose on again. Turn on the tap and ensure that the connections are completely water-tight.

Cleaning the water filter / draining residual water

The washing machine is provided with a self-cleaning pump. The filter keeps objects like buttons, coins, safety pins etc. which have been left in the laundry. If you used a hot wash programme, wait until the water has cooled down before draining any water. Clean the water filter regularly, to avoid that the water cannot drain after the wash due to obstruction of the filter. If the water cannot drain, the indicator indicates that the water filter may be clogged.

Open the filter cover with a coin. Place a broad, flat container beneath the water filter, to collect the drain water. Slowly turn the filter counterclockwise until water flows out. Let the water flow out, without removing the filter. When the container is full, close the water filter by turning it in clockwise. Empty the container. Repeat this procedure until all the water has drained. Lay a cotton cloth beneath the water filter, which can absorb a small amount of rest water. Then remove the water filter by turning it out anti clockwise. Clean the water filter (remove residues in the filter and clean it under running water) and the filter chamber. Make sure the pump impeller (in the housing behind the filter) is not obstructed. Insert the water filter and close the filter cover: Reinsert the water filter again by turning it in clockwise direction. Make sure to turn it in as far as it goes. To test water tightness of the water filter, you can pour about 1 liter of water into the drum and check that water does not leak from the filter. Then close the filter cover.

Lid seal

Check the condition of the lid seal periodically and clean it from time to time with a damp cloth.

Recovering an object that falls between the drum and the tub

If an object accidentally falls between the drum and the tub, you can recover it thanks to one of the removable drum lifters.

1. Unplug the washing machine. Remove the laundry from the drum.
2. Close the drum flaps and turn the drum a half-turn (picture **a**).
3. Using a screw-driver press on the plastic end, while sliding the lifter from left to right (picture **b, c**) by hand it will fall into the drum.
4. Open the drum. You can recover the object through the hole in the drum.
5. Refit the lifter from inside the drum: Position the plastic tip above the hole on the right side of the drum (picture **d**). Then slide the plastic lifter from right to left until it clips.
6. Close the drum flaps again, turn the drum through half a turn and check the positioning of the blade at all its anchorage points.
7. Plug the washing machine in again.

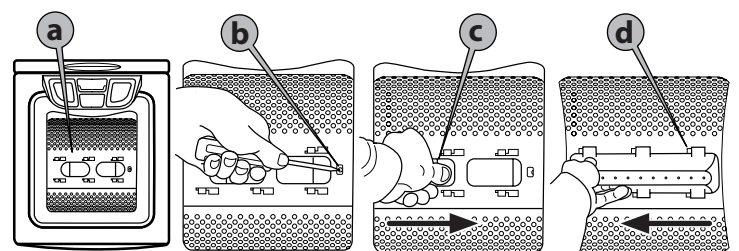









TRANSPORT AND HANDLING

Pull out the mains plug, and close the water tap. Disconnect the inlet hose from the water tap, and remove the drain hose from your draining point. Remove all rest water from the hoses and washing machine and fix hoses so that they cannot get damaged during transport. To facilitate moving the machine, pull the mobility lever situated at the bottom front (if available on your model) out a little by hand. Pull the washing machine out to the stop with the foot. Afterwards push the mobility lever back into the original stable position. Refit the transport bracket. Follow the instructions for removing the transport bracket in the **INSTALLATION GUIDE** in reverse order.

TROUBLESHOOTING

The washing machine may sometimes not work properly for certain reasons. Before calling the After-sales service, it is recommended to check to see if the problem can be easily resolved using the following list.

Problems:	Possible causes / Solution:
The washing machine does not turn on and/ or programme does not start	<ul style="list-style-type: none"> • The plug is not inserted into the electrical outlet, or not enough to make contact. • There has been a power failure. • Lid is not properly closed. • The "Child lock"  3 sec function has been activated (if available). • The washing machine switched off automatically to save energy, before programme start or after programme end. To switch on the washing machine, turn the programme selector first to "Off/O" and then to the desired programme again.
The wash cycle does not start.	<ul style="list-style-type: none"> • The "Start/Pause"  button has not been pressed. • The water tap is not open. • A "Start delay" has been set.
Appliance stops during the programme, and the "Start/Pause"  light blinks	<ul style="list-style-type: none"> • "Rinse hold" option is activated (if available). • Programme has been changed - re-select desired programme and press "Start/Pause" .
Appliance vibrates	<ul style="list-style-type: none"> • The washing machine is not level. • The transport bracket has not been removed; before using the washing machine, the transport bracket must be removed.
Final spin results are poor. The laundry is still very wet. "Spin/Drain" indicator blinks, or the spin speed on the display blinks, or the spin speed indicator blinks after the end of the programme - depending on the model	<ul style="list-style-type: none"> • Unbalance of the laundry load during spinning prevented the spin phase to avoid damages on the washing machine. This is why the laundry is still very wet. Reason for unbalance can be: small laundry loads (consisting of only few quite big or absorbent items, e.g. towels), or big/heavy laundry items. • If possible avoid small laundry loads. • "Spin" button has been set to a low spin speed.
The machine is indicating an error code (e.g. F-02, F-..) and/or "Service"  indicator lights up	<ul style="list-style-type: none"> • Shut off the machine, disconnect the plug from the outlet, and wait about 1 minute before turning it back on. • If the problem persists, call the After-sales service.
"Clean pump"  indicator lights up	<ul style="list-style-type: none"> • Waste water is not pumped out. • Clean the water filter
"Water tap closed"  indicator lights up	<ul style="list-style-type: none"> • Appliance has no or insufficient water supply.
"Detergent over dosage"  indicator lights up (if available)	<ul style="list-style-type: none"> • The symbol will light up at the end of the programme if you used too much detergent. • Too much foam is formed. • The detergent is not compatible with the washing machine (it must bear the wording "for washing machines", "for hand washing and washing machines", or something similar).

SAFETY INSTRUCTIONS

IMPORTANT TO BE READ AND OBSERVED

Before using the appliance, read these safety instructions. Keep them nearby for future reference. These instructions and the appliance itself provide important safety warnings, to be observed at all times. The manufacturer declines any liability for failure to observe these safety instructions, for inappropriate use of the appliance or incorrect setting of controls.

⚠ Very young children (0-3 years) should be kept away from the appliance. Young children (3-8 years) should be kept away from the appliance unless continuously supervised. Children from 8 years old and above and persons with reduced physical, sensory or mental capabilities or lack of experience and knowledge can use this appliance only if they are supervised or have been given instructions on safe use and understand the hazards involved. Children must not play with the appliance. Cleaning and user maintenance must not be carried out by children without supervision.

Never open the door forcibly or use it as a step.

PERMITTED USE

⚠ CAUTION: The appliance is not intended to be operated by means of an external switching device, such as a timer, or separate remote controlled system.

⚠ This appliance is intended to be used in household and similar applications such as: staff kitchen areas in shops, offices and other working environments; farm houses; by clients in hotels, motels, bed & breakfast and other residential environments.

⚠ Do not load the machine above the maximum capacity (kg of dry cloth) indicated in the programme table.

⚠ This appliance is not for professional use. Do not use the appliance outdoors.

⚠ Do not use any solvents (e.g. turpentine, benzene), detergents containing solvents, scouring powder, glass or general purpose cleaners, or flammable fluids; do not machine wash fabrics that have been treated with solvents or flammable liquids.

INSTALLATION

⚠ The appliance must be handled and installed by two or more persons - risk of injury. Use protective gloves to unpack and install - risk of cuts.

If you want to stack a dryer on top of your washing machine, first contact our After-Sales Service or your specialist dealer to verify whether this is possible. This is only possible if the dryer is attached to the washing machine by means of appropriate stacking kit available through our After-Sales Service or your specialist dealer.

⚠ Move the appliance without lifting it by the worktop or top lid.

⚠ Installation, including water supply (if any) and electrical connections and repairs must be carried out by a qualified technician. Do not repair or replace any part of the appliance unless specifically stated in the user manual. Keep children away from the installation site. After unpacking the appliance, make sure that it has not been damaged during transport. In the event of problems, contact the dealer or your nearest After-sales Service. Once installed, packaging waste (plastic, styrofoam parts etc.) must be stored out of reach of children - risk of suffocation. The appliance must be disconnected from the power supply before any installation operation - risk of electric shock. During installation, make sure the appliance does not damage the power cable - risk of fire or electric shock. Only activate the appliance when the installation has been completed.

⚠ Do not install your appliance where it may be exposed to extreme conditions, such as: poor ventilation, temperatures below 5 °C or above 35 °C.

⚠ When installing the appliance make sure that the four feet are stable and resting on the floor, adjusting them as required, and check that the appliance is perfectly to level using a spirit level.

⚠ If the appliance is being installed on wood or "floating" floors (certain parquet and laminate materials), secure a 60 x 60 x 3 cm (at least) sheet of plywood to the floor then place the appliance on top of this.

⚠ Connect the water inlet hose(s) to the water supply in accordance with the regulations of your local water company.

⚠ For cold fill only models: do not connect to the hot water supply.

⚠ For models with hot fill: the hot water inlet temperature must not exceed 60 °C.

⚠ The washing machine is fitted with transport bolts to prevent any possible damage to the interior during transport. Before using the machine, it is imperative that the transport bolts are removed. After their removal, cover the openings with the 4 enclosed plastic caps.

⚠ After installation of the device, wait a few hours before starting it so that it acclimates to the environmental conditions of the room.

⚠ Make sure that the ventilation openings in the base of your washing machine (if available on your model) are not obstructed by a carpet or other material.

⚠ Use only new hoses to connect the appliance to the water supply. The old hose-sets should not be reused.

⚠ The supply water pressure must be in the 0.1-1 Mpa range.

ELECTRICAL WARNINGS

⚠ It must be possible to disconnect the appliance from the power supply by unplugging it if plug is accessible, or by a multi-pole switch installed upstream of the socket in accordance with the wiring rules and the appliance must be earthed in conformity with national electrical safety standards.

⚠ Do not use extension leads, multiple sockets or adapters. The electrical components must not be accessible to the user after installation. Do not use the appliance when you are wet or barefoot. Do not operate this appliance if it has a damaged power cable or plug, if it is not working properly, or if it has been damaged or dropped.

⚠ If the supply cord is damaged, it must be replaced with an identical one by the manufacturer, its service agent or similarly qualified persons in order to avoid a hazard - risk of electric shock.

CLEANING AND MAINTENANCE

⚠ WARNING: Ensure that the appliance is switched and disconnected from the power supply before performing any maintenance operation. To avoid risk of personal injury use protective gloves (risk of laceration) and safety shoes (risk of contusion); be sure to handle by two persons (reduce load); never use steam cleaning equipment (risk of electric shock).

Non-professional repairs not authorized by the manufacturer could result in a risk to health and safety, for which the manufacturer cannot be held liable. Any defect or damage caused from non-professional repairs or maintenance will not be covered by the guarantee.

DISPOSAL OF PACKAGING MATERIALS

The packaging material is 100% recyclable and is marked with the recycle symbol .

The various parts of the packaging must therefore be disposed of responsibly and in full compliance with local authority regulations governing waste disposal.

DISPOSAL OF HOUSEHOLD APPLIANCES

This appliance is manufactured with recyclable or reusable materials. Dispose of it in accordance with local waste disposal regulations. For further information on the treatment, recovery and recycling of household electrical appliances, contact your local authority, the collection service for household waste or the store where you purchased the appliance. This appliance is marked in compliance with European Directive 2012/19/EU, Waste Electrical and Electronic Equipment (WEEE). By ensuring this product is disposed of correctly, you will help prevent negative consequences for the environment and human health.

The symbol on the product or on the accompanying documentation  indicates that it should not be treated as domestic waste but must be taken to an appropriate collection center for the recycling of electrical and electronic equipment.

INSTALLATION GUIDE

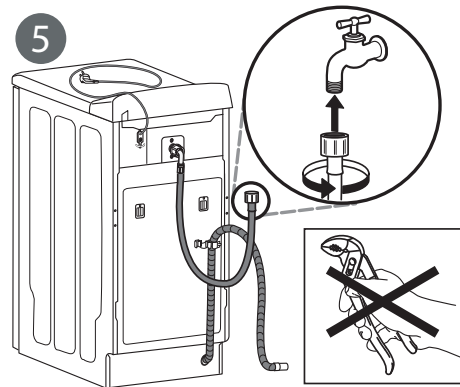
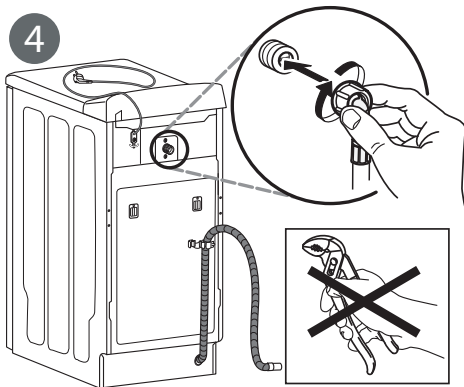
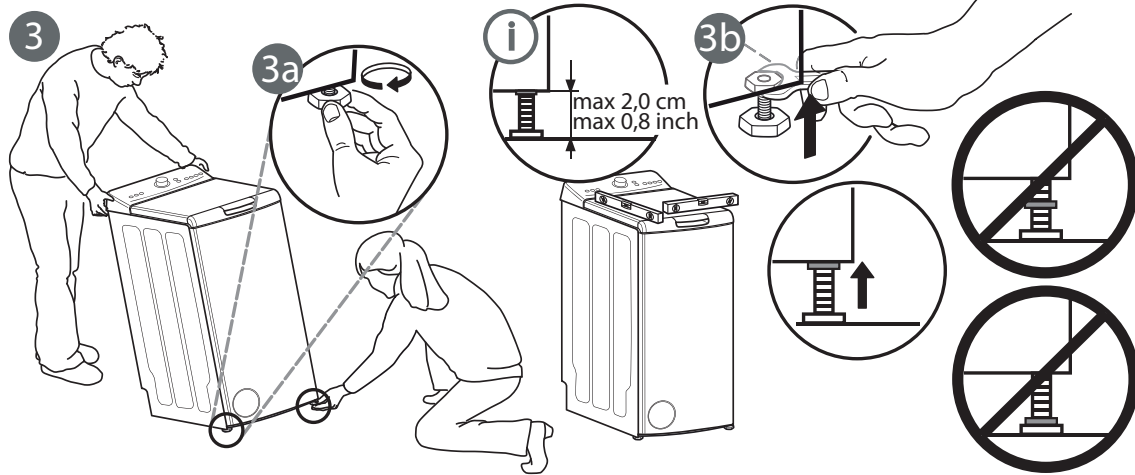
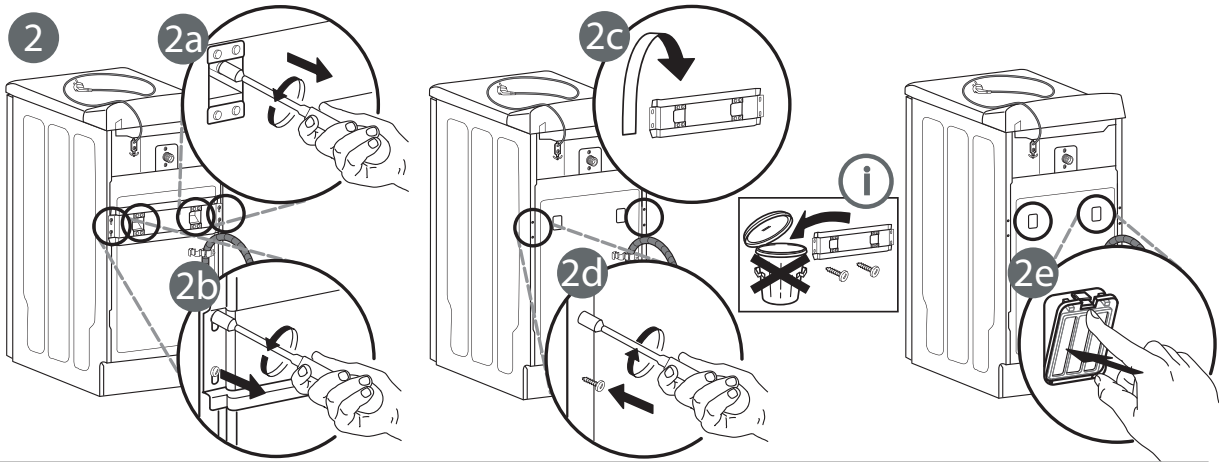
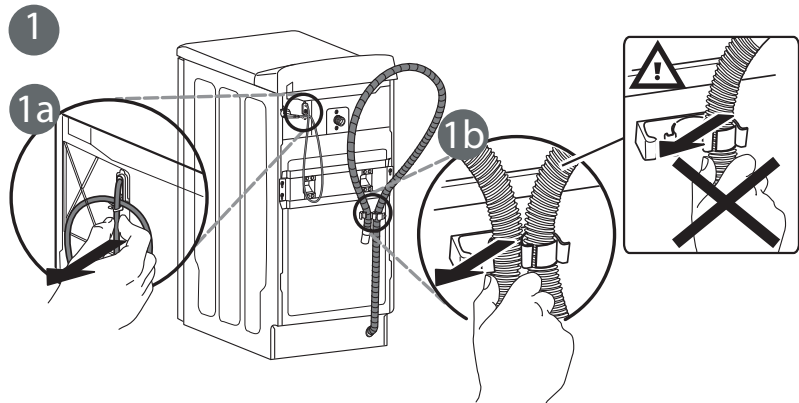
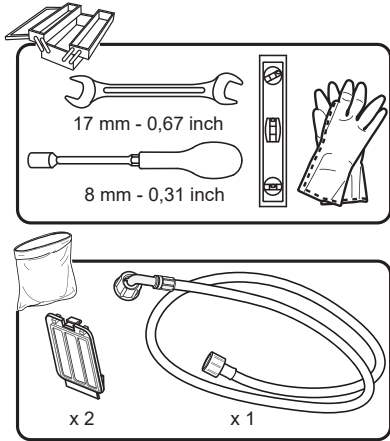

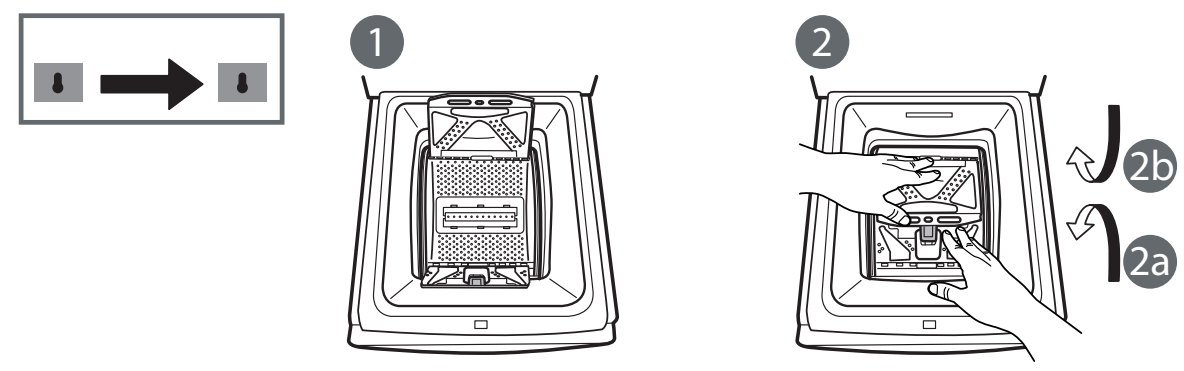
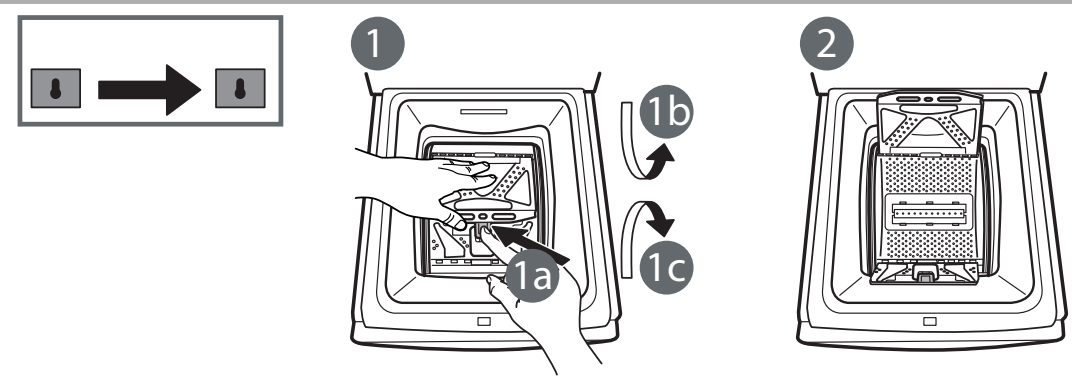
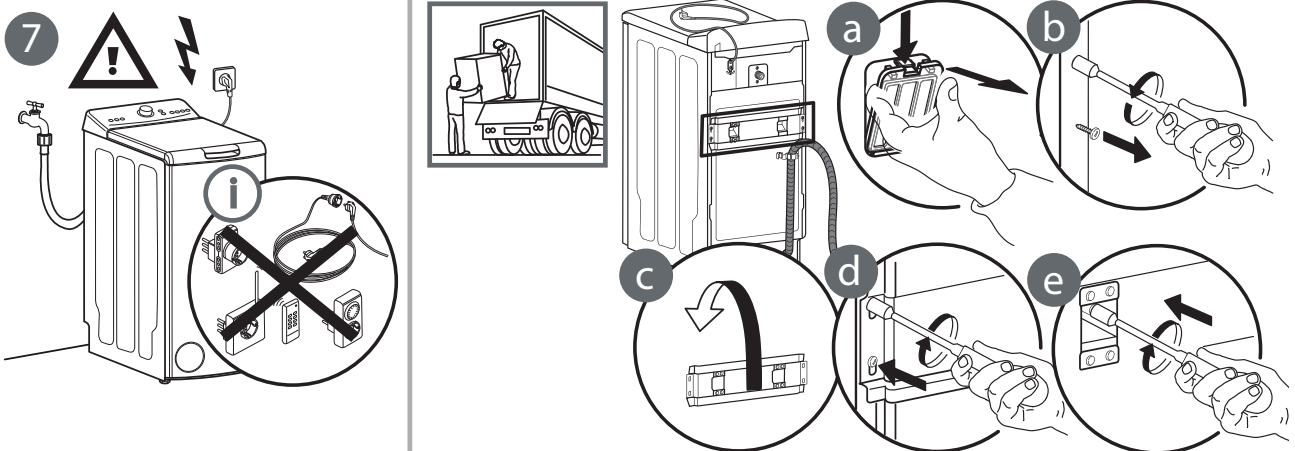
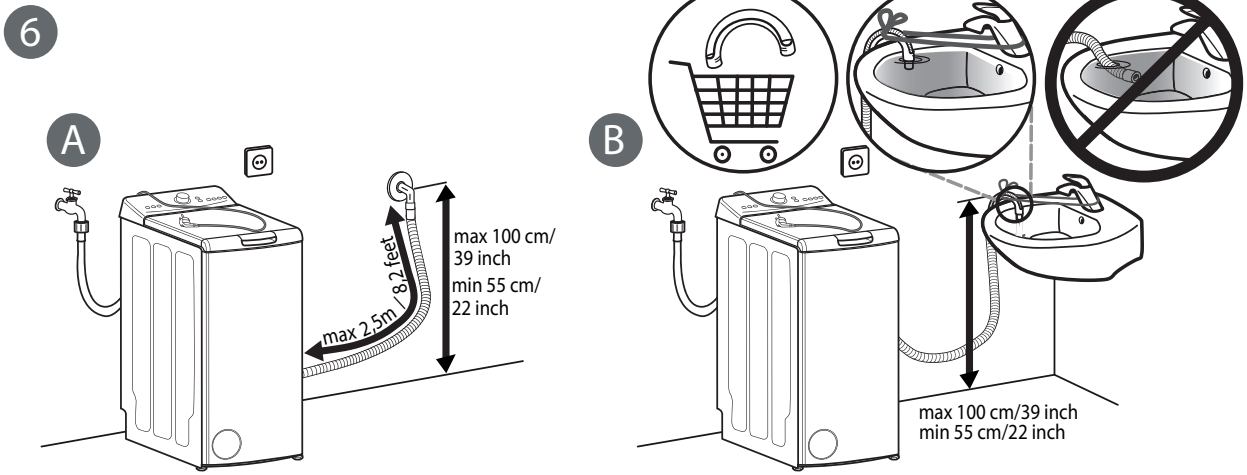

使用說明書



感謝您購買惠而浦產品
為了獲得更完善的服務，
有關保養資訊請參考第24頁

索引

使用說明書	12
控制面板	13
程序表	13
產品介紹	13
洗滌劑投放盒	13
洗衣程序說明	14
首次使用	14
日常使用	14
程序運行過程中暫停或變更設定	14
開門指示燈	14
程序結束	14
功能選項	14
童鎖	15
使用含氯漂白劑	15
提示與貼士	15
保養及維護	15
搬運及處理	15
故障排除指南	16
安全說明	17-18
安裝指引	19-20



感謝您購買惠而浦產品
為了獲得更完善的服務，
請於www.whirlpool.com.hk註冊您的產品



使用洗衣機前請先細閱產品安全指引。
使用洗衣機前，必須先卸下包裝。有關如何拆除包裝的更多詳細說明，請參閱《安裝指南》。

控制面板

- 1 程序選擇扭掣
- 2 「開始/暫停鍵」▷||
- 3 「重設/排水」鍵 ⊗
- 4 「預校開機時間」鍵
- 5 「童鎖」=○3sec
- 6 「脫水轉速」鍵
- 7 時間顯示
- 8 程序步驟顯示燈

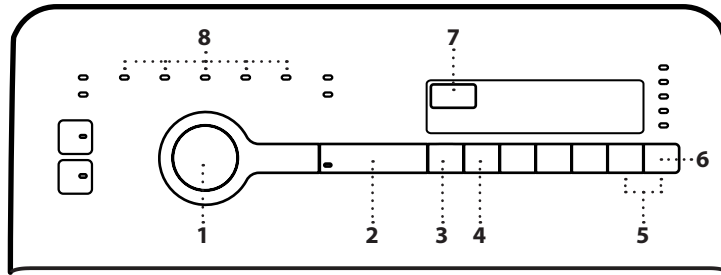

- 指示燈
「開門」指示燈 ◻
- 診斷故障：
「檢修」指示燈 ⊗
「清潔排水泵」指示燈 ⊕
「水龍頭關閉」指示燈 ⚡

如果發生任何故障，請參閱「故障排除指南」部分

程序表

程序	最高洗衣量為7公斤					洗衣劑及添加劑			建議洗滌劑		功能選項				
	溫度		最高轉速 (轉/分鐘)	建議 洗衣量 (公斤)	洗衣時間 (小時:分鐘)	預洗 	主洗 	柔順劑 ⊗	洗衣粉	洗衣液	護色15° ✓	皺 潔	快 洗	預 洗	水 過
	預設	可選範圍													
45分鐘混合洗	40°C	40°C	1000	7,0	0:45	-	●	○	✓	✓	✓	-	-	-	
棉質節能洗	60°C	40 - 60°C	1000	7,0	4:00	-	●	○	✓	✓	-	-	-	✓	
高效除漬	20°C	20°C	1000	4,0	2:30	-	●	○	✓	✓	-	-	-	✓	
羊毛(手洗)	20°C	20°C	1000	1,0	0:35	-	●	○	-	✓	✓	-	-	-	
脫水	-	-	1000	7,0	**	-	-	-	-	-	✓	-	-	-	
過水及脫水	-	-	1000	7,0	**	-	-	○	-	-	-	-	-	✓	
纖細衣物	30°C	30°C	1000	1,5	0:40	○	●	○	-	✓	✓	-	✓	-	
合成纖維	40°C	40°C	1000	3,0	1:50	○	●	○	✓	✓	✓	✓	✓	✓	
高效殺菌	60°C	60°C	1000	7,0	2:30	-	●	●	✓	✓	-	-	-	✓	
清潔滾筒	90°C	90°C	0	0,0	1:20	-	●	○	✓	✓	-	-	-	-	
棉質	60°C	40 - 90°C	1000	7,0	2:35	○	●	○	✓	✓	✓	✓	✓	✓	

● 需按劑量 ○ 自選劑量

棉質節能洗 60°C- 參考程序

由於進水溫度、水壓等條件的變化，您家中洗衣機跟上述這些數據可能會有所不同。近似的程序持續時間值是指程序的默認設置，沒有選項。

** 程序時間會顯示在顯示屏上。

第六感智能感應 - 此技術會因應您所清洗的衣物量負載去調節用水量、能源和程序時間。

產品介紹

1. 機門把手
2. 機門
3. 控制面板
4. 洗滌劑投放盒
5. 滾筒
6. 過濾器 - 被蓋子覆蓋
7. 滾輪拉桿 (視乎型號而定)
8. 可調校機腳 (x2)

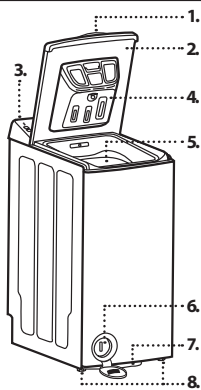

洗滌劑投放盒

主洗格 ||
放置用於主洗的洗滌劑或去污劑。

預洗格 |
放置用於預洗的洗滌劑

柔順劑格 ⊗
將衣物柔順劑/漂白劑注入此格。
注入柔順劑/漂白劑時請不要超過「最高」注入量。

洗滌劑投放盒拆除鍵 ↻
按下此鍵將洗滌劑投放盒拆出以便清洗。

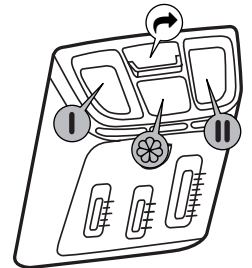

洗衣程序說明

選擇適合您的衣物的洗衣程序時，請遵守衣物保養標籤上的說明。符號上標出的值是洗滌衣物的最高可能接受溫度。



45分鐘混合洗

僅需45分鐘就能完成洗滌輕度至中度骯髒之棉質、尼龍、合成纖維和混合纖維的衣服。

棉質節能洗

用於洗滌一般骯髒的棉質衣服。在40°C和60°C的溫度下，這是標準的棉質清洗程序，並且在水和能源消耗方面效率為最高。

高效除漬

該程序可確保最大的去污能力，而無需在中低溫下進行預處理，從而保留織物細緻和顏色。

羊毛(手洗)

可以使用「羊毛」程序洗滌所有羊毛服裝，包括標有「僅手洗」標籤的服裝。為了獲得最佳效果，請使用特殊的洗滌劑，並且不要超過衣物的最大聲明重量。

脫水

脫水後來會進行排水。

過水及脫水

分別進行過水及脫水程序。用於材質較堅固耐用的衣物。

纖細衣物

用於洗滌特別纖細的衣物。最好在洗滌之前將衣物內翻。

合成纖維

用於洗滌由合成纖維（例如尼龍、聚丙稀酸酯、粘膠纖維等）或由棉及合成纖維混紡製成的骯髒衣服。

高效殺菌

此程序在洗滌中等程度至較多污漬的床單、毛巾、襯衫等由棉和亞麻製成的衣物時，可去除99%的細菌。

清潔滾筒

每經過40次洗滌程序後，請使用此清洗程序以保持洗衣機內部清潔。為了實現最佳效果，我們建議使用Wpro 洗衣機除味片 (AFR301) - 現於下列網址有售 (<https://www.whirlpool.com.hk>)。使用此清洗程序時，需要清空滾筒內所有衣物。請不要在程序開始後突然中斷清洗程序。整個程序大概需時80分鐘。

棉質

一般至污漬較多的棉質衣物。

首次使用

請運行一次溫度90°C的「清潔滾筒」程序，進行洗機。於滾筒內放入一片Wpro洗衣機除味片，或將少量洗滌劑粉末倒入洗滌劑投放盒的主洗格中 II (最大用量不超過洗滌劑製造商建議用作清洗輕度污染衣物的建議量的1/3)。請在不添加任何衣物的情況下啟動程序。

日常使用

根據「提示和技巧」部分中的建議準備衣物。裝入衣物，關上洗衣機門後，再次檢查機門是否已正確關閉。倒入洗衣液和其他所需衣物洗滌劑。請遵守洗衣液包裝上的劑量建議。關上機門後，旋轉程序選擇器選擇所需程序，然後根據需要選擇其他所需選項。顯示屏顯示所選程序的所需時間（以小時和分鐘為單位），「開始/暫停」按鈕的指示燈閃爍。可以按「溫度」按鈕或「脫水轉速」按鈕調校溫度和脫水轉速。打開水龍頭，然後按「開始/暫停」▶️ 按鈕開始洗滌循環。此時「開始/暫停」▶️ 指示燈將會點亮，並且機門將被鎖定。由於進水所造成的負荷和溫度的變化，剩餘時間將會於程序運行時的特定階段中重新計算及調整，並於時間顯示屏上顯示此符號 。

程序運行過程中暫停或變更設定

若需中途暫停清洗程序，請按「開始/暫停」▶️ 按鈕，此時指示燈會閃爍。若要更改程序設定，請選擇任何新的程序、溫度、選項或轉速。再次按下「開始/暫停」▶️ 按鈕，洗衣機將會從程序中斷點繼續進行。此程序無需添加洗衣劑。

「開門」指示燈

開始一個程序前和結束一個程序後，「開門」指示燈 會亮起表示可以打開機門。洗衣程序運行期間，機門保持上鎖，決不能強行打開。如果在洗衣程序運行期間你急需打開機門，例如添加更多衣物，或從滾筒裏拿走錯誤放入的衣物，請按下「開始/暫停」▶️ 按鈕。若此時滾筒內溫度不是太高，「開門」指示燈 會亮起，你或需等待片刻才能打開機門。及後，請再次按下「開始/暫停」▶️ 按鈕繼續剛才的洗衣程序。

程序結束

「開門」指示燈 會亮起。將程序選擇扭擊轉到「O」並關閉水龍頭。打開機門及滾筒蓋並取出衣物。讓機門開啓一段時間，使洗衣機的內部風乾。大約15分鐘後，洗衣機會關機以節省能源。若想於洗衣程序完結前取消程序，長按3秒「重設」按鍵 。洗衣機將會進行排水，或需等待片刻才能打開機門。

功能選項

！當所選的功能選項不能與所選的洗衣程序同時應用，指示燈將自動熄滅。！若選項與程序組合不適當，洗衣機將會自動取消選擇。

預校開機時間

要將所選程序設置為稍後啟動，請按「預校開機時間」按鈕以設置所需的延遲時間。「預校開機時間」選項的指示燈點亮，並且在程序啟動時熄滅。按下「開始/暫停」按鈕後，將會開始倒數計時。再次按下「預校開機時間」按鈕，可以減少預選的時間。揀選此選項時，請勿使用液體洗滌劑。若想取消「預校開機時間」，請將程序選擇器轉到另一個位置。

快速

通過縮短程序時間，可以更快地進行清洗。建議用於少量衣物或輕度骯髒的衣物。

預洗

只適用於較骯髒的衣物，（例如沾有沙粒、粒狀污垢的衣物）。點選後，程序時間將會增加約15分鐘。若已揀選「預洗」選項，請勿在主洗格中加入洗衣液。

自選程序

如果您經常使用某個程序設置，則設備可以為每個程序保存一個設置，日後只需按一個按鈕就可以再次使用它。

進行設置：

選擇所需的程序、旋轉速度和選項，然後按住「自選程序」按鈕至少3秒。「自選程序」按鈕的指示燈會短暫閃爍，然後亮起-程序設置已保存。

下次您要使用自己保存的程序設置時，選擇程序，按「自選程序」按鈕，然後按「開始/暫停」▶️ 運行程序。

替換設置：

根據需要選擇旋轉速度和選項，然後按住「自選程序」按鈕至少3秒。以前保存的程序設置將被新的設置代替。

深層過水

通過延長過水階段，有助於避免洗衣粉殘留在衣物上。特別適合用於洗滌嬰兒衣物、過敏症患者的衣物或使用軟水的地區。

脫水轉速

每個程序都有預設的轉度。如果要更改轉度，請按「脫水轉速」按鈕。如果選擇旋轉速度為「0」，則取消脫水階段，但在漂洗過程中仍然會保留特定轉速僅作排水用途。

護色 15°

節省用於熱水的能量，同時保持良好的洗滌效果。洗滌彩色衣物時能有效保護衣物顏色。建議用於沒有污漬且輕度骯髒的衣物。請確保您所用的洗滌劑適合冷水溫度。

清爽抗皺

如果您無法在程序結束後立即取出衣物，或經常會忘記立即拿出洗衣機中的衣物，請選擇此選項。這功能選項有助於保持您的衣物清爽。程序結束後，洗衣機將開始定期翻滾衣物。當此功能啟用時，「清爽抗皺」按鈕的指示燈將閃爍，顯示屏將顯示動畫。定期的翻滾過程會在您的洗滌程序結束後持續約6個小時，您可以隨時按「清爽抗皺」按鈕將其停止。您需要稍後片刻才能打開機門。「清爽抗皺」結束後，顯示屏將會顯示 End 。

童鎖 =O 3 sec

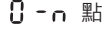
您可以鎖定控制面板上的按鈕以防止不當使用（例如兒童使用）。同時按下兩個童鎖按鈕，維持至少3秒。顯示屏上的鑰匙符號  點亮。再次解鎖，請以相同方式操作。

使用含氯漂白劑

用所需的程序（棉質或合成纖維）洗滌衣物，並在柔順劑格  中加入適量的漂白劑（小心地關上蓋子）。洗衣程序結束後，立即轉動「程序選擇器」並再次啟動所需的程序，以消除任何殘留的漂白劑氣味。如有需要，可以添加柔順劑。切勿將漂白劑和柔順劑同時放入柔順劑格中。

提示與貼士

衣物分類

根據織物/護理標籤的類型進行分類（棉質、混合纖維、合成纖維、羊毛、洗手衣物）。顏色（將彩色和白色物品分開清洗）。精緻的衣服（將小物件-如尼龍長襪-和帶鉤的物件-如胸罩-放在布袋或帶拉鍊的枕頭套中進行清洗）。

清空所有口袋

硬幣或打火機等物品可能會損壞您的衣物以及滾筒。

洗衣機內部

如果您從未或很少在90°C下洗衣服，我們建議您偶爾在不洗衣服的情況下運行「清潔滾筒」程序程序，並添加少量清潔劑，以保持設備內部清潔。

遵循洗衣劑/添加劑的劑量建議

這樣可以優化清潔效果，避免衣物中殘留多餘洗滌劑，避免浪費洗滌劑同時可節省資金。

使用較低溫度及較長程序時間

就能源消耗角度而言，最有效的程序通常是在較低溫度和較長時間下執行的程序。

觀察衣物量多少

按照「程序表」中的建議衣物量放置衣物，從而節省水和能源。

噪音和殘留水分

它們受轉速影響：脫水階段的轉速越高，噪音越高，殘留的水分就越少。

保養及維護

若需進行任何保養和維護，請關閉電源並拔下電源插頭。請勿使用易燃液體清潔洗衣機。請定期清潔和維護洗衣機（每年至少4次）

清潔洗衣機外部

請使用柔軟的濕布清潔洗衣機的外部。請勿使用玻璃清潔劑或通用清潔劑、去污粉或類似物品清潔控制面板，因為這些清潔劑可能會損壞控制面板上的打印。

洗滌劑投放盒

定期清潔，每年至少清潔三到四次，以防止洗衣液殘留於洗滌劑盒內：

按下洗滌劑投放盒拆除鍵  以取下洗滌劑投放盒。少量的水會殘留在盒子中，因此您應該將其直立放置。用流水清洗盒子。您也可以取下投放盒背面的虹吸管蓋以進行清潔。

裝回投放盒中的虹吸管蓋（如果已卸下），將投放盒的底部卡在機門內側對應的開口中，然後將投放盒推向機門直至其鎖定到位，從而重新安裝投放盒。**請確保正確安裝洗滌劑投放盒。**

檢查進水管

定期檢查進水管有否變得脆弱和破裂。如果發現損壞，請聯絡售後服務或經銷商以購買新喉管作更換。取決於喉管類型：如果進水管有透明塗層，定期檢查顏色是否有局部變深。如果是，則軟管可能出現洩漏，應予以更換。

至於保險入水喉 （如果有的話）：

可檢查安全閥小窗口（見箭頭）。如果為紅色，則已經觸發了水閘功能，必須更換新的軟管。若要擰鬆軟管，請在擰鬆軟管時按下釋放按鈕（若有）。

清潔進水管中的網狀過濾器

定期檢查和清潔（每年至少兩次或三次）

關閉水龍頭，然後鬆開水龍頭上的進水管。清潔內部的網狀過濾器，然後將進水管擰回水龍頭上。此時，鬆開洗衣機後的進水軟管。用鉗子從洗衣機的接口上拉出網狀過濾器並進行清潔。重新安裝濾網，然後再次擰緊進水管。打開水龍頭，確保完美連接沒有漏水。

清潔排水泵 / 排出積水

洗衣機配有自動清潔泵。過濾器會收集鈕扣、硬幣、安全別針等遺留在衣物中的物品。如果您使用熱水洗滌程序，請等到水冷卻後再進行排水。請定期清潔過濾器，以免衣物清洗完畢後，水分由於過濾器阻塞而無法排淨。如果水無法排出，指示燈會亮起提示過濾器可能堵塞。

用硬幣打開過濾器蓋。將一個寬而扁平的容器放在過濾器下方，以收集排出來的水。逆時針緩慢轉動過濾器，直到水流出。讓水流，而無需卸下過濾器。容器裝滿後，順時針旋轉以關閉過濾器。清空容器。重複此過程，直到所有水都排乾為止。在過濾器下面放一塊棉布，讓它吸收剩餘的水。

然後逆時針旋轉將過濾器拆下。清潔過濾器（清除過濾器中的殘留物，並在流水下清洗）和過濾器室。確保泵葉輪（在過濾器後面的外殼中）沒有被阻塞。插入過濾器，然後關閉過濾器蓋：順時針方向旋轉將水過濾器重新插入。請確保將其盡完全插入。要測試過濾器的緊密度，可以將約1升的水倒入滾筒中，並檢查水是否從過濾器中流出。然後關閉過濾器蓋。

機蓋密封墊

定期檢查機蓋密封墊的狀況，並偶爾用濕布清潔它。

取出掉落在洗衣槽和洗衣桶之間物品

若物品意外掉入洗衣槽和洗衣桶之間，您可以利用可拆式衣物槳葉將物品取出。

1. 拔下洗衣機電源插頭，從洗衣槽中取出衣物。
2. 關上洗衣槽扣，並將洗衣槽轉動半圈（圖a）。
3. 使用螺絲批一邊按住塑膠部分的末端，一邊將槳葉從左至右滑動（圖b,c），槳葉會脫出並掉入洗衣槽中。
4. 再次打開洗衣槽，此時您可以從洗衣槽槳葉的孔中取出物品。
5. 將衣物槳葉重新安裝於洗衣槽內：將槳葉的塑膠末端對應地放入洗衣槽右邊的孔上（圖d），然後從右至左滑動衣物槳葉直至槳葉完全卡在扣上。
6. 再次關閉洗衣槽門扣，轉動洗衣槽半圈並檢查槳葉的所有固定點是否到位。
7. 重新插回洗衣機電源插頭。

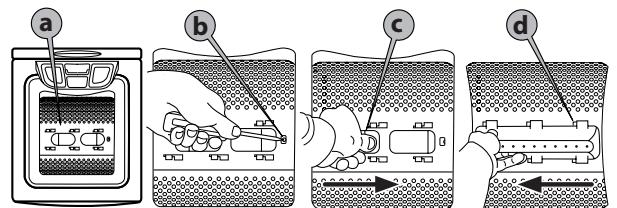

搬運及處理

拔出電源插頭，然後關閉水龍頭。從水龍頭上斷開進水管，然後從排水口處拆下排水管。清除喉管和洗衣機的所有殘餘水，並固定軟管，以免在運輸過程中損壞軟管。為便於移動機器，請用手一點一點拉下位於底部前部的滾輪拉桿（如果適用於您的機型）。用腳將洗衣機拉出至目標位置。停定後將滾輪拉桿推回原來的位置並固定。重新安裝運輸支架。如要卸下運輸螺栓，請按照《安裝指引》中有關卸下運輸螺栓的說明以反向順序進行操作。

故障排除指南

由於某些原因，洗衣機有時可能無法正常工作。建議在致電售後服務之前，使用以下列表檢查是否可以解決問題。

問題：	可能原因/解決方案：
洗衣機無法開機和/或程序無法啟動	<ul style="list-style-type: none"> 插頭未插入電源插座，或接觸不良。 發生了電源故障。 機門未正確關閉。 啟動了「童鎖」選項。  3 sec 在程序開始之前或程序結束之後，洗衣機會自動關閉以節省能源。要打開洗衣機，請先將程序選擇器轉到“Off/O”，然後再將其轉到所需的程序。
沒有開始洗衣程序	<ul style="list-style-type: none"> 尚未按下「開始/暫停」按鈕。  水龍頭未打開。 啟動了「預備校開機時間」選項。
洗衣機在程序執行期間停止，而且「開始/暫停」指示燈閃爍	<ul style="list-style-type: none"> 啟動了「延遲脫水」選項。 程序已更改-重新選擇所需的程序，然後按下「開始/暫停」按鈕。 
機身震動	<ul style="list-style-type: none"> 洗衣機未有水平擺放。 運輸螺栓尚未卸下；在使用洗衣機之前，必須先卸下運輸螺栓。
最終脫水效果不理想 程序結束後，「脫水」/「轉速」指示燈閃爍 - 取決於型號	<ul style="list-style-type: none"> 在脫水過程中衣物負載的不平衡會影響脫水效果，所以衣物仍然很濕。失衡的原因可能是：洗衣量少（僅由很少量但體積較大或吸水度高的衣物組成，例如毛巾），或較大/較重的衣物。 盡可能避免衣物量過少。 將「脫水轉速」調校至最低。
出現錯誤代碼（例如F-02, F-...） 「檢修」指示燈  亮起	<ul style="list-style-type: none"> 關閉洗衣機，從插座上拔下插頭，等待大約1分鐘，然後再將其重新啟動。 如果問題仍然存在，請致電售後服務。
亮起「清潔排水泵」指示燈 	<ul style="list-style-type: none"> 剩餘水未排清。 清潔過濾器
亮起「水龍頭關閉」指示燈 	<ul style="list-style-type: none"> 設備無水供應或供水不足。
亮起「過量洗衣劑」指示燈 	<ul style="list-style-type: none"> 如果您使用了過多的清潔劑，該符號將在程序結尾亮起。 形成太多的泡沫。 清潔劑與洗衣機不兼容（必須帶有「用於洗衣機」\「用於手洗和洗衣機」之類的字眼）。

安全說明

重要事項：請閱讀並遵循

使用洗衣機前請先細閱產品安全指引。請妥善保存此產品安全指引及使用說明作將來參考。本手冊和洗衣機本身提供重要的安全警告，請按需要隨時讀取及查察。不當的使用及不當的操作可能會導致的風險，製造商將不負任何責任。

⚠ 除非得到持續監視，否則幼兒(0-3歲)和兒童(3-8歲)應遠離洗衣機。洗衣機可由8歲以上之兒童及身體、感官或精神障礙或經驗知識不足的人士操作，前提是此等人士已接受洗衣機的安全指導及指引，且瞭解使用洗衣機的相關危險。

兒童不可胡亂玩弄洗衣機。未經指導，兒童不可進行洗衣機的清潔及保養工作。

切勿強行打開機門或以它作為踏板使用。

允許使用

⚠ 注意：此洗衣機不能透過外部控制器或遙控裝置進行操作。

⚠ 此洗衣機設計只適用於家居或下列之類似環境：如一般商店、辦公室及其他工作環境的職員專用廚房；農莊；供入住酒店、汽車旅館及其他住宅式旅店之顧客使用；提供簡單住宿及早餐服務之旅舍。

⚠ 請確保負載不超過最大洗衣量。(請參閱程序表中的指示)。

⚠ 洗衣機禁止作為商業用途。洗衣機不適合戶外使用。

⚠ 切勿使用任何溶劑(如鬆節油、汽油等)、含有溶劑、去污粉、玻璃或通用清潔劑、易燃液體洗滌劑；請勿以洗衣機清洗經溶劑或易燃液體處理過的衣物。

安裝

⚠ 此洗衣機建議由兩個或更多的人進行安裝處理，避免受傷風險。使用防護手套來執行所有拆封和安裝操作，避免割傷風險。

如果要在洗衣機頂部放置乾衣機，請首先聯繫我們的售後服務中心或您的經銷商，以確認是否可行。只允許使用我們的售後服務中心或您的經銷商提供的專業疊裝工具將乾衣機固定在洗衣機上。

⚠ 請勿提拉頂板來移動洗衣機。

⚠ 安裝，包括供水(如有任何接駁電線)，必須由合資格的技術人員按照製造商的說明和本地標準安全法規進行維修。除非在用戶手冊特別聲明，切勿維修或更換任何洗衣機的部件。兒童應遠離洗衣機安裝地點。拆開洗衣機後，確認它沒有在運輸過程中損壞。在出現問題時，請聯絡經銷商或售後服務中心。當完成安裝後，包裝棄掉的材料(如塑膠、發泡膠件等)，應置於幼童無法取得的地方，避免意外的風險。此洗衣機進行安裝前，必先斷開它的電源連接避免觸電危險。進行安裝時，確保洗衣機電源線沒有損壞，避免火災或觸電危險。只有當安裝步驟完成後才可啟動洗衣機。

⚠ 不要在極端的情況下安裝洗衣機，如：通風不良，溫度低於5°C或高於35°C。

⚠ 確保洗衣機的四隻腳穩固坐落在地面上，如需，可作調整，並檢查洗衣機是否完全處於水平位置(利用水平尺量度)。

⚠ 如果是木地板或所謂的「浮隔地板」，(例如某些鑲木或層壓地板)，請將機器放在在至少寬/深為60x60厘米以及厚度至少3厘米的一塊夾板上。

⚠ 根據本地供水公司的法規將進水喉管連接到水龍頭上。

⚠ 設計只能使用冷水的型號：切勿連接有熱水供應的水龍頭上。

⚠ 對於帶有熱水供水的型號：熱水進水的溫度絕對不能超過60°C。

⚠ 本洗衣機用運輸螺栓作固定，以防止運輸途中對其內部造成任何損壞。使用機器前必須拆除運輸螺栓。然後，請使用4個附帶的塑膠蓋把開口蓋。

⚠ 安裝完成後等待數小時使其恢復適合室內的環境，才可開始使用。

⚠ 確保地毯或其他材料不會阻塞洗衣機底部的通風孔(如您的型號適用)。

⚠ 必須使用新水喉將洗衣機連接到水源。用過的水喉絕對不能重新使用。

⚠ 水壓必須於0.1 -1 MPa內。

電器警告

⚠ 插座必須能夠拔掉，以切斷電源，或安裝設有開關鍵的插座及按照本地的電器安全標準法連接地線。

⚠ 請切使用接駁電線或多頭插座，安裝後電線部份不可被使用者易於接觸。手濕或赤腳接觸到水時請勿使用本產品。若本產品的電源線或插頭有損壞，不能正常運作，或受損，請勿操作。

⚠ 如果電源線損壞，必須根據相同產品更換電源線。電源線只能由符合製造商指導和現行的安全法規合格的技術人員更換以避免觸電的危險。

清潔和保養

⚠ 注意：執行任何維修或清潔操作之前，請先關閉及拔下電源插頭。

為避免人身傷害的危險，請使用防護手套（有割傷的危險）和安全鞋（有挫傷的危險）；確保由兩個人來處理（減少負荷）；切勿使用蒸汽清潔設備（電擊危險）。

不經製造商的非專業維修可能會導致健康和 safety 風險，因此製造商不承擔任何責任。

由非專業維修引起的任何缺陷或損壞均不在保養範圍之內。

處理包裝物料

包裝材料完全可回收，並設有可回收標誌 ：

包裝的各個部分必須根據當前本地廢品處理法規進行處理。

廢棄家用電器

必須根據當前本地廢品處理法規進行處理。有關處理、修復和回收本產品的詳細資訊，請聯繫售後服務中心、家庭廢品處理服務中心或您購買本產品的商店。

本洗衣機依照有關廢棄電器和電子設備(WEEE)的歐盟標準2012/19/EU標示。確保以正確的方式廢棄本產品，可避免因不當的廢棄處理方式而對環境和人體健康造成潛在的負面影響。

這符號  表示此機器不能作為家庭廢品處理。應將它交給回收電器和電子設備的適用收集點。

安裝指引

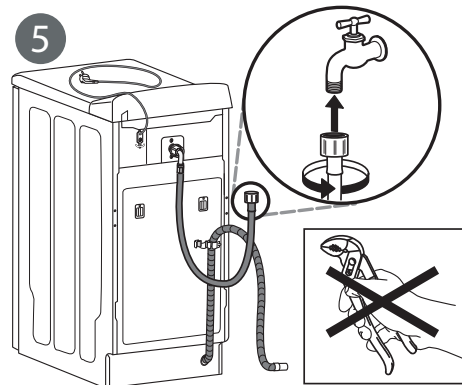
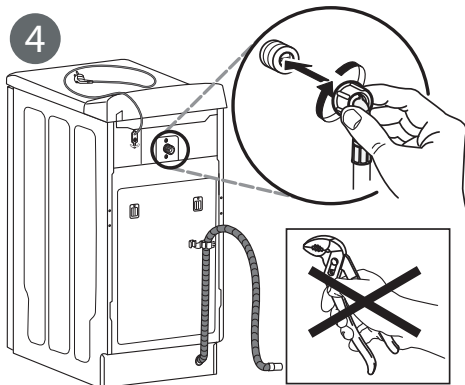
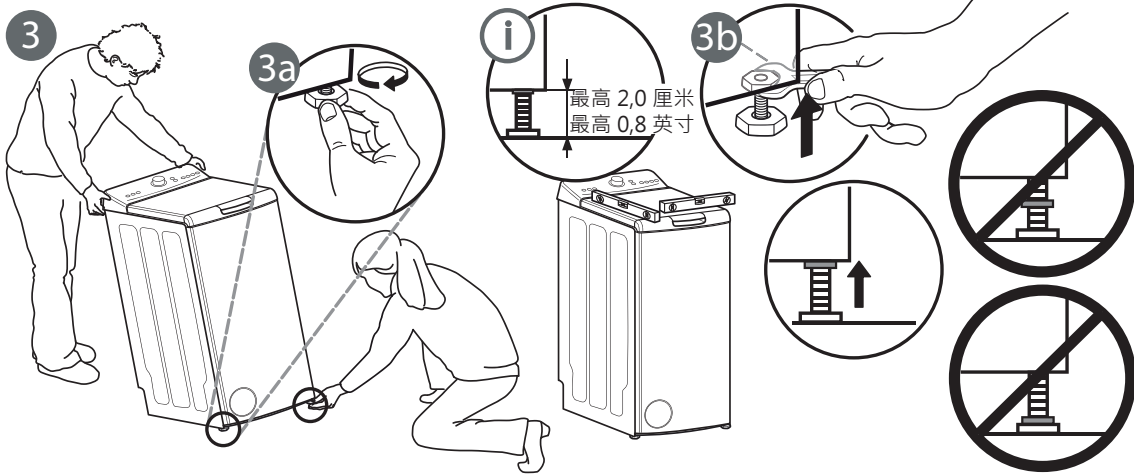
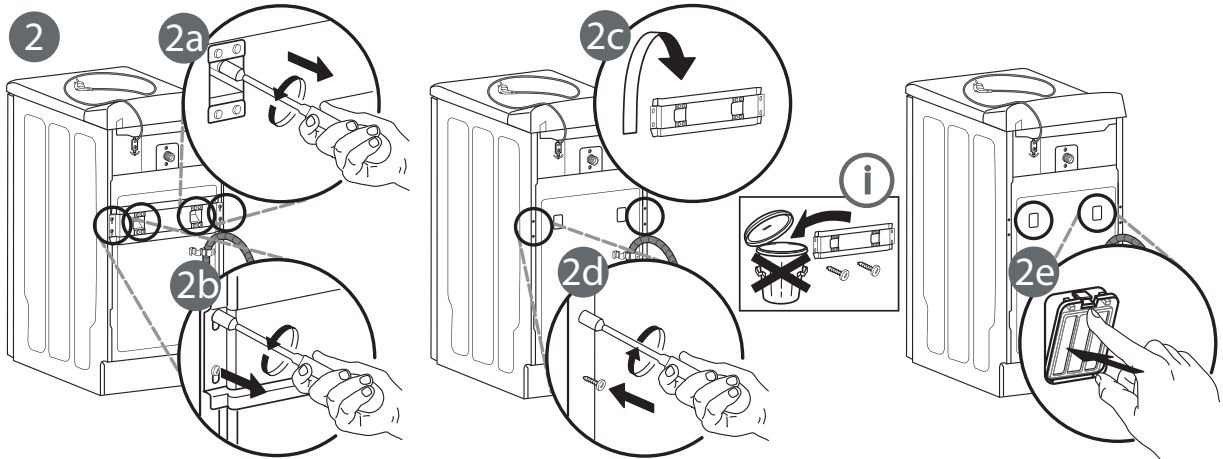
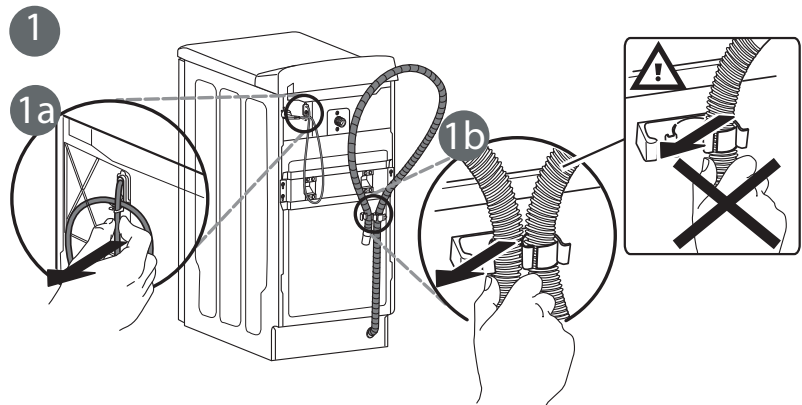

6

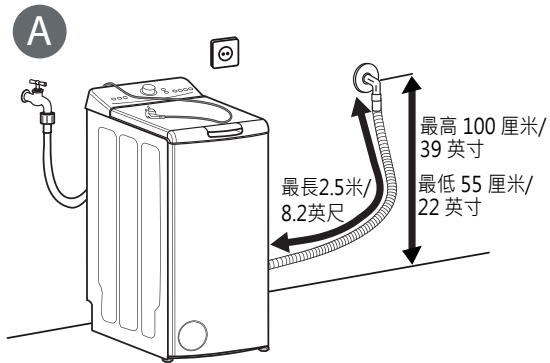

7

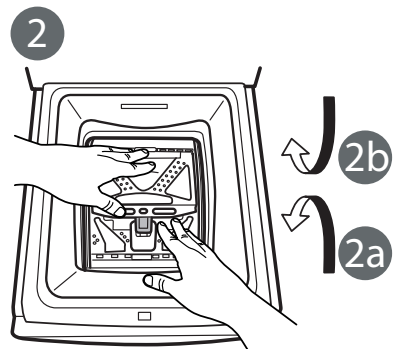
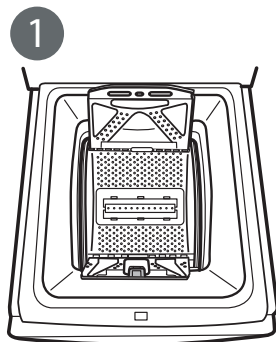
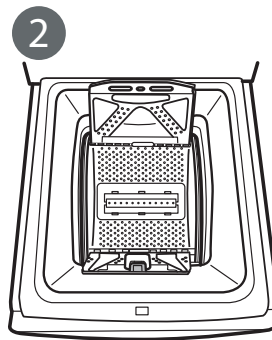
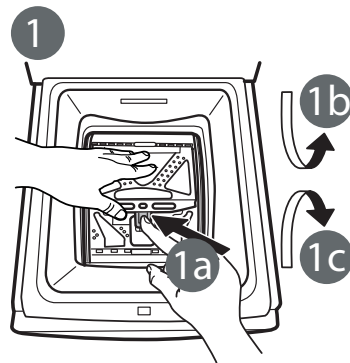
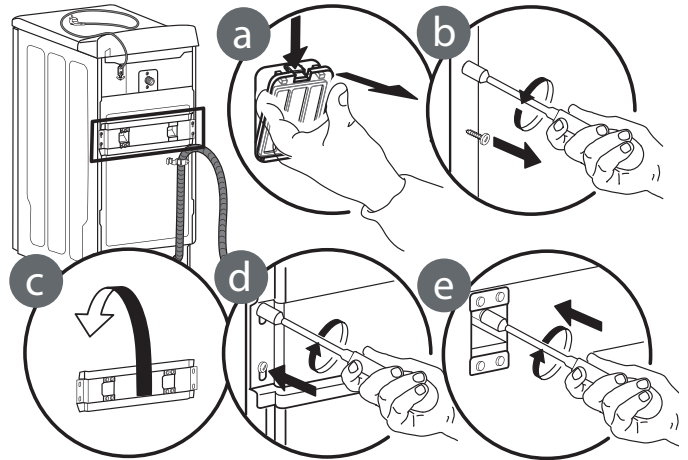
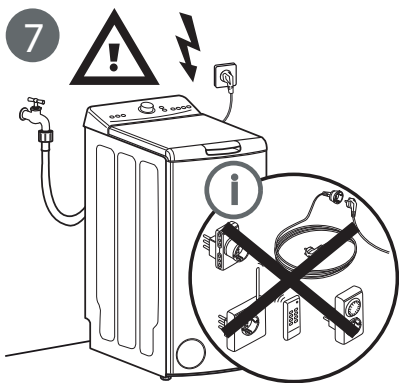

Register your product online 網上登記新產品保養

For Singapore Warranty, please scan QR code or visit below website:



<https://www.whirlpool.com.sg/>

For Hong Kong Warranty 香港地區保養

Save the planet and register your product warranty online!
Enjoy extra 1-month free warranty upon online registration.
「惠」環保出力，減少用紙！於網上登記產品更可獲額外多一個月保養。



<https://rebrand.ly/WPwarranty>



Whirlpool® Registered trademark/TM Trademark of Whirlpool group of companies
All rights reserved



Whirlpool® 註冊商標/惠而浦集團的TM商標
版權所有 翻印必究



Whirlpool