

DAILY REFERENCE GUIDE



THANK YOU FOR BUYING A WHIRLPOOL PRODUCT.
In order to receive a more complete assistance, please register your appliance on: www.whirlpool.eu/register



You can download the Safety Instructions and the User Manual, by visiting our website docs.whirlpool.eu and following the Instructions on the back of this booklet.

Before using the appliance carefully read Safety Instructions.

PRODUCT DESCRIPTION

APPLIANCE

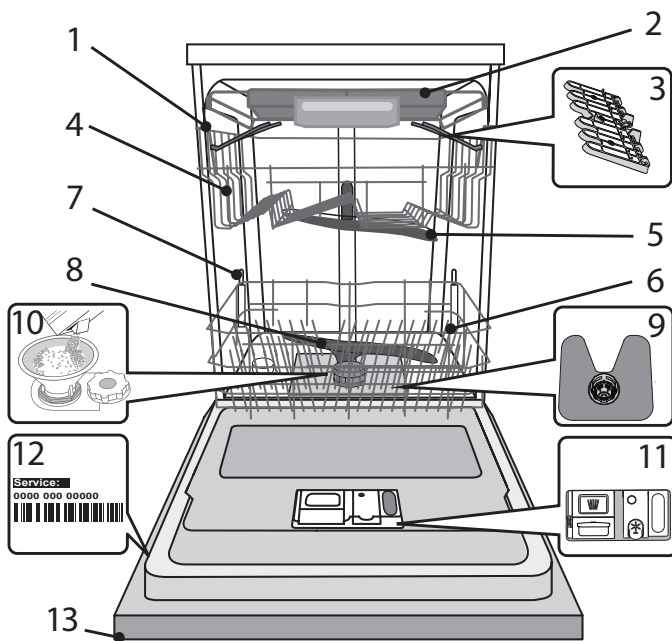

1. Upper rack
2. Cutlery rack
3. Foldable flaps
4. Upper rack height adjuster
5. Upper spray arm
6. Lower rack
7. Power Clean® support
8. Lower spray arm
9. Filter Assembly
10. Salt reservoir
11. Detergent and Rinse Aid dispensers
12. Rating plate
13. Control panel

CONTROL PANEL

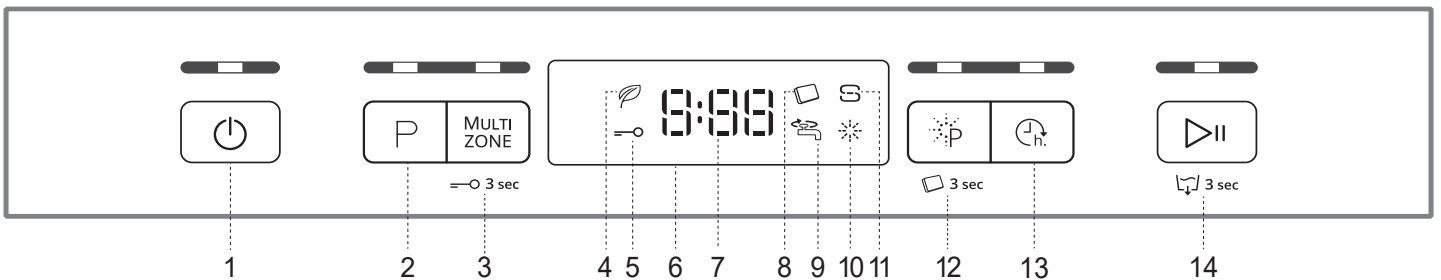

- | | |
|---|--|
| <ol style="list-style-type: none"> 1. On-Off/Reset button with indicator light 2. Program selection button with indicator light 3. Multizone button with indicator light / Key lock 4. Eco program indicator light 5. Key lock indicator light 6. Display 7. Program number and remaining time indicator | <ol style="list-style-type: none"> 8. Tablet (Tab) indicator light 9. Closed water tap indicator light 10. Rinse Aid refill indicator light 11. Salt refill indicator light 12. Power Clean® button with indicator light / Tablet (Tab) 13. Delay button with indicator light 14. Start/Pause button with indicator light / Drain out |
|---|--|

FIRST TIME USE

SALT, RINSE AID AND DETERGENT

ADVICE REGARDING THE FIRST TIME USE

After installation, remove the stoppers from the racks and the retaining elastic elements from the upper rack.

FILLING THE SALT RESERVOIR

The use of salt prevents the formation of LIMESCALE on the dishes and on the machine's functional components.

- It is mandatory that **THE SALT RESERVOIR BE NEVER EMPTY.**
- It is important to set the water hardness.

The salt reservoir is located in the lower part of the dishwasher (see *PRODUCT DESCRIPTION*) and must be filled when the **SALT REFILL indicator light**  in the control panel is lit.

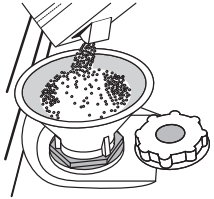

1. Remove the lower rack and unscrew the reservoir cap (anticlockwise).
2. **Only the first time you do this: fill the salt reservoir with water.**
3. Position the funnel (see figure) and fill the salt reservoir right up to its edge (approximately 1 kg); it is not unusual for a little water to leak out.
4. Remove the funnel and wipe any salt residue away from the opening.

Make sure the cap is screwed on tightly, so that no detergent can get into the container during the wash program (this could damage the water softener beyond repair).

Whenever you need to add salt, it is mandatory to complete the procedure before the beginning of the washing cycle to avoid corrosion.

SETTING THE WATER HARDNESS

To allow the water softener to work in a perfect way, it is essential that the water hardness setting is based on the actual water hardness in your house. This information can be obtained from your local water supplier. The factory sets the default value for the water hardness

- Switch on the appliance by pressing the **ON/OFF** button.
- Switch off the appliance by pressing the **ON/OFF** button.
- Hold down button **START/Pause** for 5 seconds, until you hear a beep.
- Switch on the appliance by pressing the **ON/OFF** button.
- The current selection level number and the salt indicator light both flash.
- Press button **P** to select the desired hardness level (see *WATER HARDNESS TABLE*).

Water Hardness Table				
Level		°dH German degrees	°fH French degrees	°Clark English degrees
1	Soft	0 - 6	0 - 10	0 - 7
2	Medium	7 - 11	11 - 20	8 - 14
3	Average	12 - 16	21 - 29	15 - 20
4	Hard	17 - 34	30 - 60	21 - 42
5	Very hard	35 - 50	61 - 90	43 - 62

- Switch off the appliance by pressing the **ON/OFF** button.

Setting is complete!

As soon as this procedure is complete, run a program without loading.

Only use salt that has been specifically designed for dishwashers.

After the salt has been poured into the machine, the SALT REFILL indicator light switches off.

If the salt container is not filled, the water softener and the heating element may be damaged as a result of limescale accumulation.

Using of Salt is recommended with any type of dishwasher detergent.

FILLING THE RINSE AID DISPENSER

Rinse aid makes dish DRYING easier. The rinse aid dispenser **A** should be filled when the **RINSE AID REFILL**  indicator light in the control panel is lit.

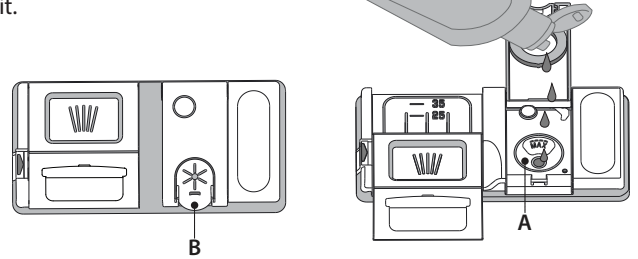

1. Open the dispenser **B** by pressing and pulling up the tab on the lid.
 2. Pour in the rinse aid (max.110 ml), making sure it does not overflow from the dispenser. If this happens, clean the spill immediately with a dry cloth.
 3. Press the lid down until you hear a click to close it.
- NEVER pour the rinse aid directly into the appliance tub.**

ADJUSTING THE DOSAGE OF RINSE AID

If you are not completely satisfied with the drying results, you can adjust the quantity of rinse aid used.

- Switch the dishwasher on using the **ON/OFF** button.
- Switch it off using the **ON/OFF** button.
- Press button **START/Pause** three times - a beep will be heard.
- Switch it on using the **ON/OFF** button.
- The current selection level number and rinse aid indicator light flash.
- Press button **P** to select the level of rinse aid quantity to be supplied.
- Switch it off using the **ON/OFF** button

Setting is complete!

If the rinse aid level is set to 1 (ECO), no rinse aid will be supplied.

The LOW RINSE AID indicator light will not be lit if you run out of rinse aid. A maximum of 5 levels can be set according to the dishwasher model. The factory setting is specific to the model, please follow instruction above to check this for your machine.

- If you see bluish streaks on the dishes, set a low number (2-3).
- If there are drops of water or limescale marks on the dishes, set a mid-range number (4-5).

FILLING THE DETERGENT DISPENSER

To open the detergent dispenser use the opening device **C**. Introduce the detergent into the dry dispenser **D** only. Place the amount of detergent for pre-washing directly inside the tub.

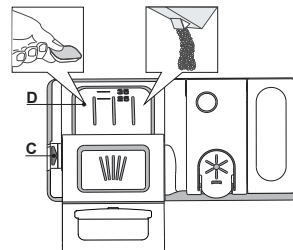















1. When measuring out the detergent refer to the mentioned earlier information to add the proper quantity. Inside the dispenser **D** there are indications to help the detergent dosing.
2. Remove detergent residues from the edges of the dispenser and close the cover until it clicks.
3. Close the lid of the detergent dispenser by pulling it up until the closing device is secured in place.

The detergent dispenser automatically opens up at the right time according to the program.

If all-in-one detergents are used, we recommend using the **TABLET** button, because it adjusts the program so that the best washing and drying results are always achieved.

Usage of detergent not designed for dishwashers may cause malfunction or damage to the appliance.

PROGRAMS TABLE

Program	Drying phase	NaturalDry	Available options *)	Duration of wash program (h:min)**)	Water consumption (litres/cycle)	Energy consumption (kWh/cycle)	
1. Eco	ECO 50°	✓	✓		3:10	9.5	0.85
2. 6th Sense®	 50-60°	✓	✓	MULTI ZONE 	1:25 - 3:00	7.0 - 14.0	0.90 - 1.40
3. Intensive	 65°	✓	✓	MULTI ZONE 	2:50	16.0	1.60
4. Fast Wash&Dry	 50°	✓	✓	MULTI ZONE 	1:25	11.5	1.10
5. Crystals	 45°	✓	✓	MULTI ZONE 	1:40	11.5	1.20
6. Rapid 30'	 50°	-	-	MULTI ZONE 	0:30	9.0	0.50
7. Silent	 50°	✓	✓		3:30	15.0	1.15
8. Pre-Wash	 -	-	-	MULTI ZONE 	0:12	4.5	0.01

ECO program data is measured under laboratory conditions according to European Standard EN 60436:2020.

Note for Test Laboratories:

For information on comparative EN testing conditions, please send an email to the following address: dw_test_support@whirlpool.com

Pre-treatment of the dishes is not needed before any of the programs.

*) Not all options can be used simultaneously.

***) Values given for programs other than the program Eco are indicative only. The actual time may vary depending on many factors such as temperature and pressure of the incoming water, room temperature, amount of detergent, quantity and type of load, load balancing, additional selected options and sensor calibration. The sensor calibration can increase program duration up to 20 min.

PROGRAMS DESCRIPTION

Instructions on wash cycle selection.

1 ECO

Eco programme is suitable to clean normally soiled tableware, that for this use, it is the most efficient programme in terms of its combined energy and water consumption, and that it is used to assess compliance with the EU Ecodesign legislation.

2 6th SENSE®

For normally soiled dishes with dried food residues. Senses the level of soiling on the dishes and adjusts the program accordingly. When the sensor is detecting the soil level an animation appears in the display and the cycle duration is updated.

3 INTENSIVE

Program recommended for heavily soiled crockery, especially suitable for pans and saucepans (not to be used for delicate items).

4 FAST WASH&DRY

Normally soiled crockery. Everyday cycle, that ensures optimal cleaning performance in shorter time.

5 CRYSTALS

Program for delicate items, which are more sensitive to high temperatures, for example glasses and cups.

6 RAPID 30'

Program to be used for half load of lightly-soiled dishes with no dried food residues. Does not have drying phase.

7 SILENT

Suitable for night-time operation of the appliance. Ensures optimal cleaning and drying performance with the lowest noise emission.

8 PRE-WASH

Use to refresh crockery planned to be washed later. No detergent to be used with this program.

Notes:

Please note that cycle Rapid 30' is dedicated for lightly soiled dishes.

OPTIONS AND FUNCTIONS

OPTIONS can be selected directly by pressing the corresponding button (see CONTROL PANEL).

If an option is not compatible with the selected program see PROGRAMS TABLE, the corresponding LED flashes rapidly 3 times and beeps will sound. The option will not be enabled.

MULTI ZONE MULTIZONE

If there are not many dishes to be washed, a half loading may be used in order to save water, electricity and detergent. Select the program and then press the MULTIZONE button: the indicator over the button lights up and the symbol of the chosen rack will appear on the display. By default the appliance washes dishes in all racks.

To wash only the specific rack, press this button repeatedly:

 shown on the display (only lower rack)

 shown on the display (only upper rack)

 shown on the display (only cutlery rack)

 shown on the display (option is OFF and the appliance will wash dishes in all racks).

Remember to load the upper or lower rack only, and to reduce the amount of detergent accordingly.

If upper rack is removed, please apply detergent directly to tub instead of detergent dispenser.

KEYLOCK

A long press (for 3 seconds) of MULTIZONE button, will activate the KEYLOCK function. The KEYLOCK function will block the control panel except the ON/OFF button.

To deactivate the KEYLOCK, long press again.

WATER TAP CLOSED – Alarm

Flashes when there is no inlet water or water tap is closed.

POWER CLEAN®

Thanks to the additional power jets this option provides a more intensive and powerful wash in the lower rack, in the specific area. This option is recommended for washing pots and casseroles. Press this button to activate POWER CLEAN® (the indicator lights up).

TABLET

This setting allows you to optimize the performance of the program according to the type of detergent used.

A long press (for 3 seconds) of the POWER CLEAN® button, will activate the function (the corresponding symbol will light up) if you use combined detergents in tablet form (rinse aid, salt and detergent in 1 dose).

If you use powder or liquid detergent, this option should be off.

DELAY

The start of the program may be delayed for a period of time between **0:30** and **24** hours.

1. Select the program and any desired options. Press the DELAY button (repeatedly) to delay the start of the program. Adjustable from 0:30 to 24 hours. With each press of the button, the delay start increases by: 0:30 if selection below 4 hours, 1:00 if selection is below 12 hours, 4 hours if selection is above 12 hours. If 24 hours reached, and the button is pressed, the delayed start is deactivated.
2. Press the START/PAUSE button: the timer will begin counting down;
3. Once this time has elapsed, the indicator light switches off and the program begins automatically.

If at the time of the countdown the START/PAUSE button is pressed again the DELAY option is cancelled and the selected program starts automatically.

The Delay function cannot be set once a wash cycle has been started.

DRAIN OUT

To stop and cancel the active cycle, the Drain Out function can be used.

A long press of START/PAUSE button, will activate the DRAIN OUT function. The active program will be stopped and the water in the dishwasher will be drained out.

NaturalDry

NaturalDry is a convection drying system which automatically opens the door during/after drying phase to ensure exceptional drying performance every day. Door opens at the temperature that is safe to your kitchen furniture.

As additional steam protection, special designed protection foil is added together with the dishwasher (depending on the model type - can be the need to buy it). To see how to mount protection foil please refer to (INSTALLATION GUIDE).

NaturalDry functionality could be disabled by the user as follows:

- To DISABLE: Switch On, then switch Off. Keep the **P** button pressed for 5 sec., at the end of 5 sec the dishwasher plays a short beep. Switch On the machine, the display shows „oOF“.
- To ENABLE: Switch On, then switch Off the machine. Keep the **P** button pressed for 5 sec., at the end of 5 sec the dishwasher plays a short beep. Switch On the machine, the display shows „oOn“.

LOADING THE RACKS

CUTLERY RACK

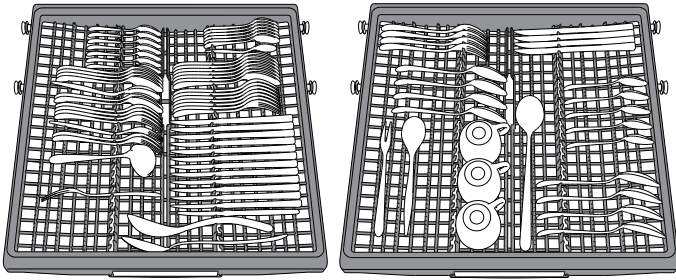

The third rack was designed to house the cutlery. Arrange the cutlery as shown in the figure. A separate arrangement of the cutlery makes collection easier after washing and improves washing and drying performance.

Knives and other utensils with sharp edges must be positioned with the blades facing downwards.

The geometry of the rack makes it possible to place such small items as coffee cups in the area in the middle.

UPPER RACK

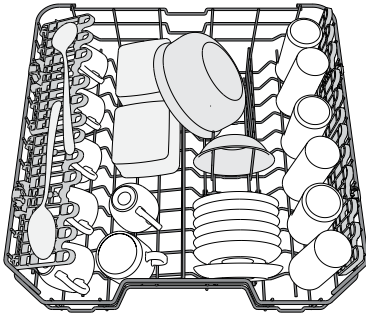

Load delicate and light dishes: glasses, cups, saucers, low salad bowls.

(loading example for the upper rack)

ADJUSTING THE HEIGHT OF THE UPPER RACK

The height of the upper rack can be adjusted: high position to place bulky crockery in the lower basket and low position to make the most of the tip-up supports by creating more space upwards and avoid collision with the items loaded into lower rack.

The upper rack is equipped with a **Upper Rack height adjuster** (see figure), without pressing the levers, lift it up by simply holding the rack sides, as soon as the rack is stable in its upper position. To restore to the lower position, press the levers **A** at the sides of the rack and move the basket downwards.

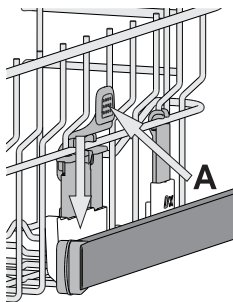

We strongly recommend that you do not adjust the height of the rack when it is loaded.

NEVER raise or lower the basket on one side only.

FOLDABLE FLAPS WITH ADJUSTABLE POSITION

The side foldable flaps can be fold or unfold to optimize the arrangement of crockery inside the rack. Wine glasses can be placed safely in the foldable flaps by inserting the stem of each glass into the corresponding slots.

Depending on the model:

- to unfold the flaps there is needed to slide it up and rotate or release it from the snaps and pull it down.
- to fold the flaps there is needed to rotate it and slide flaps down or pull it up and attach flaps to the snaps.

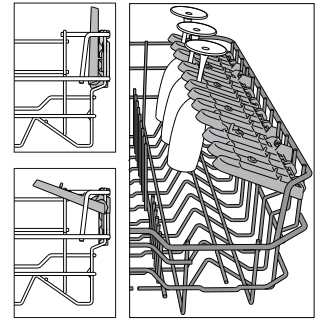

LOWER RACK

For pots, lids, plates, salad bowls, cutlery etc. Large plates and lids should ideally be placed at the sides to avoid interferences with the spray arm.

The lower rack has tip-up supports which can be used in a vertical position when arranging plates or in a horizontal position (lower) to load pans and salad bowls easily.

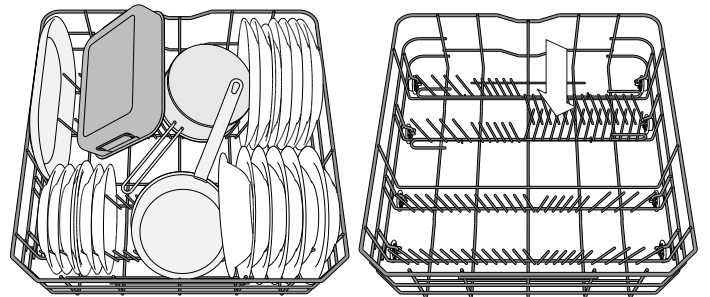

(loading example for the lower rack)

POWER CLEAN®

Power Clean® uses the special water jets in the rear of cavity to wash more intensively the high dirty items. The lower rack has a Space Zone, a special pull-out support in the rear of the rack that can be used to support frying pans or baking pans in upright position, thus taking up less space.

Placing the pots/casseroles faced to the Power Clean® component please activate the **POWER CLEAN®** on the panel.

How to use Power Clean®:

1. Adjust the Power Clean® area **G** folding down the rear plate holders to load pots.
2. Load pots and casseroles inclined vertically in Power Clean® area. Pots have to be inclined towards the power water jets.

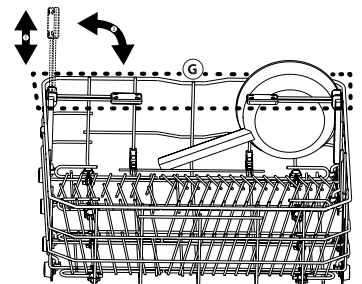
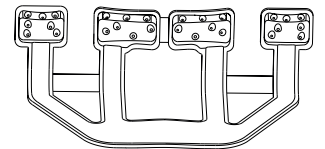

DAILY USE

1. CHECK WATER CONNECTION

Check that the dishwasher is connected to the water supply and that the tap is open.

2. SWITCH ON THE DISHWASHER

Press the **ON/OFF** button.

3. LOAD THE RACKS

(see *LOADING THE RACKS*).

4. FILLING THE DETERGENT DISPENSER

5. CHOOSE THE PROGRAM AND CUSTOMISE THE CYCLE

Select the most appropriate program in accordance with the type of crockery and its soiling level (see *PROGRAMS DESCRIPTION*) by pressing the **P** button.

Select the desired options (see *OPTIONS AND FUNCTIONS*).

6. START

Start the wash cycle by pressing the **START/Pause** button. When the program starts you hear a beep.

7. END OF WASH CYCLE

The end of the wash cycle is indicated by beeps and the display shows **END**. Open the door and switch off the appliance by pressing the **ON/OFF** button.

Wait for a few minutes before removing the crockery - to avoid burns. Unload the racks, beginning with the lower one.

The machine will switch off automatically during certain extended periods of inactivity, in order to minimise electricity consumption. If the crockery is only lightly soiled or if it has been rinsed with water before being placed in the dishwasher, reduce the amount of detergent used accordingly.

MODIFYING A RUNNING PROGRAM

If a wrong program was selected, it is possible to change it, provided that it has only just begun: press and hold the **ON/OFF** button, the machine will switch off. Switch the machine back on using the **ON/OFF** button and select the new wash cycle and any desired options; start the cycle by pressing the **START/PAUSE** button.

ADDING EXTRA CROCKERY

Without switching off the machine, open the door (**be ware of HOT steam!**) and place the crockery inside the dishwasher. Close the door and press the **START/Pause** button the cycle will begin from the point at which it was interrupted.

ACCIDENTAL INTERRUPTIONS

If the door is opened during the wash cycle, or if there is a power cut, the cycle stops. Once the door has been closed or the electricity supply is restored, to start again the cycle from where it was interrupted, press the **START/Pause** button.

To disable the **DEMO MODE** the following actions must be carried out in sequence, without breaks. Switch the machine ON and then switch it OFF again. Press the DELAY button until the buzzer is heard. Switch the machine on again. The “**dOF**” indicator flashes and then turns OFF.

ADVICE AND TIPS

TIPS

Before loading the baskets, remove all food residues from the crockery and empty the glasses. You do not need to rinse beforehand under running water.

Arrange the crockery so that it is held in place firmly and does not tip over; and arrange the containers with the openings facing downwards and the concave/convex parts placed obliquely, thus allowing the water to reach every surface and flow freely.

Warning: lids, handles, trays and frying pans do not prevent the sprayer arms from rotating.

Place any small items in the cutlery basket.

Very soiled dishes and pans should be placed in the lower basket because in this sector the water sprays are stronger and allow a higher washing performance.

After loading the appliance, make sure that the sprayer arms can rotate freely.

UNSUITABLE CROCKERY

- Wooden crockery and cutlery.
- Delicate decorated glasses, artistic handicraft and antique crockery. Their decorations are not resistant.
- Parts in synthetic material which do not withstand high temperatures.
- Copper and tin crockery.
- Crockery soiled with ash, wax, lubricating grease or ink.

The colours of glass decorations and aluminium/silver pieces can change and fade during the washing process. Some types of glass (e.g. crystal objects) can become opaque after a number of wash cycles too.

DAMAGE TO GLASS AND CROCKERY

- Only use glasses and porcelain guaranteed by the manufacturer as dishwasher safe.
- Use a delicate detergent suitable for crockery
- Collect glasses and cutlery from the dishwasher as soon as the wash cycle is over.

TIPS ON ENERGY SAVING

- When the household dishwasher is used according to the manufacturer's instructions, **washing tableware in a dishwasher usually consumes less energy and water than hand dishwashing.**
- In order to maximize dishwasher efficiency it is recommended to **initiate the wash cycle once dishwasher is fully loaded.** Loading the household dishwasher up to the capacity indicated by the manufacturer will contribute to energy and water savings. Information on correct loading of tableware can be found in *LOADING THE RACKS* chapter.
- In case of partial loading it is recommended to use dedicated wash options if available (Half load/ Zone Wash, Multizone), filling up only selected racks. Incorrect loading or overloading the dishwasher may increase resources usage (such as water, energy and time, as well as increase noise level), reducing cleaning and drying performance.
- Manual pre-rinsing of tableware items leads to increased water and energy consumption and is not recommended.

HYGIENE

To avoid odour and sediment which can be accumulated in the dishwasher please **run a high temperature program at least one a month.** Use a tea spoon of detergent and run it without the loading to clean your appliance.

CARE AND MAINTENANCE

CLEANING THE FILTER ASSEMBLY

Regularly clean the filter assembly so that the filters do not clog and that the waste water flows away correctly.

Using dishwasher with clogged filters or foreign objects inside filtration system or sprayarms may cause unit malfunction resulting in lose of performance, noisy work or higher resources usage.

The filter assembly consists of three filters which remove food residues from the washing water and then recirculate the water.

The dishwasher must not be used without filters or if the filter is loose.

At least once per month or after each 30 cycles, check the filter assembly and if necessary clean it thoroughly under running water, using a non-metallic brush and following the instructions below:

1. Turn the cylindrical filter **A** in an anti-clockwise direction and pull it out (Fig 1).
2. Remove the cup filter **B** by exerting a slight pressure on the side flaps (Fig 2).
3. Slide out the stainless-steel plate filter **C** (Fig 3).
4. In case you find foreign objects (such as broken glass, porcelain, bones, fruit seeds etc.) **please remove them carefully**.
5. Inspect the trap and remove any food residues. **NEVER REMOVE** the wash-cycle pump protection (black detail) (Fig 4).

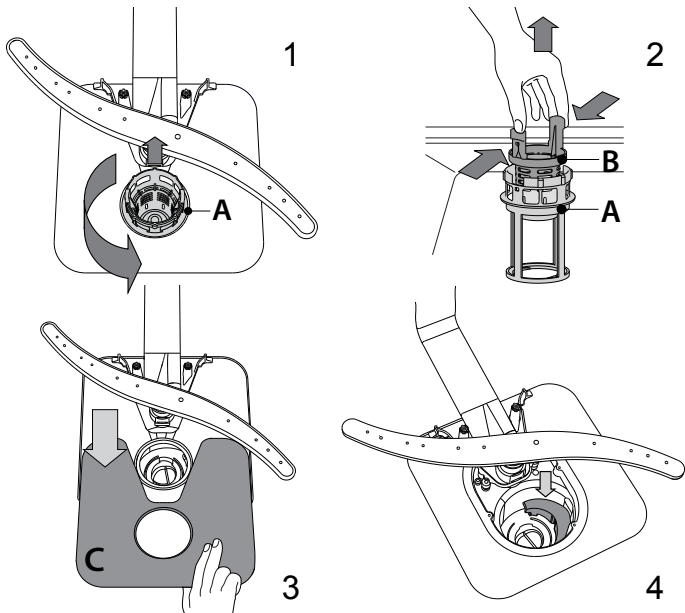

After cleaning the filters, re-place the filter assembly and fix it in position correctly; this is essential for maintaining the efficient operation of the dishwasher.

CLEANING THE WATER INLET HOSE

If the water hoses are new or have not been used for an extended period of time, let the water run to make sure it is clear and free of impurities before performing the necessary connections. If this precaution is not taken, the water inlet could become blocked and damage the dishwasher.

CLEANING THE SPRAY ARMS

On occasions, food residue may become encrusted onto the spray arms and block the holes used to spray the water. It is therefore recommended that you check the arms from time to time and clean them with a small non-metallic brush.

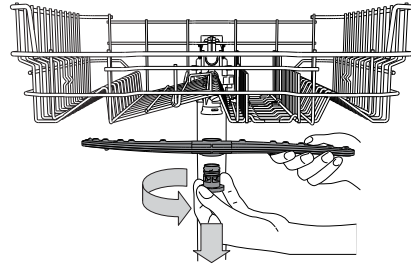

To remove the upper spray arm, turn the plastic locking ring in an anti-clockwise direction. The upper spray arm should be replaced so that the side with the greater number of holes is facing upwards.

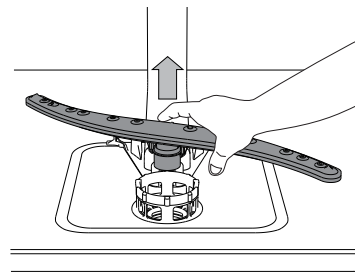

The lower spray arm may be removed by pulling it upwards.

WATER SOFTENING SYSTEM

Water softener automatically reduces water hardness, consequently preventing scale buildup on heater, contributing also to better cleaning efficiency.

This system regenerates itself with salt, therefore it is required to refill salt container when empty.



Frequency of regeneration depends on water hardness level setting - regeneration takes place once per **6** Eco cycles with water hardness level set to **3**.

Regeneration process starts in final rinse and finishes in drying phase, before cycle ends.

- Single regeneration consumes: ~3.5 L of water;
- Takes up to 5 additional minutes for the cycle;
- Consumes below 0.005 kWh of energy.

TROUBLESHOOTING

In case your dishwasher doesn't work properly, check if the problem can be solved by going through the following list. For other errors or issues please contact authorized After-sales Service which contact details can be found in the warranty booklet. The manufacturer ensures the availability of spare parts for at least 10 years after production date of this appliance.

PROBLEMS	POSSIBLE CAUSES	SOLUTIONS
 Salt indicator is lit	Salt reservoir is empty (after refill the salt indicator may remain lit for several wash cycles).	Refill reservoir with salt (for more information - see page 2). Adjust water hardness (see table, page 2).
 Rinse aid indicator is lit	Rinse aid dispenser is empty (after refill the rinse aid indicator may remain lit for several wash cycles).	Refill dispenser with rinse aid (for more information - see page 2).
The dishwasher won't start or does not respond to commands.	The appliance has not been plugged in properly.	Insert the plug into the socket.
	Power outage.	For safety reasons, dishwasher will not restart automatically when power returns. Press the START/Pause button to resume the cycle.
	The dishwasher door is not closed. NaturalDry pin is not pulled in.	Vigorously push the door until you hear the "click".
	Cycle is interrupted by door opening for > 4 seconds.	Close the door and press START/Pause button.
The dishwasher won't drain. Display shows: F3 and both On/Off and START/Pause LEDs are blinking rapidly.	The wash cycle has not finished yet.	Wait until the wash cycle finishes.
	The drain hose is bent.	Check that the drain hose is not bent (see <i>INSTALLATION INSTRUCTION</i>).
	The sink drain pipe is blocked.	Clean the sink drain pipe.
	The filter is clogged up with food residues.	Clean the filter (see <i>CLEANING THE FILTER ASSEMBLY</i>).
The dishwasher makes excessive noise.	The dishes are rattling against each other.	Position the crockery correctly (see <i>LOADING THE RACKS</i>).
	An excessive amount of foam has been produced.	The detergent has not been measured out correctly or it is not suitable for use in dishwashers (see <i>FILLING THE DETERGENT DISPENSER</i>). Restart dishwasher by pressing the DRAIN button (see <i>OPTIONS AND FUNCTIONS</i>) and run new program without detergent.
The dishes are not clean.	The crockery has not been arranged properly.	Arrange the crockery correctly (see <i>LOADING THE RACKS</i>).
	The spray arms cannot rotate freely, being hindered by the dishes.	Arrange the crockery correctly (see <i>LOADING THE RACKS</i>).
	The wash cycle is too gentle.	Select an appropriate wash cycle (see <i>PROGRAMS TABLE</i>).
	An excessive amount of foam has been produced.	The detergent has not been measured out correctly or it is not suitable for use in dishwashers (see <i>FILLING THE DETERGENT DISPENSER</i>).
	The cap on the rinse aid compartment has not been shut correctly.	Make sure the cap of the rinse aid dispenser is closed.
	The filter is soiled or clogged.	Clean the filter assembly (see <i>CARE AND MAINTENANCE</i>).
The dishwasher does not fill the water. Display shows:  and F6 , both On/Off and START/Pause LEDs are blinking rapidly.	No water in the water supply or the tap is closed.	Make sure there is water in the water supply or the tap running.
	The inlet hose is bent.	Make sure the inlet hose is not bent (see <i>INSTALLATION</i>) reprogram the dishwasher and reboot.
	The sieve in the water inlet hose is clogged; it is necessary to clean it.	After having carried out the verification and cleaning, turn off and turn on the dishwasher and restart a new program.
Dishwasher finishes the cycle prematurely. Display shows: F15 and both On/Off and START/Pause LEDs are blinking rapidly.	Drain hose positioned too low or siphoning into home sewage system.	Check if end of drain hose is placed at correct height (see <i>INSTALLATION</i>). Check for siphoning into home sewage system, install air admittance valve if necessary.
	Air in water supply.	Check water supply for leaks or other issues letting air inside.



Policy and standard documentation and additional product information can be found by:

- Visiting our website docs.whirlpool.eu
- Using QR Code
- Alternatively, **contact our After-sales Service** (See phone number in the warranty booklet). When contacting our After-sales Service, please state the codes provided on your product's identification plate.

The model information can be retrieved using the QR-Code reported in the energy label. The label also includes the model identifier that can be used to consult the portal of the registry at <https://eprel.ec.europa.eu> (available only on certain models).

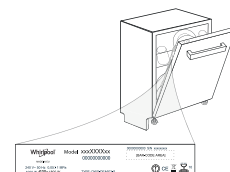

400011559496

07/2021 as - Xerox Fabriano



使用說明書



感謝您購買惠而浦產品
為了獲得更完善的服務，
請於 www.whirlpool.com.hk 註冊您的產品

使用洗碗碟機前請先細閱產品安全指引

產品介紹

產品結構

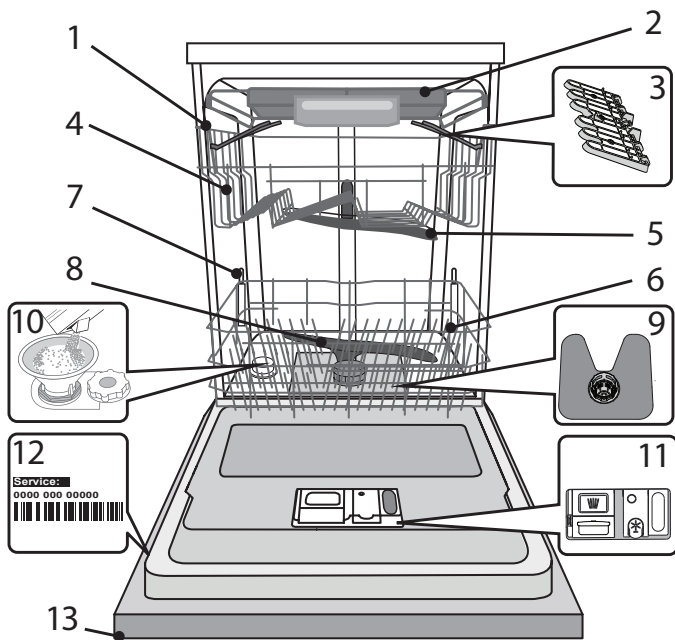

1. 上層餐具層架
2. 餐具層架
3. 可摺疊盛載器
4. 上層餐具層架高度調節器
5. 上層噴灑臂
6. 下層餐具層架
7. Power Clean® 裝置
8. 下層噴灑臂
9. 過濾器組件
10. 洗碗碟機專用軟水劑儲存器
11. 洗碗碟機專用清潔劑及吹乾劑儲存器
12. 銘牌
13. 控制面板

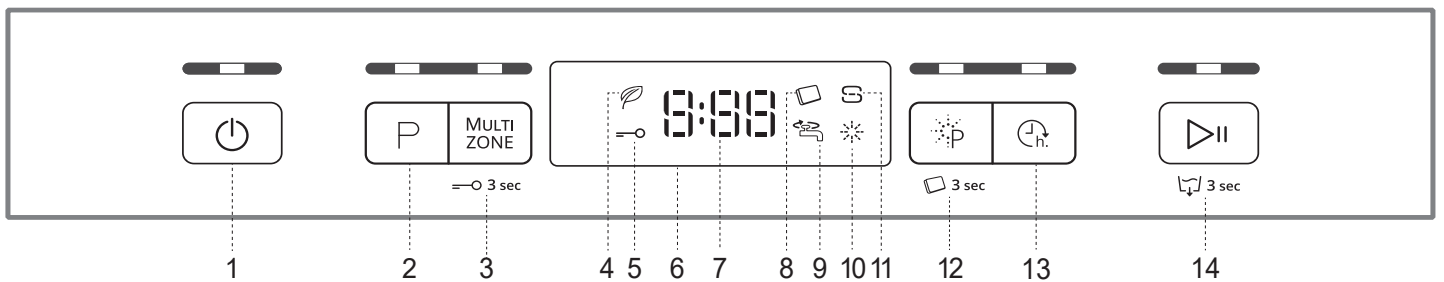

1. 電源「開/關/重設」鍵及指示燈
2. 「程序」鍵及指示燈
3. 「多區選擇」鍵及指示燈/ 控制面板安全鎖
4. 「省電洗」程序指示燈
5. 「兒童安全鎖」指示燈
6. 顯示屏
7. 「程序號碼」及「剩餘時間顯示」指示燈
8. 「洗碗碟機專用清潔片」指示燈
9. 「水龍頭關閉」指示燈
10. 「洗碗碟機專用吹乾劑注入提示」指示燈
11. 「洗碗碟機專用軟水劑注入提示」指示燈
12. 「高溫清洗/ 洗碗碟機專用清潔片」鍵及指示燈
13. 「預校開機時間」鍵及指示燈
14. 「啟動/暫停」鍵及指示燈/ 排水鍵

首次使用 洗碗碟機專用軟水劑、吹乾劑、清潔劑

首次使用的建議

安裝機件完畢後，首先將層架上的柱塞及上層層架的彈性緩衝物件移除。

注入專用軟水劑

使用洗碗碟機專用軟水劑可防止餐具及機件上形成水垢。

- 注意：專用軟水劑儲存器不可空著。
- 注意：必須設定水的硬度。

專用軟水劑儲存器位於洗碗碟機內底部（請參閱「產品介紹」篇章）。必須於控制面板上的「專用軟水劑注入提示」指示燈亮起時將儲存器注滿。

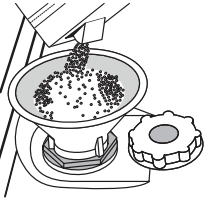

1. 拉出下層層架，扭開儲存器的蓋子(逆時針方向)。
2. 僅供首次使用時：請將軟水劑容器注滿水。
3. 放置漏斗(見左圖) 並倒入專用軟水劑(約1公斤)；若過程中有少量水洩漏，實屬正常。
4. 移除漏斗，並擦去開口處的專用軟水劑殘留物。

確認儲存器的蓋子已擰緊，以確保在清洗過程中沒有清潔劑進入儲存器內(這可能會損壞軟水劑而無法修復)。每當您需要添加專用軟水劑時，我們建議在清洗程序開始前進行添加。

設定水的硬度

為了使軟水劑能完善地運作，我們必須確保水的硬度設置是依照家居水喉水的硬度而定。有關信息可從本地供水商獲得。一般的出廠設置為平均 (3) 水硬度。

- 按下電源「開/關 / 重設」鍵，以啟動洗碗碟機。
- 按下電源「開/關 / 重設」鍵以關閉洗碗碟機。
- 按住「啟動/暫停」鍵5秒，直至聽到「呖」一聲。
- 按下電源「開/關 / 重設」鍵，以啟動洗碗碟機。
- 當前水硬度的所屬級別和「洗碗碟機專用軟水劑注入提示」指示燈均會閃爍。
- 按下「程序」鍵P以選擇所需的水硬度水平(請參閱「軟水/硬水程度表」)。

軟水/硬水程度表				
程度	°dH	°fH	°Clark	
1 軟	0 - 6	0 - 10	0 - 7	
2 中度	7 - 11	11 - 20	8 - 14	
3 平均	12 - 16	21 - 29	15 - 20	
4 硬	17 - 34	30 - 60	21 - 42	
5 最硬	35 - 50	61 - 90	43 - 62	

- 按下電源「開/關 / 重設」鍵，以關閉洗碗碟機。

設置完成！

完成上述步驟後，立即於不加載碗碟的情況下運行一次程序。只能使用專為洗碗碟機設計的專用軟水劑。

倒入專用軟水劑後，「洗碗碟機專用軟水劑注入提示」指示燈將熄滅。

若沒有加入專用軟水劑，軟水劑和加熱配件可能因此而損壞。使用清潔劑是建議加入軟水劑一起使用。

注入吹乾劑

吹乾劑可使碗碟更容易乾透，必須於控制面板上的「洗碗碟機吹乾劑注入提示」指示燈亮起時將吹乾劑注入吹乾劑盒A內。

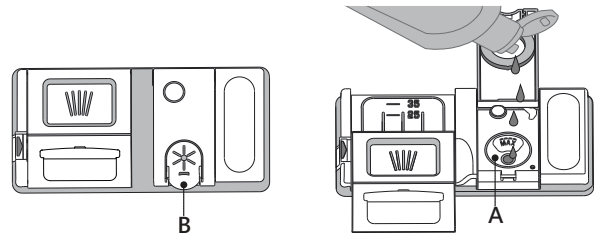

1. 按下及拉起吹乾劑盒蓋子(B)
2. 小心地倒入吹乾劑(最多110ml)直至填滿盒子，避免液體溢出。若吹乾劑滲漏，請立即用乾布抹乾。
3. 按下蓋子，直至聽到「喀噠」一聲，以確認關閉蓋子。

切勿將吹乾劑直接倒入洗碗碟機內桶。

調整吹乾劑的劑量

若乾透程度未如理想，可以調整吹乾劑的使用量以加強效果。

- 按下電源「開/關 / 重設」鍵，以啟動洗碗碟機。
- 按下電源「開/關 / 重設」鍵，以關閉洗碗碟機。
- 按「P」鍵3次，會聽到「呖」一聲。
- 按下電源「開/關 / 重設」鍵，以啟動洗碗碟機。
- 當前所選吹乾劑級別及「洗碗碟機專用吹乾劑注入提示」指示燈均會閃爍。
- 按下「程序」鍵P以選擇所需吹乾劑的劑量級別。
- 按下電源「開/關 / 重設」鍵，以關閉洗碗碟機。

設置完成！

若吹乾劑級別設置為1(ECO)，系統將不會使用吹乾劑。若吹乾劑已用畢，「低用量洗碗碟機專用吹乾劑注入提示」指示燈將不會亮起。

根據洗碗碟機型號，最多可設置5個級別。出廠設置因個別型號而定，請按照相關說明為您的機器進行檢查。

- 如果你看到餐具上有藍色條紋，請設置較小的數字(2-3)。
- 如果餐具上有水滴或水垢，請設置一個較大的數字(4-5)。

注入清潔劑



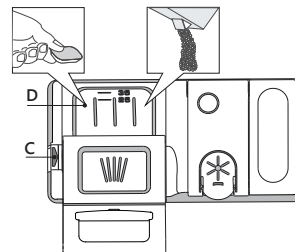









按一下(C)鍵打開清潔劑盒。請確保清潔劑只放入乾爽的裝置D內，然後把用於預洗的清潔劑份量直接倒入內桶。



1. 測量清潔劑時，請參閱早前提及的資訊以添加適當份量。裝置D內有刻度標示以幫助施加適量清潔劑份量。
2. 移除清潔劑盒框邊多餘的清潔劑殘留物。關閉蓋子直至聽到「喀噠」一聲。
3. 拉起清潔劑盒的蓋子，直至關閉裝置到位，清潔劑盒的蓋子關上。

根據程序，清潔劑盒會在合適的時間自動打開。如果使用多合一清潔片，我們建議使用「洗碗碟機專用清潔片」按鈕，因為程序會調整至獲得最佳的洗滌和烘乾的效果。使用非洗碗碟機專用清潔劑可能會導致機器故障或損毀。

程序表

程序	烘乾階段	自然風乾	可用選項*	預設清洗程序時間 (小時:分鐘)**	耗水量 (公升/循環)	能源消耗 (千瓦小時/循環)
1. 省電洗 ECO 50°	✓	✓	  	3:10	9.5	0.85
2. 第6感智能感應清洗®  50-60°	✓	✓	MULTI ZONE   	1:25 - 3:00	7.0 - 14.0	0.90 - 1.40
3. 密集洗 	✓	✓	MULTI ZONE   	2:50	16.0	1.60
4. 快洗快乾 	✓	✓	MULTI ZONE  	1:25	11.5	1.10
5. 玻璃清洗 	✓	✓	MULTI ZONE  	1:40	11.5	1.20
6. 30分鐘快洗 	-	-	MULTI ZONE  	0:30	9.0	0.50
7. 寧靜洗 	✓	✓	 	3:30	15.0	1.15
8. 預洗(冷水) 	-	-	MULTI ZONE 	0:12	4.5	0.01

省電洗程序的數據是根據歐洲標準EN60436：2020在實驗室條件下測量的。
在任何清洗程序開始之前，都不需要對餐具進行人手預洗。

*) 並非所有選項都可以同時使用。

**) 顯示器或本說明書中顯示的清洗程序時間是根據標準條件計算的估計值。實際時間可能因許多因素而異，例如進水的溫度和壓力、室溫、清潔劑的數量、負載量和類型、負載平衡、其他選擇的選項和傳感器的校準。傳感器校準可將清洗程序時間延長至20分鐘。

程序

清洗程序的詳細說明。

1 省電洗

適用於一般骯髒的餐具，此為標準清洗程序，在能源消耗和耗水量方面，綜合消耗的結果來看，效率為最高。

2 第6感智能感應清洗®

適用於一般骯髒，並其表面附有已乾透的食物殘渣的餐具。系統會根據餐具上的污染程度相應地調整程序，調整時顯示屏會出現動畫，系統會自動更新清洗程序的時間。

3 密集洗

建議用於嚴重骯髒的餐具，特別適用於平底鍋和燉鍋(不適用於精緻易碎的物品)。

4 快洗快乾

適用於一般骯髒的碗碟，適用於日常操作的清洗程序，可確保在更短的時間內實現最佳的清潔和乾燥性能。

5 玻璃清洗

適用於對高溫有較高敏感度的精緻物品(例如玻璃和杯子)。

6 30分鐘快洗

程序用於清洗半負載的輕度骯髒，並其表面沒有乾透的食物殘渣的餐具。此程序不包含烘乾階段。

7 寧靜洗

適合用於夜間操作。能確保於低噪音運作下展現最高的清洗及烘乾效能。

8 預洗(冷水)

適用於待洗的餐具。此程序不需使用任何清潔劑。

備註:當使用「30分鐘快洗」程序時，需留意最多可放置的餐具數目，以達至最理想的清潔效能。

選項及功能

透過按下相應按鈕，可直接揀選所需選項(請參閱「控制面板」篇章)。

如果某個選項與所選程序不兼容(請參閱「程序表」)，相應的LED指示燈將快速閃爍3次，並發出「唸」一聲。屆時該選項將不會成功被啟用。

MULTI ZONE 「多區選擇」

如所需清洗的餐具數量不多，可以使用半量清洗設定，以節省水、電和清潔劑。選擇程序並按下「多區選擇」按鈕：按鈕上方的指示燈將會亮起，目標層架的符號將呈現於顯示屏上。在一般情況下，程式會預設成清洗所有層架。如欲清洗特定層架，需重覆按此按鈕：

 顯示屏上顯示 (只清洗下層層架)

 顯示屏上顯示 (只清洗上層層架)

 顯示屏上顯示 (只清洗餐具層架)

 顯示屏上顯示(選項為OFF，設備將清洗所有層架中的餐具)。

請謹記：僅裝載上層層架或下層層架時，請相應地減少清潔劑的量。

若上層層架已經移除，請直接將洗碗碟機專用清潔劑加入桶內，而非加入清潔劑盒。

「兒童安全鎖」

長按(3秒)「多區選擇」按鈕，將啟動「兒童安全鎖」功能。「兒童安全鎖」啟動後，除電源「開/關/重設」鍵外，控制面板將被鎖上。若要取消啟動「兒童安全鎖」，請再次長按(3秒)「多區選擇」按鈕。

「水龍頭關閉」- 提示

沒有進水或水龍頭關閉時，相關指示燈將會閃爍。

POWER CLEAN®

配備額外的強力噴灑臂，為下層層架提供更密集，更強勁的清洗效果。此選項建議用於清洗煲和鍋。按此按鈕啟動POWER CLEAN® (指示燈將會亮起)。

「洗碗碟機專用清潔片」

此設置允許您根據所用清潔劑的類型來優化程序的表現。按下「POWER CLEAN®」按鈕3秒，可啟動選項。如果您使用片劑形式的多合一洗碗碟機專用清潔片(軟水劑、吹乾劑和清潔劑)，相應的符號將亮起。

如果使用洗碗碟機專用清潔粉末或清潔液，則應關閉此選項。

「預校開機時間」

可選擇延遲30分鐘至24小時才啟動清洗程序。

1. 選擇程序和所需選項。重複按下「預校開機時間」按鈕以延遲程序的啟動。可在30分鐘至24小時之間作調節。

每按一下此按鈕：

若選擇低於4小時，延遲時間將增加30分鐘；

若選擇低於12小時，延遲時間將增加1小時；

若選擇超過12小時，延遲時間將增加4小時；

若達到24小時，再按下按鈕，將會停用延遲選項。

2. 按下「啟動/暫停」鍵：計時器開始倒數；

3. 時間結束後，指示燈熄滅，清洗程序便會自動開始。

若於倒數過程中再次按下「啟動/暫停」鍵，「預校開機時間」選項將被取消，所選程序將自動啟動。

一旦清洗程序啟動，將無法再設置「預校開機時間」選項。

「排水」

清洗程序運行中的時候，若需要中途停止/取消清洗程序，可以使用「排水」功能。

長按「啟動/暫停」鍵，啟動「排水」功能，清洗程序將被終止，洗碗碟機內的水亦會被排走。

自然風乾

自然風乾是一個對流風乾系統，透過於烘乾程序進行過程中/完成後，洗碗碟機自動打開機門從而達至非凡的風乾效果。機門會於洗碗碟機達至安全合適的溫度時自動打開。

洗碗碟機會加入特別設計的阻擋器作為額外蒸氣保護(視乎洗碗碟機型號而定，或需加購)。有關增加阻擋器，請參閱「安裝指引」。

用家可透過以下步驟設定自然風乾：

- 關閉設定：按開關鍵啟動洗碗碟機，再關閉洗碗碟機，長按「P」鍵5秒，5秒後洗碗碟機會長響「唸」聲。再次啟動洗碗碟機，螢幕會顯示「oOff」
- 啟動設定：按開關鍵啟動洗碗碟機，再關閉洗碗碟機，長按「P」鍵5秒，5秒後洗碗碟機會長響「唸」聲。再次啟動洗碗碟機，螢幕會顯示「oOn」

裝置層架

餐具層架

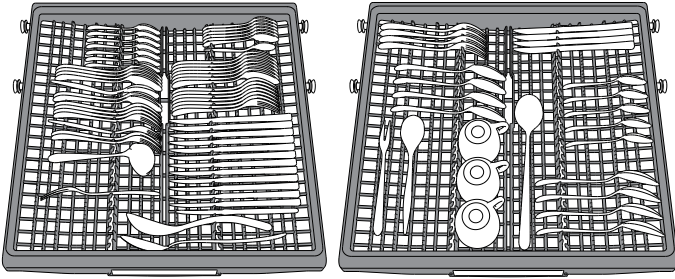

第三層架的設計是用於放置餐具。如圖所示排列餐具。餐具層架設計使餐具能獨立擺放，使清洗後收集變得更容易，同時亦改善清洗和烘乾性能。

餐刀和其他具有鋒利邊緣的餐具必須定位擺放，刀片朝下。層架的幾何形狀使小物品(如咖啡杯)能安放在層架中央。

上層層架

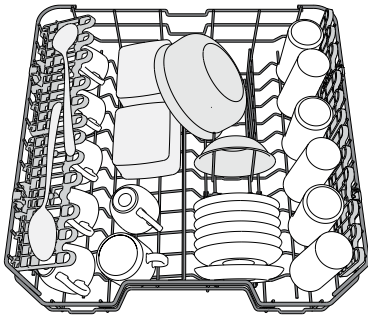

(上層層架的加載示範)

擺放精緻和輕巧的器具：玻璃、杯子、碟子、沙律碗。上層層架設有翻倒支撐設計，支撐部分垂直時可支撐擺放茶杯/醬料碟；支撐部分放下時可擺放碗及其他食物盒。

調整上層層架高度

上層餐具層架的高度可以調節：調高後，以便在下層層架和低位置放置較大型的器具；調低後，可為上層騰出更多空間，避免上下層器具互相碰撞而打翻。

上層層架備配有高度調節器(見圖)，不需按下手柄，只需握住層架兩側即可將其抬起並固定位置。要恢復到較低位置，請按下上層層架兩側的桿A並向下移動籃子。

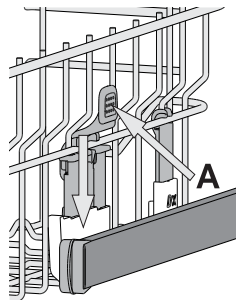

我們強烈建議於層架載滿時不要調節層架高度。切勿僅升高/降低單側層架。

可調節位置的可摺疊盛載器

側面可摺疊的盛載器可以設定在三個不同的高度，以優化機架內的餐具放置。

將酒杯腳卡在可摺疊的盛載器上，令酒杯可以安放於洗碗碟機內。

視乎洗碗碟機型號而定：

- 若想收起盛載器，需要將盛載器向上滑動並旋轉以從按扣上釋放，然後將其拉下。
- 若想展開盛載器，需要將盛載器向下滑動並旋轉以從按扣上釋放，然後將其拉下。

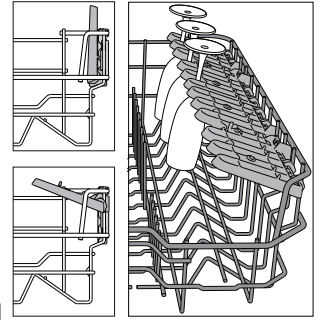

下層層架

用於煲、蓋、碟子、沙拉碗、餐具等。大型碟子和蓋子應放在兩側，以避免阻擋噴灑臂。

下層層架具有翻倒支撐設計，既可垂直擺放碟子，亦可將平底鍋和沙律碗平放於下層層架上。

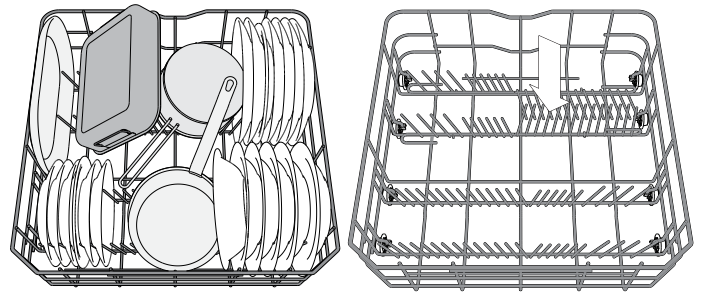

(下層層架的加載示範)

POWER CLEAN®

Power Clean® 配備特別的噴灑系統，於後方以高強度的水柱清洗高骯髒程度的碗碟。下層層架設有一個特別的空間，可從層架後方拉出翻倒支撐設計，用來支撐平底鍋或烤盤，令其可以豎直放置，從而節省佔用空間。將平底鍋或烤盤面向Power Clean® 組件後，請於操控面板上揀選 **POWER CLEAN®** 選項。

如何使用Power Clean®:

1. 調整Power Clean® 空間 G
向下折疊翻倒支撐設計，以放置平底鍋。
2. 在 Power Clean® 區域內垂直擺放平底鍋或烤盤。平底鍋或烤盤必須傾斜向噴灑系統。

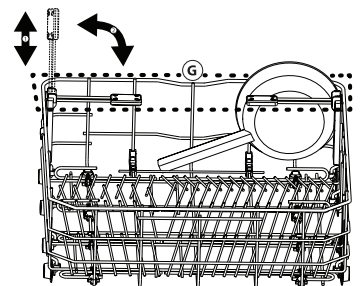
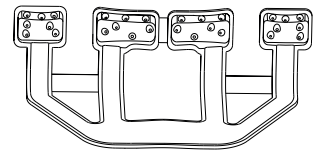

日常使用

1. 檢查水喉連接

檢查洗碗碟機是否連接到供水系統並且頂部是否打開。

2. 開啟洗碗碟機

按下電源「開/關 / 重設」鍵。

3. 負載層架

(請參看「裝置層架」篇章)。

4. 注入清潔劑盒

5. 選擇程序並自訂選項

按下「程序」(P) 按鈕，根據餐具類型及其污染程度選擇最合適的程序(參見程序說明)。

選擇所需的選項(請參閱「選項和功能」篇章)。

6. 開始

按「啟動/暫停」鍵開始清洗程序。程序啟動時，您會聽到「咁」聲。

7. 結束清洗程序

清洗程序結束時會發出連續的「咁」聲，顯示屏會顯示「END」。打開門，按電源「開/關 / 重設」鍵，以關閉設備。數分鐘後才取出餐具，以免燙傷。從下層層架開始卸載。

若洗碗碟機靜止一段時間，設備將會自動關閉，以減少電力消耗。如果餐具只是輕微弄髒，或者在放入洗碗碟機之前已經用水沖洗過，那麼可適當地減少清潔劑的使用量。

修改運行中的程序

如果選擇了錯誤的程序，可於程序剛啟動時作出修改：按住電源「開/關 / 重設」鍵關閉機器。使用電源「開/關 / 重設」鍵重新啟動機器，再次選擇新的清洗程序和所需的選項。按「啟動/暫停」鍵開始程序。

添加額外餐具

不需關閉機器，打開門(注意：小心熱蒸氣!)將餐具放入洗碗碟機內，關門並按「啟動/暫停」鍵，程序將從中斷點開始重啟。

運行中的程序中斷

如果在清洗程序期間打開門或者斷電，清洗程序會暫停。當機門關閉或電源恢復後，按「啟動/暫停」鍵，程序將再次從中斷點開始重啟。

若要關閉示範模式，必須連續執行以下動作。

打開機器，然後再次將其關閉。按下「預校開機時間」按鈕，直到聽到蜂鳴聲。再次啟動機器。「dOF」指示燈閃爍，然後熄滅。

建議及提示

小貼士

在裝入餐具層架前，先清空玻璃餐具內所有物件並從餐具中去除所有的食物殘渣。**不需要預先沖洗餐具。**

適當放置餐具使其牢牢固定於層架上，不會翻倒。將容器開口朝向下放置，凹/凸部分傾斜放置，從而令水能觸及每個表面並自由流動。

警告：確保蓋子、手柄、托盤及煎鍋不會阻止噴灑臂旋轉。

將所有小物品放在餐具籃中。

非常骯髒的餐具和平底鍋應放置於下層層架裡，因為在這個區域噴水更強，洗滌效能更高。

完成放置餐具及層架後，必須確保噴灑臂可以自由旋轉。

不合適的餐具

- 木製餐具。
- 配有精緻但耐用性較低的裝飾的玻璃，藝術工藝品和古董。
- 合成材料中不能承受高溫的物件。
- 銅和錫餐具。
- 被灰、蠟、潤滑劑或油墨弄髒的餐具。

在清洗過程中，玻璃裝飾和鋁/銀碎片的顏色會發生變化和褪色。某些類型的玻璃(例如水晶)也可能在多次清洗程序後變得不透明。

對玻璃餐具和其他餐具的損害

- 只能使用製造商保證的適用於洗碗碟機的玻璃和餐具。
- 使用適合精緻餐具的清潔劑。
- 清洗程序結束後，立即從洗碗碟機中取出玻璃餐具和其他餐具。

節約能源小貼士

- 根據製造商的說明使用家用洗碗碟機時，在洗碗碟機中洗滌餐具通常比手洗餐具消耗更少的能源和水。
- 為了最大程度地提高洗碗碟機的效率，建議在洗碗碟機滿載後才運行清洗程序。根據製造商指示的容量放置餐具及碗碟，將有助節省能源和水。有關正確放置餐具的信息，請參閱「裝置層架」篇章。
- 如只放置一半碗碟，可行情況下建議使用特定的功能選項(半負載/區域清洗、多區選擇)，並只放置於特定的層架。洗碗碟機的不正確負載或超載，可能會增加資源的使用量(例如水、能源和時間，並增加噪音水平)，從而降低潔淨和乾燥性能。
- 不建議手動預洗餐具，因為這樣會導致用水和能源消耗增加。

衛生

為避免氣味和沈澱物積聚於洗碗碟機內，請至少每月運行一次高溫程序。使用茶匙份量的清潔劑，並在沒有裝載的情況下運行高溫程序來清潔您的設備。

保養及維修

清潔過濾器組件

定期清潔過濾器組件，使過濾器不會堵塞，並使污水正確排出。

如果洗碗碟機的過濾器堵塞，或者過濾系統或噴灑臂內有異物，可能會導致設備故障，導致洗碗碟機清潔性能下降、運作時產生噪音或耗用大量能源。

過濾器組件由三層過濾器組成，這些過濾器可於水循環的過程中從水中去除食物殘渣。

請勿在沒有過濾網或過濾網鬆脫的情況下使用洗碗碟機。

每個月一次或經過30個循環後，需要檢查過濾器組件，並在必要時使用非金屬刷子並按照以下說明在流水下徹底清洗過濾器：

1. 沿逆時針方向轉動圓柱形過濾器A並將其拉出(圖1)。
2. 通過在側翼上施加輕微壓力來移除杯式過濾器B(圖2)。
3. 滑動不鏽鋼板式過濾器C(圖3)。
4. 若發現任何外來物(例如碎玻璃、瓷、骨頭、水果種子等)請小心移除。
5. 檢查疏水閥並清除任何殘留物。切勿拆除洗滌循環泵保護器(黑色細節)(圖4)。

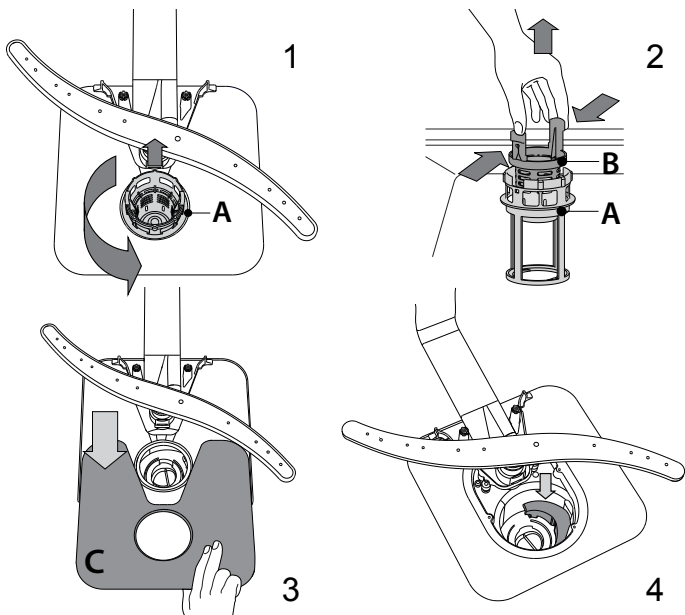

為確保洗碗碟機的運行暢順及有效，清潔過濾器後，必須重新將過濾器組件固定到正確位置。

清潔進水口軟管

如果水管是新的或長時間未使用，請在進行必要的連接之前讓水運行以確保其清澈且無雜質。如果不採取這種預防措施，進水口可能會堵塞並損壞洗碗碟機。

清潔噴灑臂

食物殘渣有時可能會殘留在噴灑臂的外殼上，並堵塞噴水孔。因此，我們建議您時常檢查噴灑臂，並用細小的非金屬刷子清潔它們。

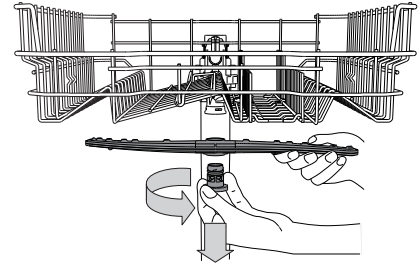

如要卸上下層噴灑臂，請按逆時針方向轉動。裝上層噴灑臂時，孔數較多的一側朝上。

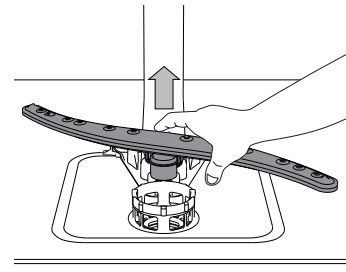

可以通過向上拉動下層噴灑臂來移除下層噴灑臂。

軟水系統

軟水器會自動降低水的硬度，從而防止水垢積聚在加熱器上，也有助於提高清潔效率。

軟水系統需要通過軟水劑才能運作，因此在軟水器空置時，需要重新注滿軟水劑盒。

軟水頻率取決於水硬度等級設置-每6個Eco循環進行一次再生，水硬度等級設置為3。

再生過程始於最尾段的沖洗階段，並在循環結束之前在乾燥階段結束。

- 單次運行消耗: ~3.5公升水;
- 每個週期最多需要額外5分鐘;
- 能量消耗低於0.005 kWh。

故障排除

此洗碗碟機可能因為某些原因而不能正常運作。
聯絡售後服務中心之前，建議先自行進行檢查，看問題是否可以使用以下列表的簡易方法解決。

問題	可能原因	解決方法
☒ 「專用軟水劑注入提示」指示燈亮起	軟水劑儲存器是空的。(重新注滿軟水劑後，指示燈可能仍然會維持點亮數個洗滌週期)。	注入軟水劑。有關調整水的硬度(更多資訊請參閱「首次使用 - 洗碗碟機專用軟水劑、吹乾劑、清潔劑」篇章)。
☼ 「吹乾劑注入提示」指示燈亮起	吹乾劑盒是空的。(重新注滿吹乾劑後，指示燈可能仍然會維持點亮數個洗滌週期)。	於吹乾劑盒注入吹乾劑。(更多資訊請參閱「首次使用 - 洗碗碟機專用軟水劑、吹乾劑、清潔劑」篇章)。
洗碗碟機無法啟動或不能依據指令運作。	設備的電源插頭未正確連接。	將電源插頭插入插座。
	電源故障。	出於安全原因，當電源恢復時，洗碗碟機將不會自動重新啟動。打開洗碗碟機機門，按「啟動/暫停」按鈕，然後在4秒鐘內關閉機門。
	洗碗碟機的機門沒有完全關閉。自然風乾系統的門針沒有到位。	大力推門直至聽到「喀噠」聲。
	開門超過4秒。	按下「啟動/暫停」並在4秒鐘內關閉機門。
洗碗碟機對操作指令無反應。 顯示屏顯示：F9或F12，開/關鍵的LED燈快速閃爍	洗碗碟機對操作指令無反應。 顯示屏顯示：F9或F12，開/關鍵的LED燈快速閃爍	按下「開/關」按鈕關閉設備，大約一分鐘後將其重新打開，然後重新啟動程序。如果問題仍然存在，請拔下設備的電源插頭1分鐘，然後再將其重新插入。
	清洗程序尚未完成。	等待清洗程序結束。
	排水喉扭曲。	檢查排水喉確保沒有扭曲(請參閱「安裝指引」篇章)。
	水槽的排水喉阻塞。	清潔水槽的排水喉。
洗碗碟機無法排水。	過濾網被食物殘渣堵塞。	清潔過濾網(請參閱「清潔過濾網組件」篇章)。
	顯示屏：F3「開/關」按鈕的LED燈快速閃爍	
洗碗碟機操作時噪音過大。	碗碟及餐具間發出「叮叮噹噹」的聲音。	正確擺放餐具(請參閱「裝置層架」篇章)。
	過多的泡沫形成。	使用錯誤份量的清潔劑，或清潔劑不適合用於該洗碗碟機(請參閱「注入清潔劑」篇章)。按下排水鍵重新啟動洗碗機，選擇新程序，請不要添加任何清潔劑。
餐具沒有完全潔淨。	餐具沒有安放適當位置。	正確安置餐具(請參閱「裝置層架」篇章)。
	噴灑臂受到餐具的阻礙，不能自由旋轉。	正確安置餐具(請參閱「裝置層架」篇章)。
	清洗程序太溫和。	選擇合適的清洗程序(請參閱「程序表」篇章)。
	過多的泡沫形成。	使用錯誤份量的清潔劑，或清潔劑不適合用於該洗碗碟機(請參閱「注入清潔劑」篇章)。
	清潔劑儲存器的蓋子未正確關閉。	確保清潔劑儲存器的蓋子已關閉。
	過濾網骯髒或堵塞。	清潔過濾網組件(請參閱「保養及維修」篇章)。
洗碗機未注滿水。	無加入洗碗碟機專用軟水劑。	加入洗碗碟機專用軟水劑(請參閱「注入專用軟水劑」篇章)。
	供水無水或水龍頭關閉。	確保供水或水龍頭是運行中有水。
	顯示屏顯示：☼及F6「開/關」按鈕的LED燈快速閃爍	確保進水軟管沒有彎曲(請參閱「安裝指引」篇章)，並重新啟動洗碗碟機。
洗碗碟機提前完成洗滌循環。 顯示屏顯示：F15「開/關」按鈕的LED燈快速閃爍	進水軟管彎曲了。	進行驗證和清潔後，關閉並打開洗碗機，然後重新啟動新程序。
	排水軟管位置過低或家庭污水處理系統出現虹吸作用。	檢查排水軟管的末端是否放置在正確的高度(請參閱「安裝指引」篇章)。檢查家庭污水處理系統是否出現虹吸作用，必要時安裝進氣閥。
	供水有氣泡。	檢查供水是否有洩漏或其他問題，以免空氣進入。

維修和故障排除指引

如要獲得更多資訊，請參閱「使用說明及安裝指南」。
「使用說明及安裝指南」可以透過以下方式獲取：

- 請致電保用證上顯示的號碼，聯絡售後服務中心。
- 於網站內可下載：www.whirlpool.com.hk

致電售後服務中心

當您致電售後服務中心前，您必須提供安裝在洗碗碟機門內左側或右側的銘牌上顯示的代碼，詳情請參照以下網址：www.whirlpool.com.hk

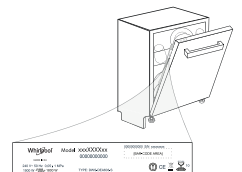

400011559496
07/2021 as - Xerox Fabriano

