

Whirlpool

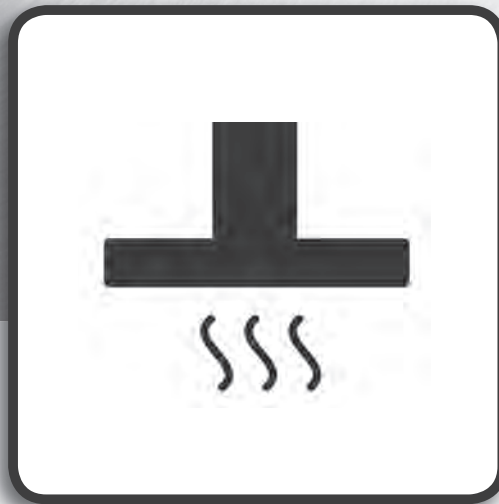

Health & Safety Use & Care and Installation guide

Model : AKR5101/IX



www.whirlpool.com.hk

This manual and the appliance itself provide important safety warnings, to be read and observed at all times.

CONTENTS

- IMPORTANT SAFETY INFORMATION
- INSTALLATION
 - PREPARING FOR INSTALLATION
 - ELECTRICAL CONNECTION
 - GENERAL RECOMMENDATIONS
- OPERATION
 - NORMAL OPERATION
 - DELAYED OFF
- MAINTENANCE
 - GREASE FILTER
 - LIGHT BULB
 - HOOD CLEANING
- INSTALLATION DIMENSIONS
- MATERIAL SUPPLIED
- TROUBLE SHOOTING GUIDE
- PRODUCT SPECIFICATION & TECHNICAL PARAMETERS

IMPORTANT SAFETY INFORMATION

1. Installation must be carried out by a specialized technician, in compliance with the manufacturer's instructions and local safety regulations. Do not repair or replace any part of the hood unless specifically indicated in the manual. All other maintenance services must be carried out by a specialized technician.
2. Always disconnect the hood from the power supply before carrying out any installation or maintenance operation on the appliance.
3. Earthing of the appliance is compulsory.
4. Never use multisockets and extension leads.
5. The electrical components must no longer be accessible to the user after installation.
6. Do not touch the hood with wet parts of the body or use it when barefoot.
7. Do not pull the appliance power cable to unplug the appliance.
8. When drilling the wall, make sure not to damage the electrical connections and/or pipes.
9. The ventilation ducts must always discharge to the outside.
10. The Manufacturer declines any liability for improper use or incorrect setting of the controls.
11. This appliance is not intended for use by persons (including children) with reduced physical, sensory or mental capabilities, or lack of experience and knowledge, unless they have been given supervision or instruction concerning use of the appliance by a person responsible for their safety.
12. Keep children away.
13. To reduce the risk of fire, only use a metal inlet duct.

14. Children must be supervised so that they do not play with the appliance.
15. The product must be disposed of in compliance with local regulations on waste disposal.
16. For further information on the treatment, recovery and recycling of this product, contact the competent local office, the household waste collection service or the shop where you purchased the appliance.
17. Regular cleaning and maintenance is essential for correct hood operation and good performance. Frequently clean all encrustations from dirty surfaces to prevent the accumulations of grease. Regularly clean or replace filters.
18. Do not put fire source under the hood, naked flames could cause a fire.
19. The room must have adequate ventilation when the hood is used at the same times as appliances operating on gas or other fuels.
20. The discharge air must not be eliminated in a duct used to remove fumes produced by appliances operating on gas or other fuels, but must have a separate outlet. All the national regulations on air discharge envisaged by art. 7.12.1 of CEI EN 60335-2-31 must be observed.
21. If the hood is used together with other appliances operating on gas or other fuels, the negative pressure in the room must not exceed 4 Pa (4×10^{-5} bar). Therefore, make sure the room is adequately ventilated.
22. Do not leave pans unattended when frying, since the cooking oil could catch fire.
23. Make sure the lamps are cold before touching them.
24. The hood is not a shelf, therefore do not overload or place objects on it.
25. Do not use or leave the hood without its lamps correctly installed – risk of electric shock.
26. Wear work gloves for all installation and maintenance operations.

27. The product is not suitable for outdoor use and is designed for domestic use only.
28. The air sucked by the hood must not be eliminated through the same flue of the heating system or other appliances using gas or other fuels.
29. There is a risk of fire if cleaning is not carried out in accordance with the instructions.
30. CAUTION: Accessible parts may become hot when used with cooking appliances.

INSTALLATION

After unpacking the appliances, check for any transport damage. In the event of problems, contact the After-Sales Service. To prevent any damage, only remove the appliance from its polystyrene foam packaging at the time of installation.

Preparing For Installation

1. This is a heavy product; the hood should only be lifted and installed by two or more people.
2. The minimum distance between the top of cooker and the bottom of the hood must not be less than 650mm for a gas hob, and 550mm for an electric hob. If the installation instructions for the cooker specify a greater distance between cooker and hood, this distance must be observed.

Electrical Connection

1. Make sure the power voltage specified on the appliance rating plate is the same as the mains voltage. This information can be found inside the hood.
2. Before reconnecting the hood circuit to the power supply and checking correct operation, always make sure the power cable is correctly fitted and that it was NOT crushed in its housing during installation. Make sure to have this operation carried out by a qualified technician in accordance with all local codes and standards.

3. Turn off electrical power before installation.
4. If the supply cord is damaged, it must be replaced by the manufacturer, its service agent or similarly qualified persons in order to avoid a hazard.
5. Do not use plug and extension cord other than the one provided.
6. Earthing of this hood is compulsory, do not remove ground connection of the plug.

General Recommendations

➤ Before use

Remove cardboard protection pieces, protective film and adhesive labels from accessories. Check the appliance for any transport damages.

➤ During use

To avoid any damage do not place any weights on the appliances. Do not expose the appliance to atmospheric agents.

➤ Mount the Hood Body

1. Drill the holes according to the distances indicated in Fig.2.
2. Fix the support bracket to the wall and hook the hood on the support bracket for hooking it to the wall. Adjust the distance between the hood and wall and align it in horizontal position to the wall units. Adjust the hood horizontally using a level.
3. When the appliance has been adjusted, fully tighten the support using the screws A. The hood comes with all the materials required for installation on the majority of walls/ceilings (reinforced concrete, plasterboard...etc.). All installation must be done by qualified technician.

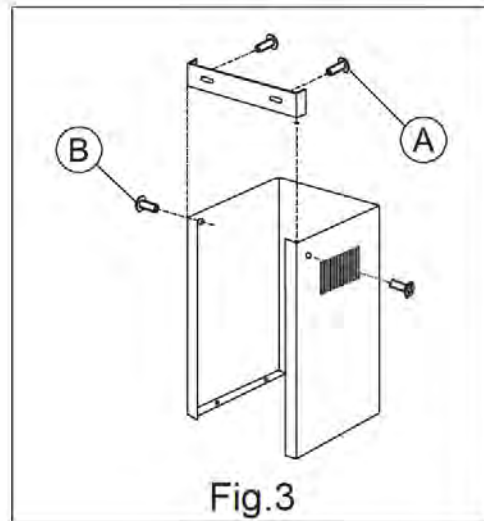
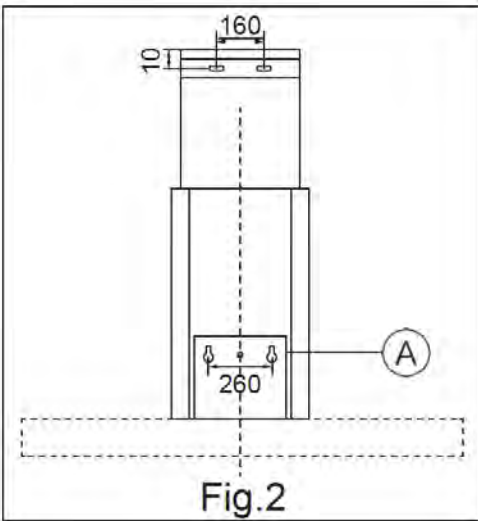

➤ Fitting the chimney

1. Arrange the electrical power supply inside the chimney.
2. Adjust the width of the support bracket of the exterior chimney (Fig.3). Then fix it to the ceiling using the screws A (Fig.2) make sure that it is in line with your hood and respecting the distance from the ceiling indicated in Fig.2. Connect the flange C to the air exhaust hole using a connection pipe (Fig.4).

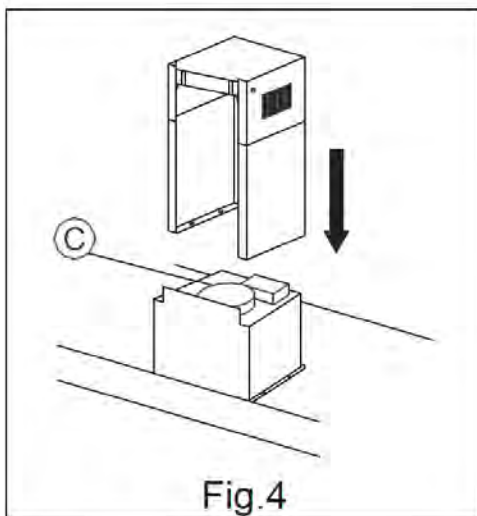

➤ Duct Connection

1. When installing the ducted version, connect the hood to chimney using either a flexible or rigid pipe Ø170 to the recess area of the air outlet adapter.
2. Fix the pipe in position using 2 screws from two sides of the air outlet adapter. Make sure the pipe is secured.

Remarks

1. A straight, short pipe will allow the hood to perform efficiently.
2. Long duct, elbows and transitions will reduce performance of the hood. Use as few as possible. Bigger pipe may need when using long duct.
3. It is suggested to keep a minimum 100cm straight line pipe between bends and elbows for better performance.

OPERATION

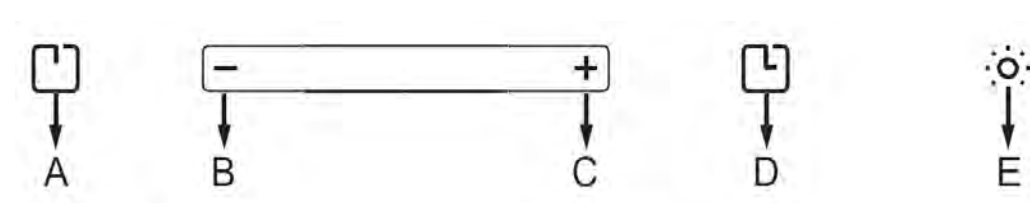

Normal Operation

1. “A” = turn ON/OFF the cooker hood
2. “B” = decrease the speed
3. “C” = increase the speed
4. “E” = turn ON/OFF the lamp

Delayed off

1. “D” = Press once to turn on 15mins delayed off
2. “D” = Press twice to turn off delayed off

MAINTENANCE

Make sure appliance is switch off or unplug before carrying out any maintenance work.

Grease Filter

1. The filters are washable at least every 2 months of operation, or more frequently for particularly heavy usage.
2. Remove the filter one at a time by supporting them with one hand and push the lock to release the filter. (Fig.5)
3. Wash the filters in mild detergent and rinse with warm water. Allow them to dry before refitting.
4. Refit them by pressing the latch on filter.
5. Please pay attention and not to bend aluminum filter during your cleaning process.
6. The filters is dish-washer safe.
7. Please note that filters may alter color after several washes.

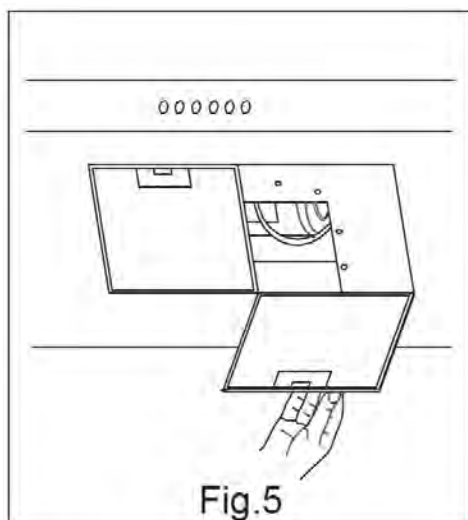

Light Blub

LED lamps are spare parts which cannot be repaired, LED lamps must be replaced. Please contact service agent for replacements.

Hood Cleaning

1. Use soap or mild detergent with hot water to clean the hood.
2. Rinse with water and wipe dry with a dry and clean cloth.
3. For discolorations or deposits that persist, use a non-scratching household cleanser or stainless steel polishing powder with a little water and a soft cloth.
4. For a very dirty hood, please use a plastic scouring pad or soft bristle brush together with cleanser and water. Rub lightly in direction of polishing lines or “grind” of the aluminum finish. Avoid using too much pressure that may mar the surface. Do not use abrasive sponges or metallic scrapers or scourers. Over time, these can damage hood surface and cause rust.
5. Do not use corrosive strong acidic detergent to clean the hood.

INSTALLATION DIMENSIONS

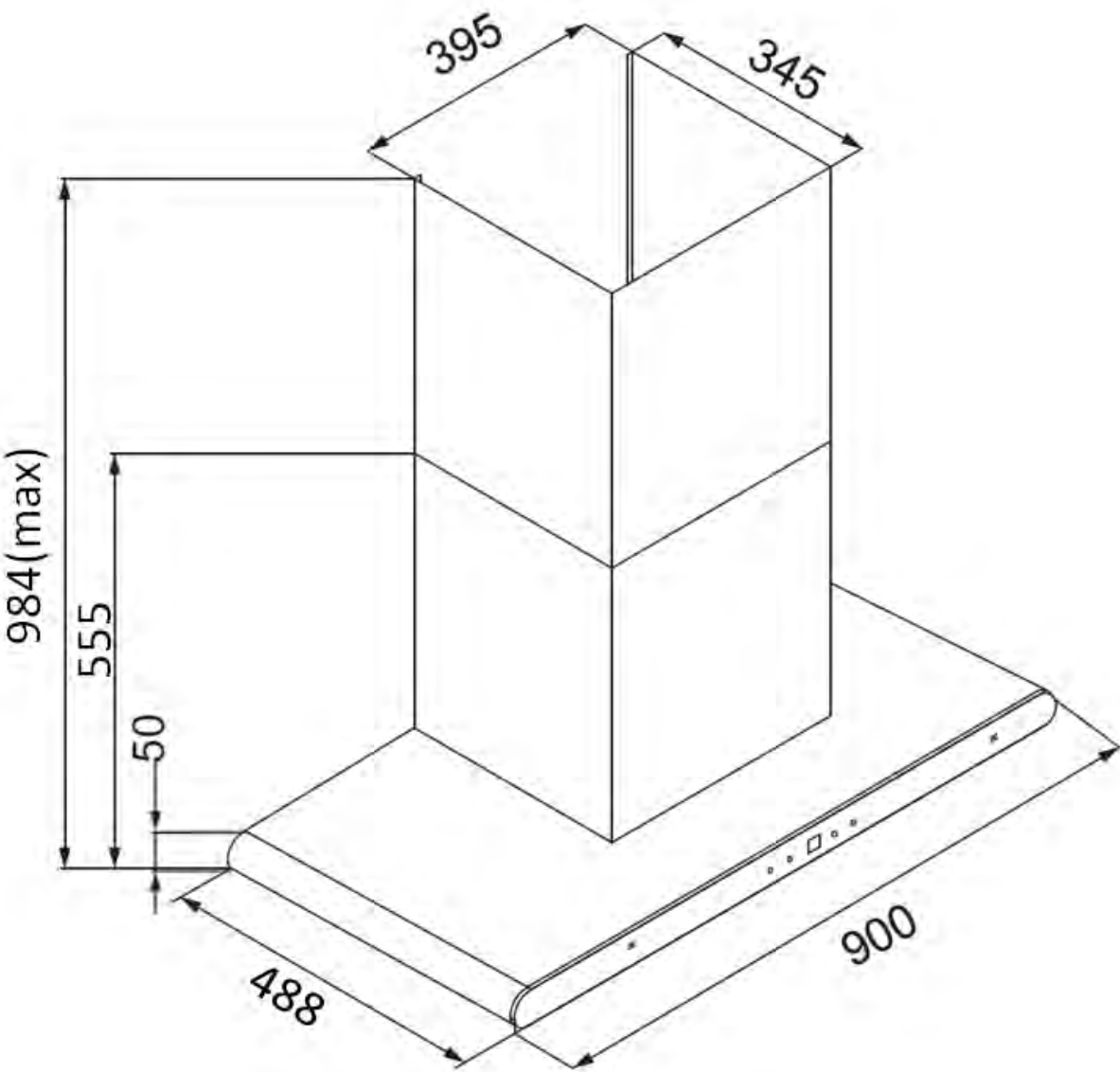

MATERIAL SUPPLIED

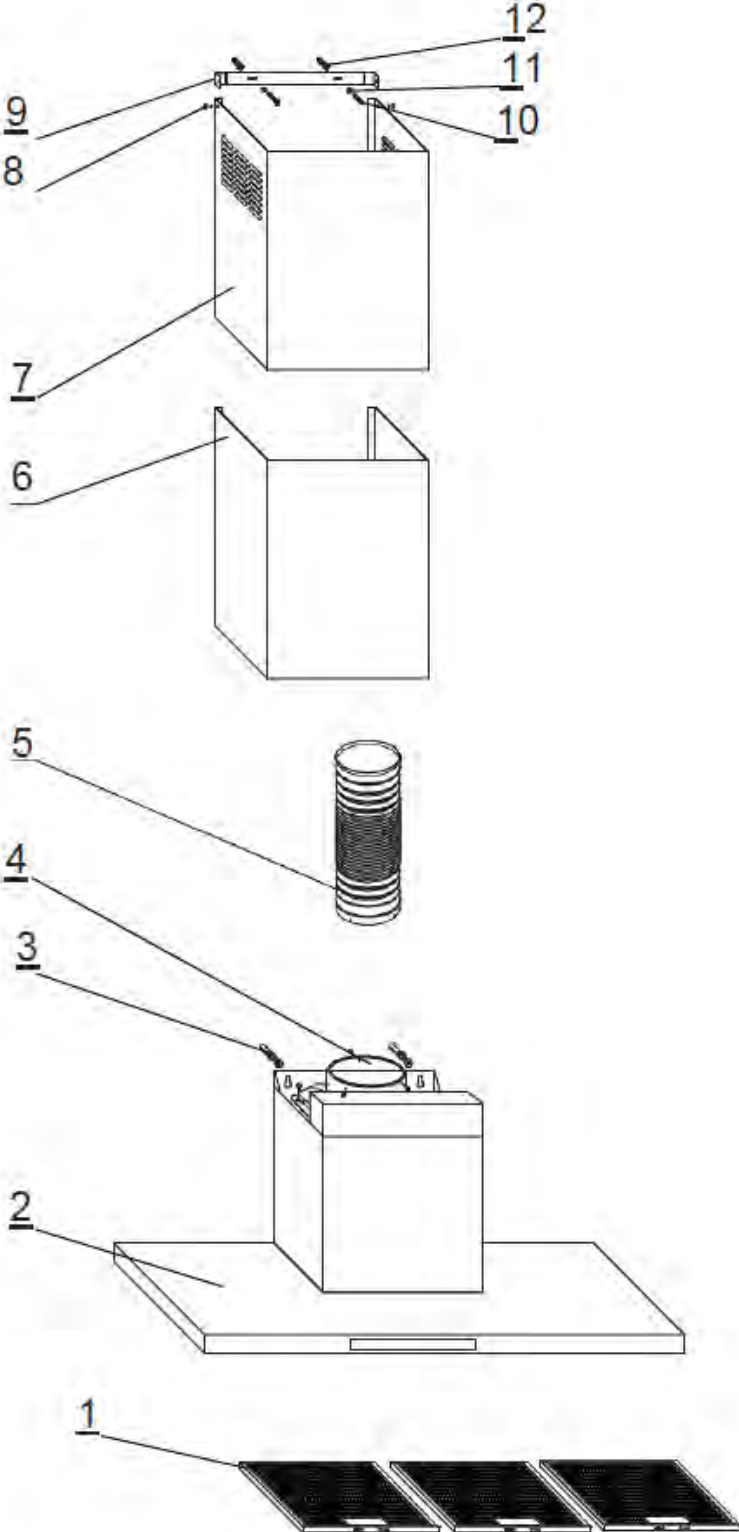

Number	Qty	Components
1	3 pcs	Grease filter
2	1 pcs	Hood body
3	2 pcs	Steel bolt
4	3 pcs	Cross self-drill bolt
5	1 pcs	Exhaust
6	1 pcs	Exterior chimney
7	1 pcs	Inner chimney
8	2 pcs	Cross discal thread bolt
9	1 pcs	Fixing frame
10	2 pcs	Cross discal bolt-big head
11	2 pcs	Flat rubber band
12	2 pcs	Plastic distensible sleeve
13	1 pcs	Instruction manual
14	1 pcs	Warranty card

TROUBLE SHOOTING GUIDE

In case if the cooker hood does not work or work improperly, before calling the after sales service, switch off the appliances, unplug the power supply and refer to the guide below to solve the problem.

S. No.	Status	Reasons	Solutions
1	Lamp doesn't work	Power supply not connected	Check if the power cord is properly connected or not
		Lamp is damaged	Call consumer service for support
2	Hood is noisy	Filter not properly fitted	Remove and refit the filters properly
		Hood is not installed properly	Call consumer service for support
3	Poor performance with low suction	Distance between hood and hob is too high	Call consumer service for support
		Filter is choked	Clean filter and refit in its place
		Duct is damaged	Call consumer service for support

PRODUCT SPECIFICATION & TECHNICAL PARAMETERS

Model	AKR5101/IX
Rated Voltage	220-240V~
Rated Frequency	50Hz
Light Power	2 x 1W
Motor Power	250W
Total Power	252W
Maximum suction	1200m ³ /hr
Diameter of Exhaust Pipe	170mm
Product Dimension (mm)	555-984 H x 900W x 488D
Net Weight / Gross Weight	18.5kg / 23kg

