

用户手册

MM260X / MM250
MM200 / MM220X

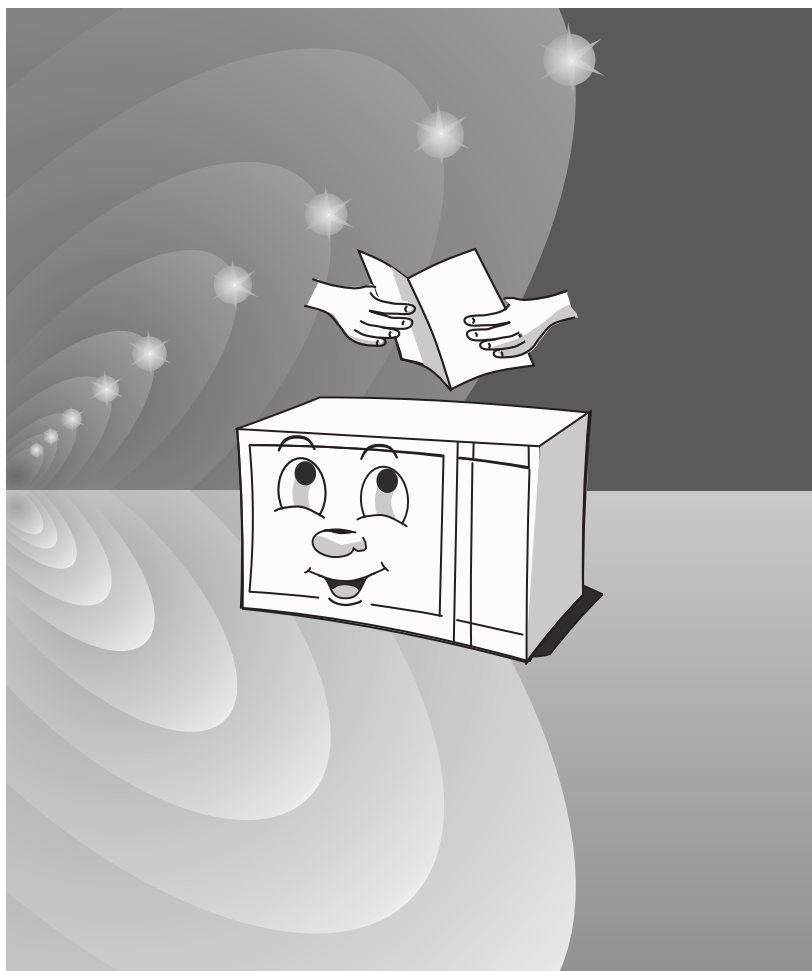

 **Whirlpool**[®]
HOME APPLIANCES

微波爐

用戶手冊

型號：MM260X/MM250
MM200/MM220X

使用微波爐之前請仔細閱讀用戶手冊，并請妥善保管。

避免可能暴露于過多微波能量的注意事項：

- (a) 爐門打開時請勿實施操作，否則您可能會受微波能量的輻射傷害。請勿打破或損壞安全連鎖裝置。
- (b) 請勿在微波爐前面和爐門之間放置任何物體，或使污物或清潔劑殘留聚積在密封表面。
- (c) 警告：若爐門或爐門封條已損壞，在專業人員維修之前請勿操作。

附錄：

若設備沒有得到很好的清潔維護，其表面可能會受到侵蝕，從而影響設備的使用壽命并導致危險狀態。

規格

型號：	MM250 MM260X	MM200 MM220X
額定電壓：	230V~50Hz	230V~50Hz
額定輸入功率（微波）：	1270W	1270W
額定輸出功率（微波）：	800W	800W
額定燒烤功率：	1000W	

安全方面的注意事項

使用設備時，為減少火災、觸電、對人造成的傷害或暴露于過量微波能量的危險，請遵守以下基本注意事項：

1. 在微波爐中加熱飲品或清水時，即使過度加熱，甚至超過沸點，也未必會出現沸騰的氣泡，但是液體却可能會突然溢出造成燙傷。為避免發生上述情況，請遵守以下幾點：
 - 1) 避免使用窄小瓶頸的容器。
 - 2) 將容器放進爐內之前請先攪動液體，並將茶匙留在容器內。
 - 3) 流質食物加熱後，請放置一段時間再加以攪動方才小心將容器從微波爐中取出。
2. 警告：除專業人員外，任何擅自進行涉及到外罩拆卸的服務或維修操作均可能帶來危險。該外罩可保護使用者免受暴露于微波帶來的危害。
3. 警告：只有在已經提供充分的指導以至於兒童能夠採用安全的方法使用微波爐，並且明白不正確的使用會造成為危險時，才可允許兒童在無人監控的情況下使用微波爐。
4. 警告：在組合模式下操作時，由于加熱會產生高溫，故小孩只能在大人監督下才可使用該微波爐。（僅限于燒烤系列）
5. 請使用適合于微波爐中使用的器皿。
6. 微波爐需定期清洗，任何殘留的食物均需清理乾淨。
7. 閱讀并遵從“避免可能暴露于過多微波能量的注意事項”。
8. 當在塑料或紙質容器內加熱食物時，請密切注意微波爐，因為有著火的可能。
9. 若發現有冒烟，請關閉或拔掉微波爐電源，保持爐門關閉狀態以便熄滅火焰。
10. 請勿過度烹調食物。
11. 請勿將爐腔用作儲存之用。請勿在微波爐內存放食物，比如麵包或餅乾等。
12. 將紙質或塑料容器/袋放入微波爐之前，請將金屬扎帶和金屬提手取下。
13. 請按照隨附安裝說明安裝或放置微波爐。
14. 微波爐不能用來加熱帶殼的鮮蛋或已煮熟的蛋，因為它們在用微波加熱時甚至在加熱之後可能會發生爆炸。
15. 請勿將微波爐用作說明書規定以外的其他用途。勿在器具內使用腐蝕性化學藥品或氣體。此微波爐專為加熱食物而設計，并不適于工業或實驗用途。
16. 若電源軟綫損壞，則必須由製造商、服務代理或同樣具有資格的專業人員更換，以避免產生危害。
17. 切勿將微波爐放置在室外或在室外使用。
18. 請勿在有水附近、潮濕的地下室或泳池附近操作。
19. 器具操作時，可接觸表面的溫度可能較高。使用時表面溫度會變得很燙。請將軟綫放置遠離熱表面，請勿覆蓋微波爐的任何通風口。

20. 請勿將軟綫懸挂于桌子或櫃檯的邊緣。
21. 未保持微波爐清潔可能會導致表面受到惡化損壞，影響器具的使用壽命并可能導致危險的情況發生。
22. 在嬰兒食物器皿中加熱食物或流質食物後，在喂食之前請先將食物加以攪拌并檢查溫度，確保熱力分布均勻和避免燙傷或灼傷的危險。確保加熱之前已將蓋子與奶嘴取出。
23. 飲料經微波加熱後會引起延時沸騰，因此要小心處理盛飲料的容器，以免燙傷。
24. 此器具不適用於身體、感官或精神上有缺陷或缺少經驗和知識的人（包括兒童）使用，除非在對他們安全負責的人的監督或指導下使用。
25. 兒童使用時需有大人監督，確保他們不會將微波爐當作玩具玩。
26. 微波爐不可置于櫥櫃內，已在櫥櫃內測試過除外。
27. 微波爐不可通過外部計時器或遙控系統進行操作。
28. 使用時可接觸部位可能會變燙。小孩應遠離蒸汽。請勿使用清潔器。
29. 器具背面需靠牆放置。

減少對人造成傷害的危險

接地安裝

危險

觸電危險

觸摸某些內部元件可能會造成嚴重的個人傷害甚至造成死亡。請勿擅自拆卸。

警告

觸電危險

接地的不正確使用可導致觸電。器具在正確安裝和接地之前請勿將其插入電源插座。

清洗

清洗之前，確保微波爐已與電源斷開。

1. 使用稍微濕點的濕布後，清潔微波爐內部。
2. 在肥皂水中用常規方法清洗附件。
3. 門框和封口以及附近部件變髒時，需用濕布小心清洗。

該器具必須接地。如果發生綫路短路，接地可通過為電流提供排電綫減少觸電的危險。器具附帶有一條具有接地插頭的接地綫的軟綫。該插頭需插入已正確安裝和接地的電源插座。

器具必須進行接地。不遵守該要求而造成對人、動物或物體的任何傷害，製造商概不負責。

若對接地說明不完全明白或懷疑器具是否正確接地，可諮詢合格電工或修護人員。

由于用戶沒有遵守說明書的指示而造成的問題，製造商概不負責。

BS 三扁插頭



器皿

注意

個人傷害危險

除專業人員外，任何擅自進行涉及到外罩拆卸的服務或維修操作均可能帶來危險。該外罩可保護使用者免受暴露于微波能量帶來的危害。

微波爐中可使用的材料

參閱“微波爐中可使用與應避免的材料”的說明。其中可能有某些非金屬器皿不可用于微波加熱。如有疑問，可按以下步驟對器皿進行測試。

器皿測試：

1. 在微波專用容器中加入一杯冷水（250 毫升）以及測試器皿
2. 以最大火力烹調 1 分鐘
3. 小心觸摸下器皿。如果空器皿變熱，請勿將其用于微波烹調。
4. 烹調時間請勿超過 1 分鐘。

器皿	備注
鋁箔	僅作保護之用。可將面積少於玻璃轉盤一半的錫箔覆蓋于肉或家禽的較薄部位，以防止過度烹調。如果過于接近爐壁，可能造成錫箔擊穿。錫箔需離爐壁至少 1 英寸(2.5 厘米)。
燒烤盤	遵從廠商說明。燒烤盤底部必須在轉盤上面至少 3/16 英寸（5 毫米）。不正確的使用可能會使轉盤破裂。
餐具	僅限于微波安全型餐具。遵從廠商說明。請勿使用破裂或有缺口的盤或碟。
玻璃瓶	任何情況下均應取下蓋子。僅用于加熱食物至剛熱狀態。大多數玻璃瓶并不耐熱，可能會破裂。
玻璃器具類	僅限于耐熱微波爐專用玻璃器具。確保無金屬包邊。請勿使用破裂或有缺口的盤或碟。
烤箱袋	遵從廠商說明。請勿用金屬綫系緊，預留一些縫隙以便蒸汽溢出。
紙盤或紙杯	僅用于短時間的烹飪或加熱。烹飪時請勿離開。
生活用紙	用于覆蓋于食物進行重新加熱和吸收脂肪。僅用于有人監控的短時間烹飪。
羊皮紙	用于覆蓋食物，防止食物發生潑濺或在蒸汽加熱時用作包裹
塑料	僅限于微波安全型。遵從廠商說明。必須標示“微波安全”。某些塑料容器在裏面的食物變熱時即變軟。可煮袋和密封包裝的塑料袋須按包裝上的指示切開、刺破或開孔。
塑料保鮮膜	僅限于微波安全型。用于在烹調過程中包裹食物，以保持水分。請勿將塑料保鮮膜接觸食物。
溫度計	僅限于微波安全型。（肉和糖果溫度計）
食品蠟紙	用于覆蓋食物，防止食物發生潑濺和保持水分

微波爐中應避免的材料

器皿	備注
鋁盤	可能引起擊穿。將食物轉移至微波專用盤。
帶金屬提手的食品紙盒	可能引起擊穿。將食物轉移至微波專用盤。
金屬或金屬包邊的器皿	金屬會隔離微波能量接觸食物。金屬包邊會引起擊穿。
金屬扎口綫	可能引起擊穿和引起爐內著火。
紙袋	可能引起爐內著火。
塑料泡沫	塑料泡沫暴露于高溫時可能會溶化或污染裏面的液體。
木材	木材在微波爐中使用時會燒幹，可能會裂開或破裂。

設置微波爐

各部件和附件的名稱

從紙箱和爐腔中取下微波爐和所有材料。

微波爐隨附有以下附件：

- 玻璃托盤 1
- 轉盤圈 1
- 說明書 1

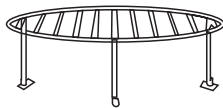
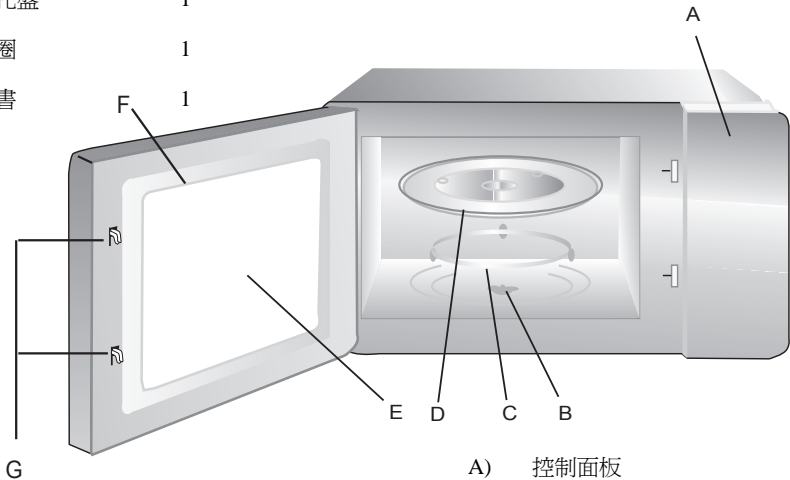

燒烤架（僅用于MM250/MM260X）

- A) 控制面板
- B) 轉盤軸
- C) 轉盤圈
- D) 玻璃托盤
- E) 觀察窗口
- F) 爐門部件
- G) 安全連鎖裝置
- H) 燒烤架（僅適用於燒烤系列）

轉盤安裝

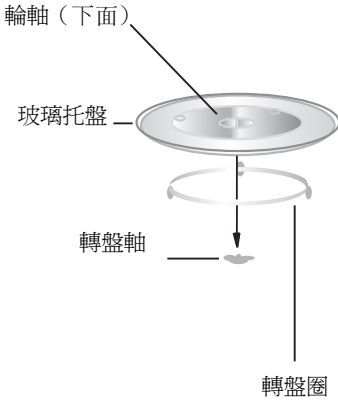

- 請勿倒置玻璃托盤。玻璃托盤須能輕鬆轉動。
- 烹飪過程中玻璃托盤和轉盤圈都必須使用。
- 烹飪時所有食物和裝食物的容器都應放置于玻璃托盤上面。
- 若玻璃托盤或轉盤圈破裂或損壞，請聯繫最近的授權服務中心。

工作臺面安裝

取下所有包裝材料和附件。

檢查微波爐是否有損壞，如凹痕或破損的爐門等。如果微波爐有損壞，請勿繼續安裝。

烤箱：取下烤箱內部表面的任何保護膜。請勿弄掉依附在爐腔上用于保護磁電管的淺褐色雲母。

安裝

- 選擇一個進氣口和/或出氣口均有足夠空間的水平面。

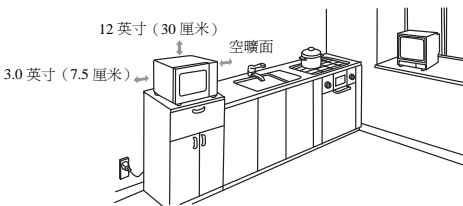

- 阻塞進氣口和/或出氣口會損害微波爐。
- 微波爐應盡量遠離收音機和電視擺放。微波爐工作時會對你的收音機或電視的接收信號造成干擾。

- 請將微波爐插入標準家用電源。確保電源的電壓和頻率與銘牌標籤上標示的電壓和頻率相同。

微波爐與任何相鄰牆面間的最小空隙要求為 3.0 英寸 (7.5 厘米)。其中一個面必須為空曠面。

- 微波爐上面至少留 12 英寸 (30 厘米) 的空隙。
- 請勿從微波爐底部取下支架。

警告：請勿將微波爐安裝于爐灶面或其他發熱電器上。若安裝于熱源附近或上面，微波爐可能會受到損壞，保證書將無效。操作過程中可接觸表面可能會變燙



設備在操作時，燒烤架上可接觸表面的溫度可能很高。

控制面板和功能 (适用于 MM250/MM260X)

操作指引

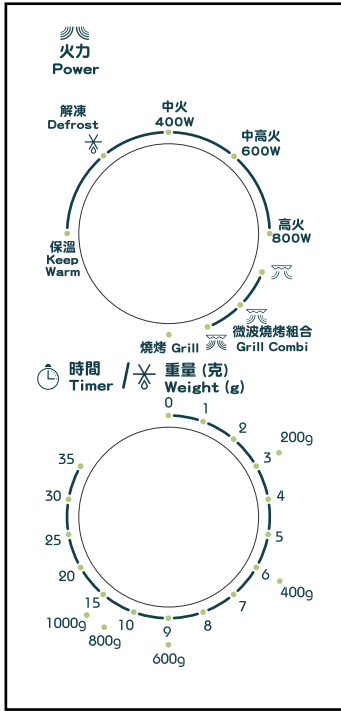

1. 旋轉火力旋鈕設置需要的火力檔位
2. 旋轉時間旋鈕設置需要的烹調時間
3. 在火力檔位和烹調時間設置后，微波爐會自動開始工作
4. 烹調時間到達時，微波爐會發出“叮”的一聲提示結束
5. 在不使用的時候，要將時間設置為“0”

功能/ 火力	火力輸出	應用
Low (保溫)	17% 微波火力	軟化雪糕
Med.Low(Defrost) (解凍 Defrost)	33% 微波火力	燉湯，牛肉解凍
Med. (中火 400W)	55% 微波火力	燉肉，魚
Med. High (中高火 600W)	77% 微波火力	米飯，魚，雞，肉類
High (高火 800W)	100% 微波火力	加熱，牛奶，煮開水，蔬菜，飲料

功能/ 火力	火力輸出	應用
組合.1 (燒烤)	80% 燒烤, 20% 微波	烤腸，羊肉，烤肉串，海鮮，牛排
組合.2 (燒烤)	70% 燒烤, 30% 微波	雞塊，雞胸肉，豬排
組合.3 (燒烤)	60% 燒烤, 40% 微波	整雞
燒烤 (燒烤)	100% 燒烤	麵包片，其它片狀食物

注意：當從微波爐中取出食物時，要將時間旋鈕旋至 0 處，從而確保微波火力關閉。如果不這樣做，並且使微波爐空轉，可能導致微波爐過熱，從而損壞磁控管。

控制面板和功能（适用于 MM100/MM120X） 操作指引

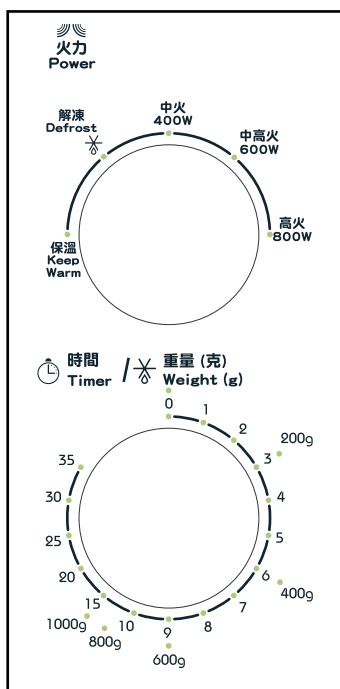

1. 旋轉火力旋鈕設置需要的火力檔位
2. 旋轉時間旋鈕設置需要的烹調時間
3. 在火力檔位和烹調時間設置后，微波爐會自動開始工作
4. 烹調時間到達時，微波爐會發出“叮”的一聲提示結束
5. 在不使用的時候，要將時間設置為“0”

功能/ 火力	火力輸出	應用
Low (保溫)	17% 微波火力	軟化雪糕
Med.Low(Defrost) (解凍 Defrost)	33% 微波火力	燉湯，牛肉解凍
Med. (中火 400W)	55% 微波火力	燉肉，魚
Med. High (中高火 600W)	77% 微波火力	米飯，魚，雞，肉類
High (高火 800W)	100% 微波火力	加熱，牛奶，煮開水，蔬菜，飲料

注意：當從微波爐中取出食物時，要將時間旋鈕旋至 0 處，從而確保微波火力關閉。如果不這樣做，並且使微波爐空轉，可能導致微波爐過熱，從而損壞磁控管。

維修保養

故障診斷與維修

下列情況均屬正常	
微波爐干擾電視信號接收	微波爐工作時，收音機和電視的信號接收可能會受到干擾。同樣會對小家電如混合器、真空吸塵器和電風扇造成干擾。均屬正常現象。
微波爐燈光暗弱	低火力烹調時，微波爐燈管可能會變暗弱，屬正常現象。
蒸汽積聚爐門，有熱風從排氣口排出	烹調時，食物中會冒出蒸汽。大多數會從排氣口排出，但一些可能會聚集在較冷的地方，比如爐門。均屬正常現象。
爐內沒有食物時微波爐意外開始操作	禁止爐內無任何食物時操作該微波爐。此操作非常危險，很可能會損壞微波爐。

故障	可能原因	解決方法
微波爐無法啓動	(1) 電源綫沒有插緊	拔下插頭，待 10 秒鐘後重插
	(2) 保險絲燒斷或斷路器工作	更換保險絲或重新設置斷路器(由本公司專業人員負責維修)
	(3) 電源插座有問題	用其他電器測試插座是否有問題
微波爐不加熱	(4) 爐門未關好	關好爐門
微波爐運行時玻璃轉盤會發出響聲	(5) 滾筒支托和微波爐底變髒	參考“微波爐的維修保養”對不潔的部件進行清洗



產品或產品隨附文件上的此標志表示本產品不可視為家庭廢棄物，相反需將其交至相應的回收點對電氣和電子設備進行回收。

如日後需要棄置，請遵循本地的廢物棄置條例。

有關產品處理，恢復使用和回收的詳細數據，請聯繫本地政府機構、家庭廢棄物處理服務機構或購買本產品的商店。

棄置前請切斷電源綫，使本產品不能連接電源。

Instructions for use

**MM260X / MM250
MM200 / MM220X**

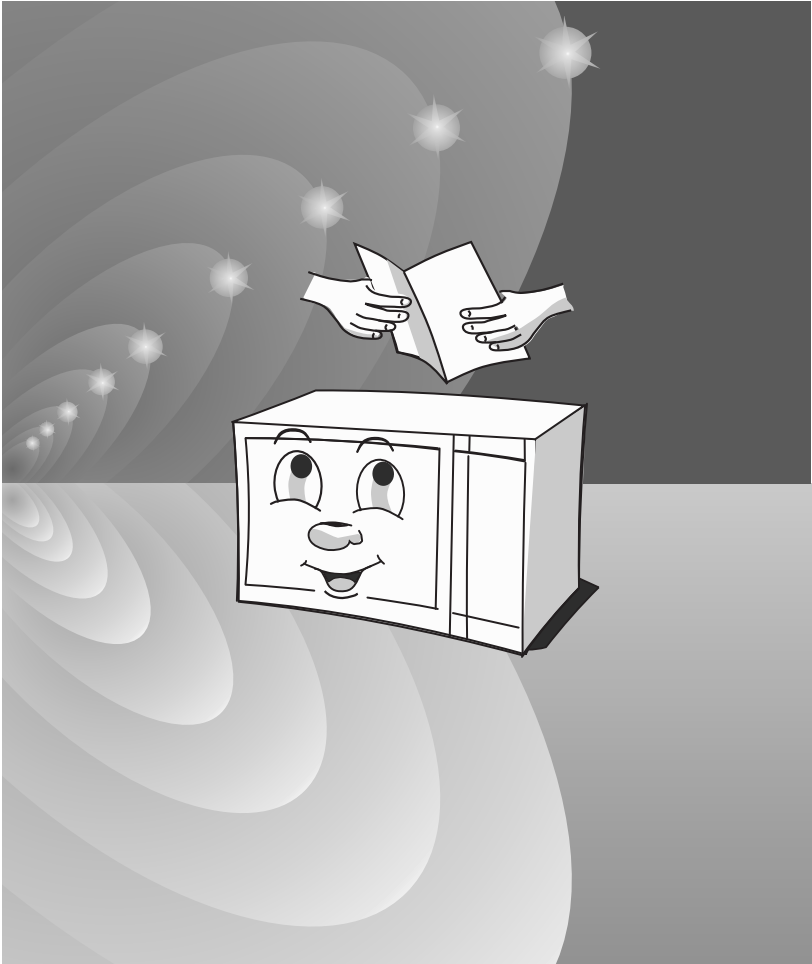

 **Whirlpool**[®]
HOME APPLIANCES

Microwave Oven

INSTRUCTION MANUAL

**MODEL : MM260X/MM250
MM200/MM220X**

Read these instructions carefully before using your microwave oven, And keep it carefully.

PRECAUTIONS TO AVOID POSSIBLE EXPOSURE TO EXCESSIVE MICROWAVE ENERGY

- (a) Do not attempt to operate this oven with the door open since this can result in harmful exposure to microwave energy. It is important not to break or tamper with the safety interlocks.
- (b) Do not place any object between the oven front face and the door or allow soil or cleaner residue to accumulate on sealing surfaces.
- (c) **WARNING:** If the door or door seals are damaged, the oven must not be operated until it has been repaired by a competent person.

ADDENDUM

If the apparatus is not maintained in a good state of cleanliness, its surface could be degraded and affect the lifespan of the apparatus and lead to a dangerous situation.

Specifications

Model:	MM250 MM260X	MM200 MM220X
Rated Voltage:	230V~ 50Hz	230V~ 50Hz
Rated Input Power(Microwave):	1270 W	1270 W
Rated Output Power(Microwave):	800 W	800 W
Rated Input Power(Grill):	1000 W	

IMPORTANT SAFETY INSTRUCTIONS

WARNING

To reduce the risk of fire, electric shock, injury to persons or exposure to excessive microwave oven energy when using your appliance, follow basic precautions, including the following:

1. Warning: Liquids and other foods must not be heated in sealed containers since they are liable to explode.
 - a) Avoid to use narrow bottle.
 - b) Stir the liquid before cooking.
Put the spoon in the container when cooking.
 - c) Liquid shall be standed for a period time and stirred after cooking.
2. Warning: It is hazardous for anyone other than a competent person to carry out any service or repair operation that involves the removal of a cover which gives protection against exposure to microwave energy.
3. Warning: Only allow children to use the oven without supervision when adequate instructions have been given so that the child is able to use the oven in a safe way and understand the hazards of improper use.
4. Warning: When the appliance is operated in the combination mode, children should only use the oven under adult supervision due to the temperatures generated. (only for grill series)
5. Only use utensils suitable for use in microwave ovens.
6. The oven should be cleaned regularly and any food deposits should be removed.
7. Read and follow the specific: "PRECAUTIONS TO AVOID POSSIBLE EXPOSURE TO EXCESSIVE MICROWAVE ENERGY".
8. When heating food in plastic or paper containers, keep an eye on the oven due to the possibility of ignition.
9. If smoke is observed, switch off or unplug the appliance and keep the door closed in order to stifle any flames.
10. Do not overcook food.
11. Do not use the oven cavity for storage purposes. Do not store items, such as bread, cookies, etc. inside the oven.
12. Remove wire twist-ties and metal handles from paper or plastic containers/bags before placing them in the oven.
13. Install or locate this oven only in accordance with the installation instructions provided.
14. Eggs in the shell and whole hard-boiled eggs should not be heated in microwave ovens since they may explode, even after microwave heating has ended.
15. Use this appliance only for its intended uses as described in manual. Do not use corrosive chemicals or vapors in this appliance. This oven is especially designed to heat. It is not designed for industrial or laboratory use.
16. If the supply cord is damaged, it must be replaced by the manufacturer, its service agent or similarly qualified persons in order to avoid a hazard.
17. Do not store or use this appliance outdoors.
18. Do not use this oven near water, in a wet basement or near a swimming pool.
19. The temperature of accessible surfaces may be high when the appliance is operating. Keep cord away from heated surface, and do not cover any vents on the oven.
20. Do not let cord hang over edge of table or counter.
21. Failure to maintain the oven in a clean condition could lead to deterioration of the surface that could adversely affect the life of the appliance and possibly result in a hazardous situation.
22. The contents of feeding bottles and baby food jars shall be stirred or shaken and the temperature checked before consumption, in order to avoid burns.
23. Microwave heating of beverages can result in delayed eruptive boiling, therefore care must be taken when handling the container.

- 24. The appliance is not intended for use by persons (including children) with reduced physical, sensory or mental capabilities, or lack of experience and knowledge, unless they have been given supervision or instruction concerning use of the appliance by a person responsible for their safety.
- 25. Children should be supervised to ensure that they do not play with the appliance.
- 26. The microwave oven shall not be placed in a cabinet unless it has been tested in a cabinet.
- 27. Appliances are not intended to be operated by means of an external timer or separate remote-control system.
- 28. The door or the outer surface may get hot when the appliance is operating.
- 29. The rear surface of appliance shall be placed against a wall.

To Reduce the Risk of Injury to Persons

Grounding Installation

DANGER

Electric Shock Hazard

Touching some of the internal components can cause serious personal injury or death. Do not disassemble this appliance.

This appliance must be grounded. In the event of an electrical short circuit, grounding reduces the risk of electric shock by providing an escape wire for the electric current. This appliance is equipped with a cord having a grounding wire with a grounding plug. The plug must be plugged into an outlet that is properly installed and grounded.

WARNING

Electric Shock Hazard

Improper use of the grounding can result in electric shock. Do not plug into an outlet until appliance is properly installed and grounded.

Consult a qualified electrician or serviceman if the grounding instructions are not completely understood or if doubt exists as to whether the appliance is properly grounded.

CLEANING

Be sure to unplug the appliance from the power supply.

1. Clean the inside of the oven after using with a slightly damp cloth.
2. Clean the accessories in the usual way in soapy water.
3. The door frame and seal and neighbouring parts must be cleaned carefully with a damp cloth when they are dirty.



UTENSILS

See the instructions on "Materials you can use in microwave oven or to be avoided in microwave oven." There may be certain non-metallic utensils that are not safe to use for microwaving. If in doubt, you can test the utensil in question following the procedure below.

CAUTION

Personal Injury Hazard

It is hazardous for anyone other than a competent person to carry out any service or repair operation that involves the removal of a cover which gives protection against exposure to microwave energy.

Utensil Test:

1. Fill a microwave-safe container with 1 cup of cold water (250ml) along with the utensil in question.
2. Cook on maximum power for 1 minute.
3. Carefully feel the utensil. If the empty utensil is warm, do not use it for microwave cooking.
4. Do not exceed 1 minute cooking time.

Materials you can use in microwave oven

Utensils	Remarks
Aluminum foil	Shielding only. Smooth pieces with smaller size than half of glass turntable can be used to cover thin parts of meat or poultry to prevent overcooking. Arcing can occur if foil is too close to oven walls. The foil should be at least 1 inch (2.5cm) away from
Browning dish	Follow manufacturer's instructions. The bottom of browning dish must be at least 3/16 inch (5mm) above the turntable. Incorrect usage may cause the turntable to break.
Dinnerware	Microwave-safe only. Follow manufacturer's instructions. Do not use cracked or chipped dishes.
Glass jars	Always remove lid. Use only to heat food until just warm. Most glass jars are not heat resistant and may break.
Glassware	Heat-resistant oven glassware only. Make sure there is no metallic trim. Do not use cracked or chipped dishes.
Oven cooking bags	Follow manufacturer's instructions. Do not close with metal tie. Make slits to allow steam to escape.
Paper plates and cups	Use for short-term cooking/warming only. Do not leave oven unattended while cooking.
Paper towels	Use to cover food for reheating and absorbing fat. Use with supervision for a short-term cooking only.
Parchment paper	Use as a cover to prevent splattering or a wrap for steaming.
Plastic	Microwave-safe only. Follow the manufacturer's instructions. Should be labeled "Microwave Safe". Some plastic containers soften, as the food inside gets hot. "Boiling bags" and tightly closed plastic bags should be slit, pierced or vented as directed by package.
Plastic wrap	Microwave-safe only. Use to cover food during cooking to retain moisture. Do not allow plastic wrap to touch food.
Thermometers	Microwave-safe only (meat and candy thermometers).
Wax paper	Use as a cover to prevent splattering and retain moisture.

Materials to be avoided in microwave oven

Utensils	Remarks
Aluminum tray	May cause arcing. Transfer food into microwave-safe dish.
Food carton with metal handle	May cause arcing. Transfer food into microwave-safe dish.
Metal or metal-trimmed utensils	Metal shields the food from microwave energy. Metal trim may cause arcing.
Metal twist ties	May cause arcing and could cause a fire in the oven.
Paper bags	May cause a fire in the oven.
Plastic foam	Plastic foam may melt or contaminate the liquid inside when exposed to high temperature.
Wood	Wood will dry out when used in the microwave oven and may split or crack.

SETTING UP YOUR OVEN

Names of Oven Parts and Accessories

Remove the oven and all materials from the carton and oven cavity.

Your oven comes with the following accessories:

Glass tray	1
Turntable ring assembly	1
Instruction Manual	1

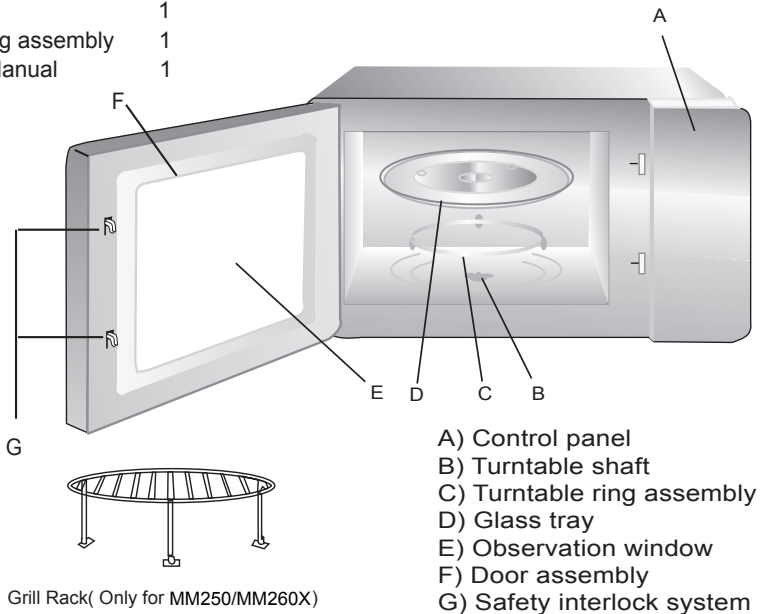

Turntable Installation

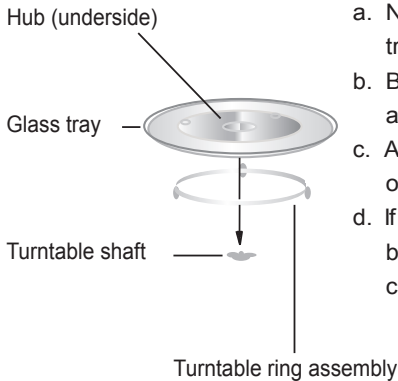

- Never place the glass tray upside down. The glass tray should never be restricted.
- Both glass tray and turntable ring assembly must always be used during cooking.
- All food and containers of food are always placed on the glass tray for cooking.
- If glass tray or turntable ring assembly cracks or breaks, contact your nearest authorized service center.

Countertop Installation

Remove all packing material and accessories. Examine the oven for any damage such as dents or broken door. Do not install if oven is damaged.

Cabinet: Remove any protective film found on the microwave oven cabinet surface. Do not remove the light brown Mica cover that is attached to the oven cavity to protect the magnetron.

Installation

- Select a level surface that provide enough open space for the intake and/or outlet vents.

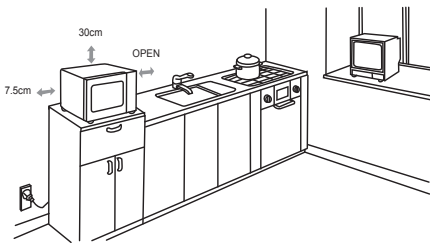

A minimum clearance of 7.5cm is required between the oven and any adjacent walls. One side must be open.

- Leave a minimum clearance of 30cm above the oven.
- Do not remove the legs from the bottom of the oven.

- Blocking the intake and/or outlet openings can damage the oven.
 - Place the oven as far away from radios and TV as possible. Operation of microwave oven may cause interference to your radio or TV reception.
- Plug your oven into a standard household outlet. Be sure the voltage and the frequency is the same as the voltage and the frequency on the rating label.

WARNING: Do not install oven over a range cooktop or other heat-producing appliance. If installed near or over a heat source, the oven could be damaged and the warranty would be void.

The accessible surface may be hot during operation.



OPERATION(for MM250/MM260X)

Control Panel and Features Operation Instructions

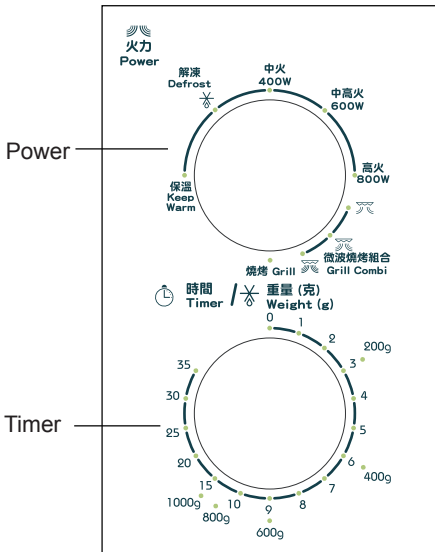

1. To set cooking power by turning the power knob to desired level.
2. To set the time of cooking by turning the timer knob to desired time per your food cooking guide.
3. The microwave oven will automatically start cooking after power level and time are set.
4. After the cooking time is up, the unit will "Dong" to stop.
5. If the unit is not in use, always set time to "0".

Function/Power	Output	Application
Keep Warm	17% micro.	Soften ice cream
Defrost	33% micro.	Soup stew, soften butter or defrost
400W	55% micro.	Stew, fish
600W	77% micro.	Rice, fish, chicken, ground meat
800W	100% micro.	Reheat, milk, boil water, vegetables, beverage

Function/Power	Output	Application
Combi.1	80% grill 20% micro.	Sausage, Lamb, Kabobs, Seafood, Steak
Combi.2	70% grill 30% micro.	Chicken pieces, Chicken breasts, Pork chops
Combi.3	60% grill 40% micro.	Whole chicken
Grill	100% grill	Baken bread, Slice food

Notice: When removing food from the oven, please ensure that the oven power is switched off by turning the timer switch to 0 (zero). Failure to do so, and operating the microwave oven without food in it, can result in overheating and damage to the magnetron.

OPERATION(for MM200/MM220X)

Control Panel and Features

Operation Instructions

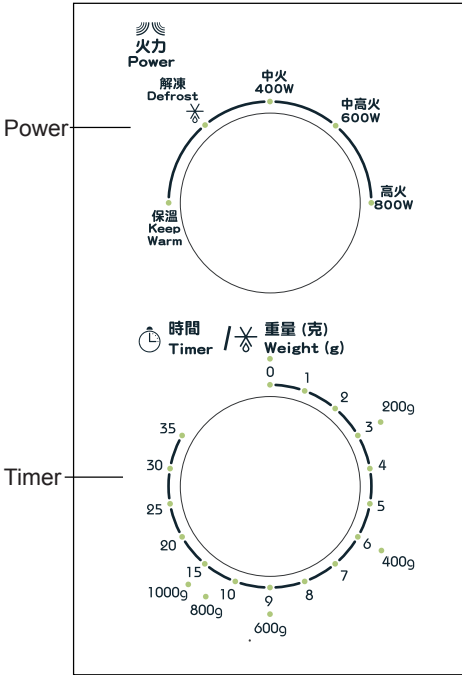

1. To set cooking power by turning the power knob to desired level.
2. To set the time of cooking by turning the timer knob to desired time per your food cooking guide.
3. The microwave oven will automatically start cooking after power level and time are set.
4. After the cooking time is up, the unit will "Dong" to stop.
5. If the unit is not in use, always set time to "0".

Function/Power	Output	Application
Keep Warm	17% micro.	Soften ice cream
Defrost 	33% micro.	Soup stew, soften butter or defrost
400W	55% micro.	Stew, fish
600W	77% micro.	Rice, fish, chicken, ground meat
800W	100% micro.	Reheat, milk, boil water, vegetables, beverage

Notice: When removing food from the oven, please ensure that the oven power is switched off by turning the timer switch to 0 (zero). Failure to do so, and operating the microwave oven without food in it, can result in overheating and damage to the magnetron.

Trouble shooting

Normal	
Microwave oven interfering TV reception	Radio and TV reception may be interfered when microwave oven operating. It is similar to the interference of small electrical appliances, like mixer, vacuum cleaner, and electric fan. It is normal.
Dim oven light	In low power microwave cooking, oven light may become dim. It is normal.
Steam accumulating on door, hot air out of vents	In cooking, steam may come out of food. Most will get out from vents. But some may accumulate on cool place like oven door. It is normal.
Oven started accidentally with no food in.	It is forbidden to run the unit without any food inside. It is very dangerous.

Trouble	Possible Cause	Remedy
Oven can not be started.	(1) Power cord not plugged in tightly.	Unplug. Then plug again after 10 seconds.
	(2) Fuse blowing or circuit breaker works.	Replace fuse or reset circuit breaker (repaired by professional personnel of our company)
	(3) Trouble with outlet.	Test outlet with other electrical appliances.
Oven does not heat.	(4) Door not closed well.	Close door well.
Glass turntable makes noise when microwave oven operates	(5) Dirty roller rest and oven bottom.	Refer to "Maintenance of Microwave" to clean dirty parts.



According to Waste of Electrical and Electronic Equipment (WEEE) directive, WEEE should be separately collected and treated. If at any time in future you need to dispose of this product please do NOT dispose of this product with household waste. Please send this product to WEEE collecting points where available.

PN:261800311434