

用户手册

MWH 303

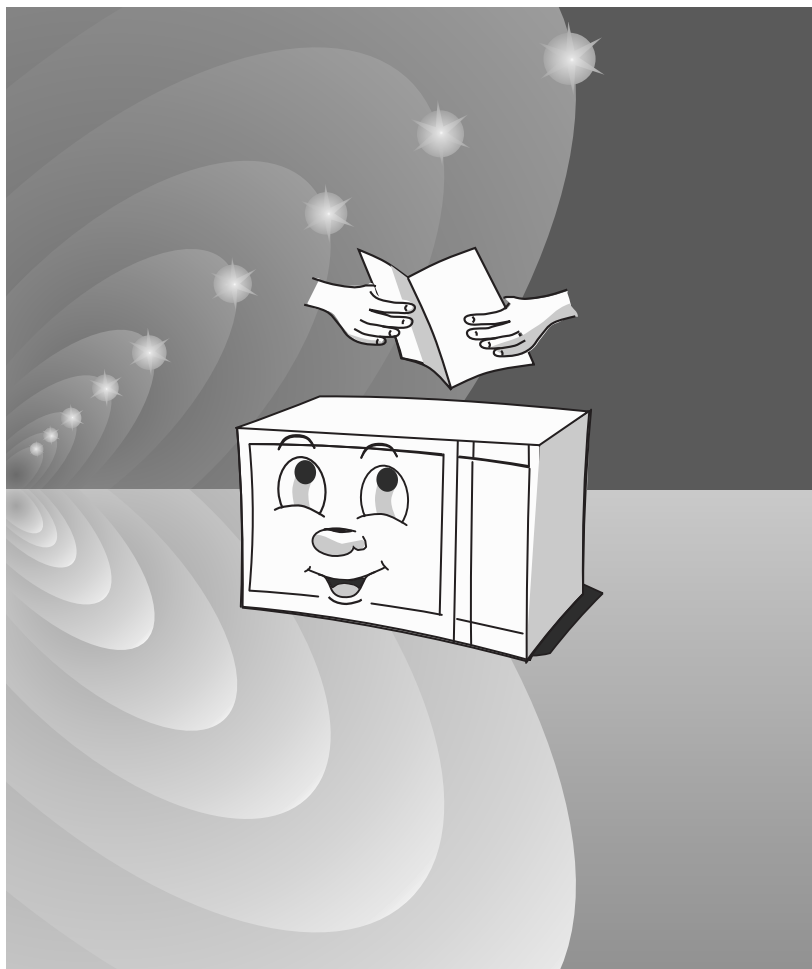

 **Whirlpool**[®]
HOME APPLIANCES

微波爐

用戶手冊

型號：MWH 303

使用微波爐之前請仔細閱讀用戶手冊，并請妥善保管。

避免可能暴露于過多微波能量的注意事項：

- (a) 爐門打開時請勿實施操作，否則您可能會受微波能量的輻射傷害。請勿打破或損壞安全連鎖裝置。
- (b) 請勿在微波爐前面和爐門之間放置任何物體，或使污物或清潔劑殘留聚積在密封表面。
- (c) 警告：若爐門或爐門封條已損壞，在專業人員維修之前請勿操作。

附錄：

若設備沒有得到很好的清潔維護，其表面可能會受到侵蝕，從而影響設備的使用壽命并導致危險狀態。

規格

型號：	MWH 303
額定電壓：	230V~50Hz
額定輸入功率（微波）：	1270W
額定輸出功率（微波）：	800W

安全方面的注意事項

使用設備時，為減少火災、觸電、對人造成的傷害或暴露于過量微波能量的危險，請遵守以下基本注意事項：

1. 在微波爐中加熱飲品或清水時，即使過度加熱，甚至超過沸點，也未必會出現沸騰的氣泡，但是液體却可能會突然溢出造成燙傷。為避免發生上述情況，請遵守以下幾點：

- 1) 避免使用窄小瓶頸的容器。
- 2) 將容器放進爐內之前請先攪動液體，並將茶匙留在容器內。
- 3) 流質食物加熱後，請放置一段時間再加以攪動方才小心將容器從微波爐中取出。

2.警告：除專業人員外，任何擅自進行涉及到外罩拆卸的服務或維修操作均可能帶來危險。該外罩可保護使用者免受暴露于微波帶來的危害。

3.警告：只有在已經提供充分的指導以至于兒童能夠採用安全的方法使用微波爐，並且明白不正確的使用會造成為危險時，才可允許兒童在無人監控的情況下使用微波爐。

4.警告：在組合模式下操作時，由于加熱會產生高溫，故小孩只能在大人監督下才可使用該微波爐。（僅限于燒烤系列）

5.請使用適合于微波爐中使用的器皿。

6.微波爐需定期清洗，任何殘留的食物均需清理乾淨。

7.閱讀并遵從“避免可能暴露于過多微波能量的注意事項”。

8.當在塑料或紙質容器內加熱食物時，請密切注意微波爐，因為有著火的可能。

9.若發現有冒烟，請關閉或拔掉微波爐電源，保持爐門關閉狀態以便熄滅火焰。

10.請勿過度烹調食物。

11.請勿將爐腔用作儲存之用。請勿在微波爐內存放食物，比如麵包或餅乾等。

12.將紙質或塑料容器/袋放入微波爐之前，請將金屬扎帶和金屬提手下取。

13.請按照隨附安裝說明安裝或放置微波爐。

14.微波爐不能用來加熱帶殼的鮮蛋或已煮熟的蛋，因為它們在用微波加熱時甚至在加熱之後可能會發生爆炸。

15.請勿將微波爐用作說明書規定以外的其他用途。勿在器具內使用腐蝕性化學藥品或氣體。此微波爐專為加熱食物而設計，并不適用于工業或實驗用途。

16.若電源軟綫損壞，則必須由製造商、服務代理或同樣具有資格的專業人員更換，以避免產生危害。

17.切勿將微波爐放置在室外或在室外使用。

18.請勿在有水附近、潮濕的地下室或泳池附近操作。

19.器具操作時，可接觸表面的溫度可能較高。使用時表面溫度會變得很燙。請將軟綫放置遠離熱表面，請勿覆蓋微波爐的任何通風口。

20. 請勿將軟綫懸挂于桌子或櫃檯的邊緣。
21. 未保持微波爐清潔可能會導致表面受到惡化損壞，影響器具的使用壽命并可能導致危險的情況發生。
22. 在嬰兒食物器皿中加熱食物或流質食物後，在喂食之前請先將食物加以攪拌并檢查溫度，確保熱力分布均勻和避免燙傷或灼傷的危險。確保加熱之前已將蓋子與奶嘴取出。
23. 飲料經微波加熱後會引起延時沸騰，因此要小心處理盛飲料的容器，以免燙傷。
24. 此器具不適用於身體、感官或精神上有缺陷或缺少經驗和知識的人（包括兒童）使用，除非在對他們安全負責的人的監督或指導下使用。
25. 兒童使用時需有大人監督，確保他們不會將微波爐當作玩具玩。
26. 微波爐不可置于櫥櫃內，已在櫥櫃內測試過除外。
27. 微波爐不可通過外部計時器或遙控系統進行操作。
28. 使用時可接觸部位可能會變燙。小孩應遠離蒸汽。請勿使用清潔器。
29. 器具背面需靠牆放置。

減少對人造成傷害的危險

接地安裝

危險

觸電危險

觸摸某些內部元件可能會造成嚴重的個人傷害甚至造成死亡。請勿擅自拆卸。

警告

觸電危險

接地的不正確使用可導致觸電。器具在正確安裝和接地之前請勿將其插入電源插座。

清洗

清洗之前，確保微波爐已與電源斷開。

1. 使用稍微濕點的濕布後，清潔微波爐內部。
2. 在肥皂水中用常規方法清洗附件。
3. 門框和封口以及附近部件變髒時，需用濕布小心清洗。

該器具必須接地。如果發生綫路短路，接地可通過為電流提供排電綫減少觸電的危險。器具附帶有一條具有接地插頭的接地綫的軟綫。該插頭需插入已正確安裝和接地的電源插座。

器具必須進行接地。不遵守該要求而造成對人、動物或物體的任何傷害，製造商概不負責。

若對接地說明不完全明白或懷疑器具是否正確接地，可諮詢合格電工或修護人員。

由于用戶沒有遵守說明書的指示而造成的問題，製造商概不負責。

BS 插頭

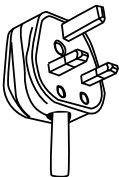

注意

個人傷害危險

除專業人員外，任何擅自進行涉及到外罩拆卸的服務或維修操作均可能帶來危險。該外罩可保護使用者免受暴露于微波能量帶來的危害。

微波爐中可使用的材料

器皿	備注
鋁箔	僅作保護之用。可將面積少於玻璃轉盤一半的鋁箔覆蓋于肉或家禽的較薄部位，以防止過度烹調。如果過于接近爐壁，可能造成鋁箔擊穿。鋁箔需離爐壁至少 1 英寸(2.5 厘米)。
燒烤盤	遵從廠商說明。燒烤盤底部必須在轉盤上面至少 3/16 英寸(5 毫米)。不正確的使用可能會使轉盤破裂。
餐具	僅限于微波安全型餐具。遵從廠商說明。請勿使用破裂或有缺口的盤或碟。
玻璃瓶	任何情況下均應取下蓋子。僅用于加熱食物至剛熟狀態。大多數玻璃瓶并不耐熱，可能會破裂。
玻璃器具類	僅限于耐熱微波爐專用玻璃器具。確保無金屬包邊。請勿使用破裂或有缺口的盤或碟。
烤箱袋	遵從廠商說明。請勿用金屬綫系緊，預留一些縫隙以便蒸汽溢出。
紙盤或紙杯	僅用于短時間的烹飪或加熱。烹飪時請勿離開。
生活用紙	用于覆蓋于食物進行重新加熱和吸收脂肪。僅用于有人監控的短時間烹飪。
羊皮紙	用于覆蓋食物，防止食物發生潑濺或在蒸汽加熱時用作包裹
塑料	僅限于微波安全型。遵從廠商說明。必須標示“微波安全”。某些塑料容器在裏面的食物變熱時即變軟。可煮袋和密封包裝的塑料袋須按包裝上的指示切開、刺破或開孔。
塑料保鮮膜	僅限于微波安全型。用于在烹調過程中包裹食物，以保持水分。請勿將塑料保鮮膜接觸食物。
溫度計	僅限于微波安全型。(肉和糖果溫度計)
食品蠟紙	用于覆蓋食物，防止食物發生潑濺和保持水分

器皿

參閱“微波爐中可使用與應避免的材料”的說明。其中可能有某些非金屬器皿不可用于微波加熱。如有疑問，可按以下步驟對器皿進行測試。

器皿測試：

1. 在微波專用容器中加入一杯冷水（250 毫升）以及測試器皿
2. 以最大火力烹調 1 分鐘
3. 小心觸摸下器皿。如果空器皿變熱，請勿將其用于微波烹調。
4. 烹調時間請勿超過 1 分鐘。

微波爐中應避免的材料

器皿	備注
鋁盤	可能引起擊穿。將食物轉移至微波專用盤。
帶金屬提手的食品紙盒	可能引起擊穿。將食物轉移至微波專用盤。
金屬或金屬包邊的器皿	金屬會隔離微波能量接觸食物。金屬包邊會引起擊穿。
金屬扎口綫	可能引起擊穿和引起爐內著火。
紙袋	可能引起爐內著火。
塑料泡沫	塑料泡沫暴露于高溫時可能會溶化或污染裏面的液體。
木材	木材在微波爐中使用時會燒幹，可能會裂開或破裂。

設置微波爐

各部件和附件的名稱

從紙箱和爐腔中取下微波爐和所有材料。

微波爐隨附有以下附件：

玻璃托盤 1

轉盤圈 1

說明書 1

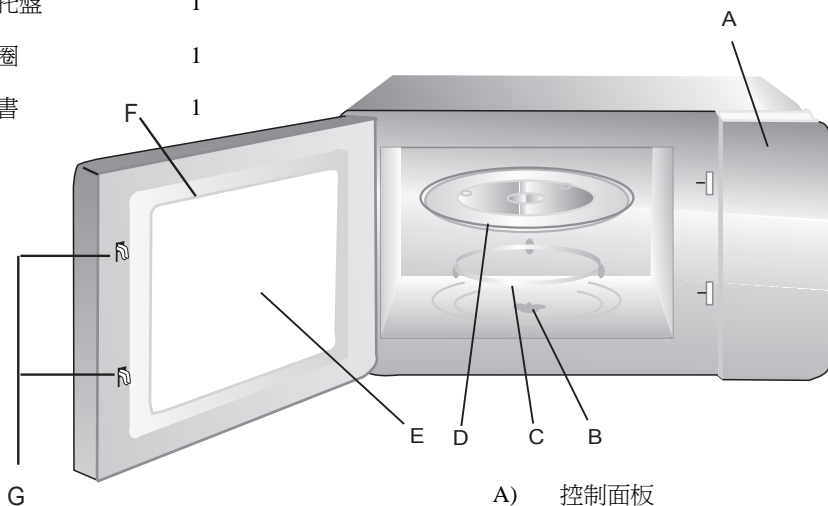

- A) 控制面板
- B) 轉盤軸
- C) 轉盤圈
- D) 玻璃托盤
- E) 觀察窗口
- F) 爐門部件
- G) 安全連鎖裝置

轉盤安裝

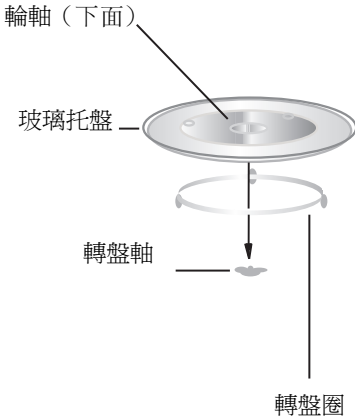

- 請勿倒置玻璃托盤。玻璃托盤須能輕鬆轉動。
- 烹飪過程中玻璃托盤和轉盤圈都必須使用。
- 烹飪時所有食物和裝食物的容器都應放置于玻璃托盤上面。
- 若玻璃托盤或轉盤圈破裂或損壞，請聯繫最近的授權服務中心。

工作臺面安裝

取下所有包裝材料和附件。

檢查微波爐是否有損壞，如凹痕或破損的爐門等。如果微波爐有損壞，請勿繼續安裝。

烤箱：取下烤箱內部表面的任何保護膜。請勿弄掉依附在爐腔上用于保護磁電管的淺褐色雲母。

安裝

1. 選擇一個進氣口和/或出氣口均有足夠空間的水平面。

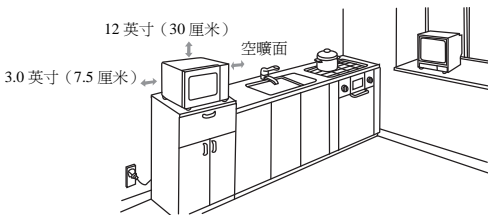

- (3) 阻塞進氣口和/或出氣口會損害微波爐。
- (4) 微波爐應盡量遠離收音機和電視擺放。微波爐工作時會對你的收音機或電視的接收信號造成干擾。

2. 請將微波爐插入標準家用電源。確保電源的電壓和頻率與銘牌標籤上標示的電壓和頻率相同。

微波爐與任何相鄰牆面間的最小空隙要求為 3.0 英寸 (7.5 厘米)。其中一個面必須為空曠面。

- (1) 微波爐上面至少留 12 英寸 (30 厘米) 的空隙。
- (2) 請勿從微波爐底部取下支架。

警告：請勿將微波爐安裝于爐灶面或其他發熱電器上。若安裝于熱源附近或上面，微波爐可能會受到損壞，保證書將無效。操作過程中可接觸表面可能會變燙

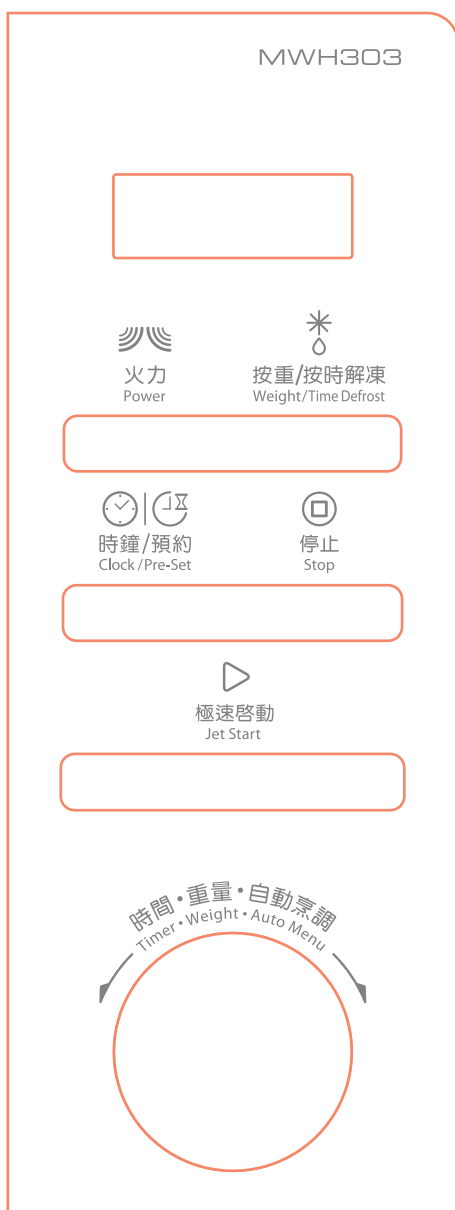

操作

控制面板和功能



1. 時鐘設定：



初始上電，LED 顯示時鐘 0:00，蜂鳴器叫一聲。

- (1) 按“時鐘/預約”鍵，小時位閃爍。
- (2) 旋轉“”，設定小時位，設置範圍 0-23。
- (3) 按“時鐘/預約”鍵，分鐘位閃爍。
- (4) 旋轉“”，設定分鐘位，設置範圍 0-59。
- (5) 按“時鐘/預約”鍵，則“:”開始閃爍，時鐘設定完畢。

注意：1. 上電後，不設置時鐘，則時鐘不計時。

2. 若設定時鐘後，按“停止”鍵，則所設定內容無效，LED 返回到設定前的狀態。

2. 微波烹調

- (1) 按“火力”鍵，LED 閃爍顯示“P100”。
- (2) 繼續按此鍵若干次，選擇微波功率，LED 依次閃爍顯示“P100”、“P 80”、“P 50” … “P 10”。此時也可旋轉“”選擇微波功率。
- (3) 按“極速啟動”鍵確認所選火力。
- (4) 旋轉“”調整烹調時間，烹調時間設定範圍 0:05-95:00。
- (5) 按“極速啟動”鍵開始烹調。

顯示	P100	P80	P50	P30	P10
功率	100%	80%	50%	30%	10%

如要終止微波烹調，可隨時按“停止”鍵。

3. 快速烹調

- (1) 在待機狀態，按“極速啟動”鍵一次，可立即啟動 30 秒、100%微波火力烹調。每按一次可增加 30 秒烹調時間，最長可設定 95 分鐘。
- (2) 在微波烹調過程中，可以按“極速啟動”鍵增加烹調時間。
- (3) 待機狀態下左旋“”，直接選擇烹調時間，按“極速啟動”鍵，烹調開始。烹調火力為 100%微波。

注意：自動功能表和按重解凍烹調過程中，不能按“極速啟動”鍵增加烹調時間。

4. 按重解凍

- (1) 按“按重/按時解凍”鍵一次，LED 顯示“dEF1”。
- (2) 旋轉“”調整解凍重量，重量範圍 100~2000g。
- (3) 按“極速啓動”鍵，解凍開始。



5. 按時解凍

- (1) 按“按重/按時解凍”鍵兩次，LED 顯示“dEF2”。
- (2) 旋轉“”輸入解凍時間，最長時間為 95 分鐘。
- (3) 按“極速啓動”鍵，解凍開始。解凍火力為 **P 30**，且不能再修改火力。

6. 多段烹調

最多可輸入兩段烹調，若有解凍程式設置時可設定為第一段，隨後的第二段可設置為其它烹調程式。

例如：解凍 500g 食物，解凍完成後，執行 7 分鐘、80%微波烹調：



- (1) 按“按重/按時解凍”鍵一次，LED 顯示“dEF1”。
- (2) 旋轉“”選擇解凍重量 500g。
- (3) 按“火力”鍵一次，LED 閃爍顯示“P100”。
- (4) 繼續按“火力”鍵或旋轉“”選擇 80%火力，LED 顯示“P 80”。
- (5) 按“極速啓動”鍵確認當前火力。
- (6) 旋轉“”選擇微波烹調的時間 7 分鐘。
- (7) 按“極速啓動”鍵，烹調開始。



注意：“自動烹調”不能應用於多段烹調。

7. 預約功能

首先設定當前時鐘。然後輸入烹調程式，最多可設置兩段火力。解凍不能作為預約程式。



例如：在特定時間執行 7 分鐘、80%微波烹調：

- (1) 按“火力”鍵一次，LED 閃爍顯示“P100”。
 - (2) 繼續按“火力”鍵或旋轉“”選擇 80%火力，LED 顯示“P 80”。
 - (3) 按“極速啓動”鍵確認當前火力。
 - (4) 旋轉“”選擇微波烹調的時間 7 分鐘。
- 此時不要按“極速啓動”鍵，進行如下操作。

- (1) 按“時鐘/預約”鍵，小時位閃爍；
- (2) 旋轉“”，設置預約時間小時位，設置範圍 0-23；
- (3) 按“時鐘/預約”鍵，分鐘位閃爍；
- (4) 旋轉“”，設置預約時間分鐘位，設置範圍 0-59；
- (5) 按“極速啓動”鍵，完成預約設置。預約時間到，此時若爐門關閉，則微波爐鳴叫 2 聲自動開始烹調。

注意：設定“預約烹調”程式前，必須先設定時鐘，否則無法設置預約烹調。

8. 自動烹調

- (1) 在待機狀態下直接右旋“”，LED 顯示“A-1、A-2 至 A-8”共 8 款自動烹調選擇。
- (2) 按“極速啓動”鍵確認所選菜單。
- (3) 旋轉“”選擇重量。
- (4) 按“極速啓動”鍵，烹調開始。

種類	份量	顯示	火力
A-1 自動翻熱	200克	200	100%微波
	400克	400	
	600克	600	
A-2 新鮮蔬菜 (加水)	200克	200	100%微波
	300克	300	
	400克	400	
A-3 魚塊	250克	250	80%微波
	350克	350	
	450克	450	
A-4 肉類	250克	250	100%微波
	350克	350	
	450克	450	
A-5 義大利麵條	50克(加冷水 450 毫升)	50	80%微波
	100克(加冷水 800毫升)	100	
A-6 薯仔	200克	200	100%微波
	400克	400	
	600克	600	
A-7 薄餅	200克	200	100%微波
	400克	400	
A-8 湯	200 毫升	200	80%微波
	400 毫升	400	

9. 查詢功能

- (1) 在微波烹調時，按“火力”鍵可查詢火力，LED 常亮顯示火力 3 秒鐘。
- (2) 預約過程中，按“時鐘/預約”鍵查詢預約時間，LED 閃爍顯示預約時間 3 秒鐘。
- (3) 在烹調狀態下，按“時鐘/預約”鍵可查詢時鐘，即常亮顯示時鐘 3 秒鐘。

10. 童鎖功能

上電加鎖：爐門關閉，通電後直接進入童鎖狀態，LED 顯示“【:::】”。

解鎖：打開爐門或按住“停止”鍵 3 秒，蜂鳴器一聲長“嘀”即可解鎖。

自動加鎖：在待機狀態，若連續 1 分鐘無操作，蜂鳴器一聲長“嘀”，即表示進入童鎖狀態，LED 顯示“【:::】”；如果設置了時鐘則顯示時鐘。

解鎖：打開爐門或按住“停止”鍵 3 秒，蜂鳴器一聲長“嘀”即可解鎖。

加鎖：在待機狀態，按住“停止”鍵 3 秒，一聲長“嘀”即表示進入童鎖狀態，LED 顯示“【:::】”；如果設置了時鐘則顯示時鐘。

解鎖：在鎖定狀態，按住“停止”鍵 3 秒，一聲長“嘀”即可解鎖，LED 返回正常狀態下的顯示。

11. 烹調結束提示功能

- (1) 旋鈕開始旋轉時蜂鳴器鳴叫一聲；
- (2) 在烹調過程中打開爐門，必須再次按“極速啓動”鍵才可繼續烹調。
- (3) 一旦設定好烹調狀態，而在 1 分鐘內沒按“極速啓動”鍵，則顯示器恢復到時鐘顯示，所設定內容無效。
- (4) 有效按鍵蜂鳴器鳴叫一聲，無效按鍵無反應。
- (5) 烹調結束時蜂鳴器鳴叫五聲，提示用戶烹調完畢。

維修保養

故障診斷與維修

下列情況均屬正常	
微波爐干擾電視信號接收	微波爐工作時，收音機和電視的信號接收可能會受到干擾。同樣會對小家電如混合器、真空吸塵器和電風扇造成干擾。均屬正常現象。
微波爐燈光暗弱	低火力烹調時，微波爐燈管可能會變暗弱，屬正常現象。
蒸汽積聚爐門，有熱風從排氣口排出	烹調時，食物中會冒出蒸汽。大多數會從排氣口排出，但一些可能會聚集在較冷的地方，比如爐門。均屬正常現象。
爐內沒有食物時微波爐意外開始操作	禁止爐內無任何食物時操作該微波爐。此操作非常危險，很可能會損壞微波爐。

故障	可能原因	解決方法
微波爐無法啓動	(1) 電源綫沒有插緊	拔下插頭，待 10 秒鐘後重插
	(2) 保險絲燒斷或斷路器工作	更換保險絲或重新設置斷路器(由本公司專業人員負責維修)
	(3) 電源插座有問題	用其他電器測試插座是否有問題
微波爐不加熱	(4) 爐門未關好	關好爐門
微波爐運行時玻璃轉盤會發出響聲	(5) 滾筒支托和微波爐底變髒	參考“微波爐的維修保養”對不潔的部件進行清洗



產品或產品隨附文件上的此標志表示本產品不可視為家庭廢棄物，相反需將其交至相應的回收點對電氣和電子設備進行回收。

如日後需要棄置，請遵循本地的廢物棄置條例。

有關產品處理，恢復使用和回收的詳細數據，請聯繫本地政府機構、家庭廢棄物處理服務機構或購買本產品的商店。

棄置前請切斷電源綫，使本產品不能連接電源。

Microwave Oven
INSTRUCTION MANUAL
MODEL : MWH 303

Read these instructions carefully before using your microwave oven, and keep it carefully.

SAVE THESE INSTRUCTIONS CAREFULLY

PRECAUTIONS TO AVOID POSSIBLE EXPOSURE TO EXCESSIVE MICROWAVE ENERGY

- (a) Do not attempt to operate this oven with the door open since this can result in harmful exposure to microwave energy. It is important not to break or tamper with the safety interlocks.
- (b) Do not place any object between the oven front face and the door or allow soil or cleaner residue to accumulate on sealing surfaces.
- (c) **WARNING:** If the door or door seals are damaged, the oven must not be operated until it has been repaired by a competent person.

ADDENDUM

If the apparatus is not maintained in a good state of cleanliness, its surface could be degraded and affect the lifespan of the apparatus and lead to a dangerous situation.

Specifications

Model:	MWH 303
Rated Voltage:	230V~50Hz
Rated Input Power(Microwave):	1270W
Rated Output Power(Microwave):	800W
Oven Capacity:	20L

IMPORTANT SAFETY INSTRUCTIONS

WARNING

To reduce the risk of fire, electric shock, injury to persons or exposure to excessive microwave oven energy when using your appliance, follow basic precautions, including the following:

1. Warning: Liquids and other foods must not be heated in sealed containers since they are liable to explode.
 - a) Avoid to use narrow bottle.
 - b) Stir the liquid before cooking.
Put the spoon in the container when cooking.
 - c) Liquid shall be standed for a period time and stirred after cooking.
2. Warning: It is hazardous for anyone other than a competent person to carry out any service or repair operation that involves the removal of a cover which gives protection against exposure to microwave energy.
3. Warning: Only allow children to use the oven without supervision when adequate instructions have been given so that the child is able to use the oven in a safe way and understand the hazards of improper use.
4. Warning: When the appliance is operated in the combination mode, children should only use the oven under adult supervision due to the temperatures generated. (only for grill series)
5. Only use utensils suitable for use in microwave ovens.
6. The oven should be cleaned regularly and any food deposits should be removed.
7. Read and follow the specific: "PRECAUTIONS TO AVOID POSSIBLE EXPOSURE TO EXCESSIVE MICROWAVE ENERGY".
8. When heating food in plastic or paper containers, keep an eye on the oven due to the possibility of ignition.
9. If smoke is observed, switch off or unplug the appliance and keep the door closed in order to stifle any flames.
10. Do not overcook food.
11. Do not use the oven cavity for storage purposes. Do not store items, such as bread, cookies, etc. inside the oven.
12. Remove wire twist-ties and metal handles from paper or plastic containers/bags before placing them in the oven.
13. Install or locate this oven only in accordance with the installation instructions provided.
14. Eggs in the shell and whole hard-boiled eggs should not be heated in microwave ovens since they may explode, even after microwave heating has ended.
15. Use this appliance only for its intended uses as described in manual. Do not use corrosive chemicals or vapors in this appliance. This oven is especially designed to heat. It is not designed for industrial or laboratory use.
16. If the supply cord is damaged, it must be replaced by the manufacturer, its service agent or similarly qualified persons in order to avoid a hazard.
17. Do not store or use this appliance outdoors.
18. Do not use this oven near water, in a wet basement or near a swimming pool.
19. The temperature of accessible surfaces may be high when the appliance is operating. Keep cord away from heated surface, and do not cover any vents on the oven.
20. Do not let cord hang over edge of table or counter.
21. Failure to maintain the oven in a clean condition could lead to deterioration of the surface that could adversely affect the life of the appliance and possibly result in a hazardous situation.
22. The contents of feeding bottles and baby food jars shall be stirred or shaken and the temperature checked before consumption, in order to avoid burns.
23. Microwave heating of beverages can result in delayed eruptive boiling, therefore care must be taken when handling the container.

- 24. The appliance is not intended for use by persons (including children) with reduced physical, sensory or mental capabilities, or lack of experience and knowledge, unless they have been given supervision or instruction concerning use of the appliance by a person responsible for their safety.
- 25. Children should be supervised to ensure that they do not play with the appliance.
- 26. The microwave oven shall not be placed in a cabinet unless it has been tested in a cabinet.
- 27. Appliances are not intended to be operated by means of an external timer or separate remote-control system.
- 28. The door or the outer surface may get hot when the appliance is operating.
- 29. The rear surface of appliance shall be placed against a wall.

To Reduce the Risk of Injury to Persons

Grounding Installation

DANGER

Electric Shock Hazard

Touching some of the internal components can cause serious personal injury or death. Do not disassemble this appliance.

This appliance must be grounded. In the event of an electrical short circuit, grounding reduces the risk of electric shock by providing an escape wire for the electric current. This appliance is equipped with a cord having a grounding wire with a grounding plug. The plug must be plugged into an outlet that is properly installed and grounded.

WARNING

Electric Shock Hazard

Improper use of the grounding can result in electric shock. Do not plug into an outlet until appliance is properly installed and grounded.

Consult a qualified electrician or serviceman if the grounding instructions are not completely understood or if doubt exists as to whether the appliance is properly grounded.

CLEANING

Be sure to unplug the appliance from the power supply.

1. Clean the inside of the oven after using with a slightly damp cloth.
2. Clean the accessories in the usual way in soapy water.
3. The door frame and seal and neighbouring parts must be cleaned carefully with a damp cloth when they are dirty.

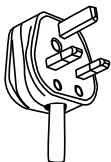

CAUTION

Personal Injury Hazard

It is hazardous for anyone other than a competent person to carry out any service or repair operation that involves the removal of a cover which gives protection against exposure to microwave energy.

UTENSILS

See the instructions on "Materials you can use in microwave oven or to be avoided in microwave oven."

There may be certain non-metallic utensils that are not safe to use for microwaving. If in doubt, you can test the utensil in question following the procedure below.

Utensil Test:

1. Fill a microwave-safe container with 1 cup of cold water (250ml) along with the utensil in question.
2. Cook on maximum power for 1 minute.
3. Carefully feel the utensil. If the empty utensil is warm, do not use it for microwave cooking.
4. Do not exceed 1 minute cooking time.

Materials you can use in microwave oven

Utensils	Remarks
Aluminum foil	Shielding only. Smooth pieces with smaller size than half of glass turntable can be used to cover thin parts of meat or poultry to prevent overcooking. Arcing can occur if foil is too close to oven walls. The foil should be at least 1 inch (2.5cm) away from
Browning dish	Follow manufacturer's instructions. The bottom of browning dish must be at least 3/16 inch (5mm) above the turntable. Incorrect usage may cause the turntable to break.
Dinnerware	Microwave-safe only. Follow manufacturer's instructions. Do not use cracked or chipped dishes.
Glass jars	Always remove lid. Use only to heat food until just warm. Most glass jars are not heat resistant and may break.
Glassware	Heat-resistant oven glassware only. Make sure there is no metallic trim. Do not use cracked or chipped dishes.
Oven cooking bags	Follow manufacturer's instructions. Do not close with metal tie. Make slits to allow steam to escape.
Paper plates and cups	Use for short-term cooking/warming only. Do not leave oven unattended while cooking.
Paper towels	Use to cover food for reheating and absorbing fat. Use with supervision for a short-term cooking only.
Parchment paper	Use as a cover to prevent splattering or a wrap for steaming.
Plastic	Microwave-safe only. Follow the manufacturer's instructions. Should be labeled "Microwave Safe". Some plastic containers soften, as the food inside gets hot. "Boiling bags" and tightly closed plastic bags should be slit, pierced or vented as directed by package.
Plastic wrap	Microwave-safe only. Use to cover food during cooking to retain moisture. Do not allow plastic wrap to touch food.
Thermometers	Microwave-safe only (meat and candy thermometers).
Wax paper	Use as a cover to prevent splattering and retain moisture.

Materials to be avoided in microwave oven

Utensils	Remarks
Aluminum tray	May cause arcing. Transfer food into microwave-safe dish.
Food carton with metal handle	May cause arcing. Transfer food into microwave-safe dish.
Metal or metal-trimmed utensils	Metal shields the food from microwave energy. Metal trim may cause arcing.
Metal twist ties	May cause arcing and could cause a fire in the oven.
Paper bags	May cause a fire in the oven.
Plastic foam	Plastic foam may melt or contaminate the liquid inside when exposed to high temperature.
Wood	Wood will dry out when used in the microwave oven and may split or crack.

SETTING UP YOUR OVEN

Names of Oven Parts and Accessories

Remove the oven and all materials from the carton and oven cavity.

Your oven comes with the following accessories:

Glass tray	1
Turntable ring assembly	1
Instruction Manual	1

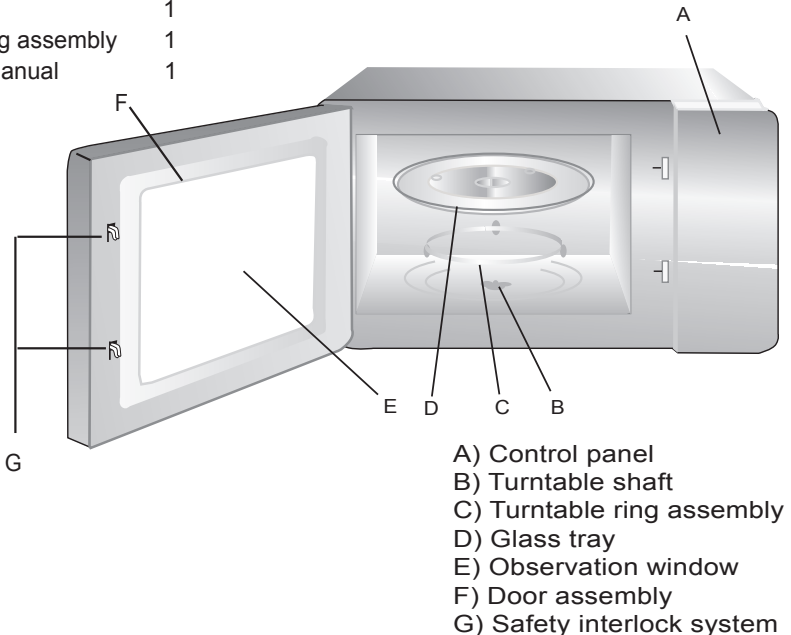

Turntable Installation

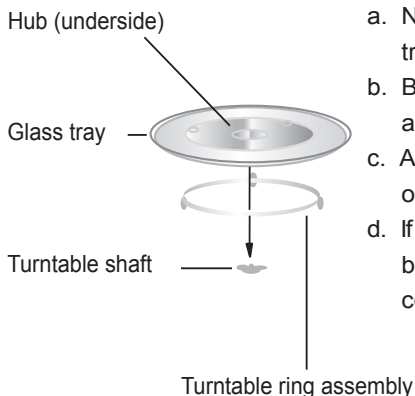

- Never place the glass tray upside down. The glass tray should never be restricted.
- Both glass tray and turntable ring assembly must always be used during cooking.
- All food and containers of food are always placed on the glass tray for cooking.
- If glass tray or turntable ring assembly cracks or breaks, contact your nearest authorized service center.

Countertop Installation

Remove all packing material and accessories. Examine the oven for any damage such as dents or broken door. Do not install if oven is damaged.

Cabinet: Remove any protective film found on the microwave oven cabinet surface. Do not remove the light brown Mica cover that is attached to the oven cavity to protect the magnetron.

Installation

- Select a level surface that provide enough open space for the intake and/or outlet vents.

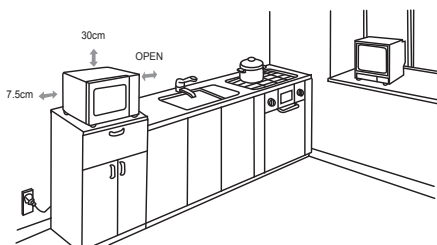

A minimum clearance of 7.5cm is required between the oven and any adjacent walls. One side must be open.

- Leave a minimum clearance of 30cm above the oven.
- Do not remove the legs from the bottom of the oven.

- Blocking the intake and/or outlet openings can damage the oven.
- Place the oven as far away from radios and TV as possible. Operation of microwave oven may cause interference to your radio or TV reception.
- Plug your oven into a standard household outlet. Be sure the voltage and the frequency is the same as the voltage and the frequency on the rating label.

WARNING: Do not install oven over a range cooktop or other heat-producing appliance. If installed near or over a heat source, the oven could be damaged and the warranty would be void.

OPERATION

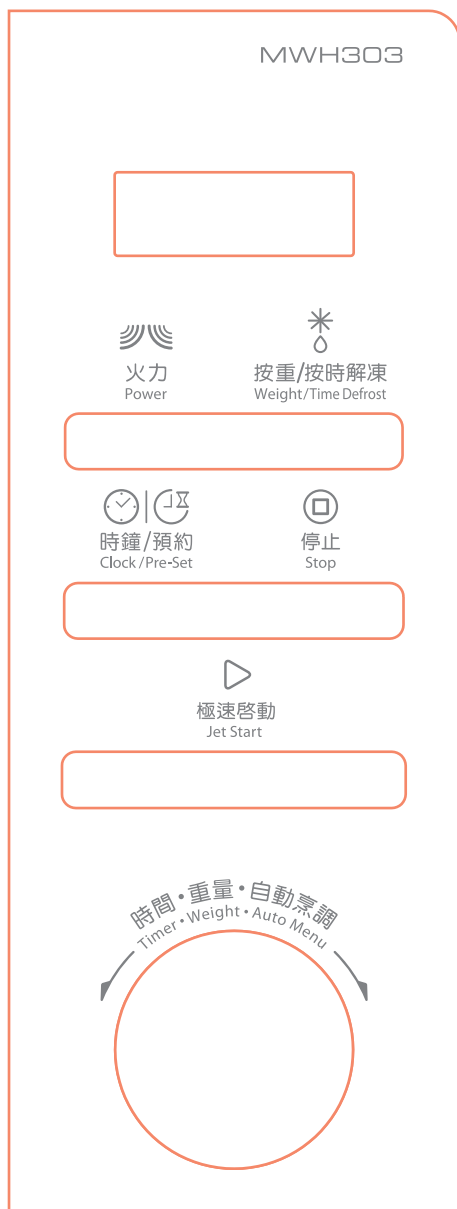

Control Panel and Features



OPERATION INSTRUCTION

1.Clock Setting



When the microwave oven is first turned on, the oven will display "0:00", the buzzer will ring once.

- 1) Press "**CLOCK/PRE-SET**" button and the hour figures will flash.
- 2) Turn the "  " dial to adjust the hour figures.
the input time should be within 0 - 23.
- 3) Press "**CLOCK/PRE-SET**" button again and the minute figures will flash.
- 4) Turn the "  " dial to adjust the minute figures, the input time should be within 0 - 59.
- 5) Press "**CLOCK/PRE-SET**" to finish the clock setting procedure. The ":" will then flash.

Note:

- 1) The clock will not count if it is not set when powered.
- 2) During the process of clock setting, if you press "**STOP**", the oven will go back to the previous status.

2.Microwave Cooking

- 1) Press the "**POWER**" button once, and "P100" will display and flash.
- 2) Turn the "  " to select the microwave power. "P100", "P80", "P50", "P30", "P10" will display in order.
or
Press the "**POWER**" button to scroll through the power levels.
- 3) Press "**JET START**" to confirm.
- 4) Turn the "  " dial to adjust the cooking time.
(The time setting should be between 0:05- 95:00.)
- 5) Press "**JET START**" to start the cooking process.

Press power button	Cooking power
P100	100%
P80	80%
P50	50%
P30	30%
P10	10%

To stop the cooking process at anytime press the **"STOP"** button.

3.Speedy Cooking

Press the **"JET START"** button to microwave cook at 100% power level for 30 seconds.

The microwave will start cooking immediately.

Each press on the same key will increase the cooking time by 30 seconds.

The maximum cooking time is 95 minutes.

Note: this function does not work for weight defrost and auto menu cooking.

or

Turn the "  " dial left to adjust the desired cooking time, then press **"JET START"**. The oven will start cooking for the selected length of time at 100% power.

4.Defrosting by Weight

- 1) Press **"WEIGHT/TIME DEFROST "** button once, the oven will display "dEF1".
- 2) Turn the "  " dial to select the weight of the food in grams. The weight should be set between 100-2000g.
- 3) Press **"JET START"** button to start defrosting.



5.Defrosting by Time

- 1) Press **" WEIGHT/TIME DEFROST "** button twice, the oven will display "dEF2".
- 2) Turn the "  " dial to select the defrosting time, the maximum time is 95 minutes.
- 3) Press **"JET START"** button to start defrosting.
The defrosting power is 30%, and cannot be changed.

6. Multi Stage Cooking

To set a maximum of two different stages. For instance, to defrost an item and the follow it with the cooking cycle.

Example: if you want to defrost 500g of food, then cook it at 80% microwave power for 7 minutes. The steps are as follows:

- 1) Press "**WEIGHT/TIME DEFROST**" button once, the screen will display "DEF1".
- 2) Turn the " " dial to adjust the defrost weight to 500g;
- 3) Press the "**POWER**" button once;
- 4) Turn the " " dial to choose 80% microwave power till "P80" displays;
- 5) Press "**JET START**" to confirm;
- 6) Turn the " " dial to adjust the cooking time to 7 minutes;
- 7) Press the "**JET START**" button to start the cooking process.





Note: Auto menu cannot be set as one of the multi-stage cooking functions.

7. Pre-set time to start functions

Set the clock first. (Consult the instructions for setting the clock)

Input the cooking program. It's possible to input a maximum of 2 cooking stages. Do not use the defrost function in the pre-set function.

Example: if you want to cook with 80% microwave power for 7 minutes, to start at a given time.

- 1) Press the "**POWER**" button once;
- 2) Turn the " " dial to choose 80% microwave power till "P80" is displayed;
- 3) Press "**JET START**" button to confirm;
- 4) Turn the " " dial to adjust the cooking time to 7 minutes;
- 5) After the above steps, **DO NOT** press "**JET START**" button, but do as follows :
- 6) Press the "**CLOCK/PRE-SET**" button, the current time displays and the hour figures flash.
- 7) Turn " " dial to adjust the hours, the input time should be within 0 -23. Press "**CLOCK/PRE-SET**" button and the minute figures will flash. Turn the " " dial to adjust the minutes, the input time should be within 0 - 59. This sets the start time.



8) Press "JET START" to finish setting.

The ":" will illuminate, the buzzer will ring twice when the time to start arrives, and then cooking will start automatically.

Note: The clock must be set first. Otherwise, the pre-set function will not work.

8.Auto Menu

The microwave can automatically calculate the cooking time based on the type of food and weight.

- 1) Turn the "  " dial clockwise, "A-1" will display on the screen.
Continue to rotate the dial to access the other auto selections, up to A-8.
- 2) Press the "JET START" button to select the chosen auto, A-1 - A-8.
- 3) Turn the "  " dial to choose the food weight, these are pre-set and listed below.
- 4) Press "JET START" button to start cooking.

Please see the table below for the various settings.

Display	Auto Menu	Weight	Display	Power
A-1	Reheat	200g	200	100%
		400g	400	
		600g	600	
A-2	Vegetable Add water.	200g	200	100%
		300g	300	
		400g	400	
A-3	Fish	250g	250	80%
		350g	350	
		450g	450	
A-4	Meat	250g	250	100%
		350g	350	
		450g	450	
A-5	Pasta	50g(add 450ml water)	50	80%
		100g(add 800ml water)	100	
A-6	Potato	200g	200	100%
		400g	400	
		600g	600	
A-7	Pizza	200g	200	100%
		400g	400	
A-8	Soup	200ml	200	80%
		400ml	400	

9. Checking Functions

- 1) During the cooking cycle, press the "**POWER**" button and the current power will be displayed for 3 seconds.
- 2) In pre-set state, press the "**CLOCK/PRE-SET**" button to check the time when the cooking will start. The pre-set time will flash for 3 seconds, then the oven will turn back to the clock display.
- 3) During the cooking cycle, press the "**CLOCK/PRE-SET**" button to check the current time. It will be displayed for 3 seconds.

10. Child lock

Lock on: The microwave oven will be locked on directly when powered on firstly with the door closed. LED will display "E : : J".

Lock off: Open the door or press "**STOP**" button for 3 seconds, there will be a long "beep".

Lock on: In standby state, when nothing is operating in 1 minute, there will be a long "beep" as the lock activates. LED will display "E : : J". The current will display if the clock has been set.

Lock off: Open the door or press "**STOP**" button for 3 seconds, there will be a long "beep".

Lock on: In standby, when nothing is operating, press "**STOP**" button for 3 seconds, there will be a long "beep" as the lock activates. LED display "E : : J".

Lock off: In locked state, press "**STOP**" button for 3 seconds, there will be a long "beep".

The current time will continue to display.

When the child lock is on, no functions can be activated.

11. General information

- 1) The buzzer will sound once when turning the knob at the beginning;
- 2) The "**JET START**" button must be pressed again to continue cooking if the door is opened during a cooking cycle.
- 3) Once the cooking programme has been set, if the "**JET START**" button is not pressed in 1 minute. The current time will display and the setting will be cancelled.
- 4) The buttons will beep if they are pressed correctly, if not pressed correctly they will not beep.
- 5) The buzzer will sound five times to remind you when cooking is finished.

Trouble shooting

Normal	
Microwave oven interfering TV reception	Radio and TV reception may be interfered when microwave oven operating. It is similar to the interference of small electrical appliances, like mixer, vacuum cleaner, and electric fan. It is normal.
Dim oven light	In low power microwave cooking, oven light may become dim. It is normal.
Steam accumulating on door, hot air out of vents	In cooking, steam may come out of food. Most will get out from vents. But some may accumulate on cool place like oven door. It is normal.
Oven started accidentally with no food in.	It is forbidden to run the unit without any food inside. It is very dangerous.

Trouble	Possible Cause	Remedy
Oven can not be started.	(1) Power cord not plugged in tightly.	Unplug. Then plug again after 10 seconds.
	(2) Fuse blowing or circuit breaker works.	Replace fuse or reset circuit breaker (repaired by professional personnel of our company)
	(3) Trouble with outlet.	Test outlet with other electrical appliances.
Oven does not heat.	(4) Door not closed well.	Close door well.
Glass turntable makes noise when microwave oven operates	(5) Dirty roller rest and oven bottom.	Refer to "Maintenance of Microwave" to clean dirty parts.



According to Waste of Electrical and Electronic Equipment (WEEE) directive, WEEE should be separately collected and treated. If at any time in future you need to dispose of this product please do NOT dispose of this product with household waste. Please send this product to WEEE collecting points where available.