

Register your product online

網上登記新產品保養

Save the planet and register your product warranty online!
Enjoy extra 1-month free warranty upon online registration.

「惠」環保出力，減少用紙！於網上登記產品更可獲額外多一個月保養。



<https://rebrand.ly/WPwarranty>

Whirlpool® Registered trademark/TM Trademark of Whirlpool group of companies

All rights reserved - <http://www.whirlpool.com.hk>

註冊商標/惠而浦集團的TM商標

版權所有 翻印必究 - <http://www.whirlpool.com.hk>



Whirlpool

裝訂線-勿印刷

Whirlpool

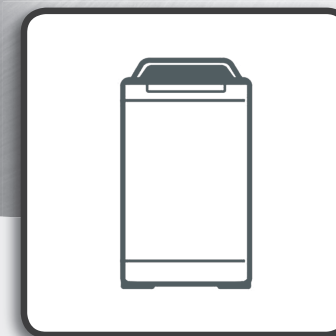

Health & Safety, Use & Care, Installation Guide and Online Warranty Registration Information

產品安全指引、使用說明、安裝指南及
網上登記保養資料

Model 產品型號：VEMC65810



www.whirlpool.com.hk



CONTENTS

IMPORTANT SAFEGUARDS	2-4
CARE AND MAINTENANCE	4
ACCESSORIES	5
NAME OF PARTS	5
INSTALLATION INSTRUCTIONS	6-10
NAMES AND FUNCTIONS OF CONTROL PANEL	11-12
NORMAL USAGE	13
HOW TO USE PROGRAM AND PROCESS	14-15
THE PREPARATION OF LAUNDRY BEFORE WASHING	15
OTHER FUNCTIONS	
BLANKET	15
WATER LEVEL SETTING	16
DOUBLE-LEVEL POWER WASH	16
MEMORY FUNCTION	16
CHILD LOCK FUNCTION	16
CANCEL THE END BUZZER	16
POWER DISSOLVE	16
TROUBLE SHOOTING GUIDE	17
NOT FAILURE INDICATION	18
SPECIFICATIONS	37







IMPORTANT SAFEGUARDS

Please read this instructions manual carefully before using your machine.

- The precautions stated here are classified as "Warning" and "Attention" according to the damage and the emergency caused by misoperation, and are described respectively in line with the marks below.

 Warning	Misoperation may cause death.
 Attention	Misoperation may cause body injury or damage the machine.

		
This mark indicates the content of warning or attention.	This mark indicates the prohibited action.	This mark indicates the compulsory action to be carried out.

 Warning	
<ul style="list-style-type: none">  Dismantling, repair or alterations should only be carried out by professional technician as otherwise you may be subject to electric shock, may cause fire or get injured. 	<ul style="list-style-type: none"> This washing machine is equipped with a 3 pin plug which includes an earthing wire. This appliance must be earthed. 
<ul style="list-style-type: none"> Electricity supply must be unplugged with dry hands. Otherwise, this may cause electric shock. 	<ul style="list-style-type: none"> Do not put water in direct contact with the unit during maintenance and repair. This may cause short circuit or electric shock. 
<ul style="list-style-type: none"> Damaged or loosen wire or plug should not be used. Otherwise electric shock, short circuit or fire may take place. Do not damage wire. Do not damage or alter the wire forcibly bend, pull twist or handle the wire. Beside, please do not put weight on or trap the wire. Damage of wire may cause electric shock or fire. 	<ul style="list-style-type: none"> Do not put gasoline, benzene, alcohol, thinner of fabrics with these stains into or near to the washing machine. To prevent fire or explosion which may cause injuries. 

IMPORTANT SAFEGUARDS

⚠ Warning

- Keep child away from the wash/spin tub and do not place box or shelves next to the washing machine.

Children may fall in to the tub resulting in injuries.

This appliance is not intended for use by persons (including children) with reduced physical, sensory or mental capabilities, or lack of experience and knowledge, unless they have been given supervision or instruction concerning use of the appliance by a person responsible for their safety.



Prohibited

- Do not put your hand into the wash/spin tub until it has stopped completely.

Even when the spinning of the tub is slow, there is still a danger of being caught in the motion, resulting injuries. Particular attention should be paid when children are around.



- Do not put your hands into the wash/spin tub during the washing and rinsing process.

Even when the spinning is slow, hands may be trapped by clothes. If necessary, please press pause button, and put your hands into the tub after it has stopped completely.



Prohibited



- Please use the single socket with special voltage and current matched with plug marked specification.

The share of the same socket with other electric appliances may cause fire due to excessive loading.



Clear

- Thoroughly wipe the power plug when dirt is adhering the prong or around the base of the prong.

Failure to do so may cause a fire.

- Washing machine should not be installed in humid place or in places exposed to wind and rain.

Otherwise, electricity leakage causing electric shock or fire may occur.



Prohibited

- This washing machine is strictly prohibited to get close to the locations with candle, mosquito-repellent incense, dog-end or other kinds of open flame.

To avoid injuries caused by the lock damage.



Prohibited

⚠ Attention

- Do not pull the wire from the socket when unplugging the unit.

To avoid electric shock or fire cause by short circuit may result.



Prohibited



- Electricity supply must be unplugged with dry hands during maintenance and repair.

Otherwise, electric leakage causing injuries may occur.

If the power cord or supply cord is damaged, the manufacturer or its service agent or similarly qualified person must replace it in order to avoid a hazard.



- Please unplug the unit when not using the unit for a long period of time.

Electric shock or leakage may occur due to deformation of plastic parts of the unit.

- Do not connect to the hot water supply, if use warm water, water of above 50°C should not be used for washing.

Electric shock or leakage may occur due to deformation of plastic parts of the unit.



Prohibited

IMPORTANT SAFEGUARDS

⚠ Attention

- Do not wash, rinse and spin the water proof fabric or cloth.

Sleeping bag, raincoat, cover of skiing, utilities, bicycles, cars and motors. Otherwise may lead to injury by abnormal vibration during spinning or damage the washing machine, wall, floor and clothes.

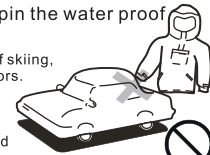

Prohibited

- Do not stand on or put weight on the top of the unit.

Otherwise, deformation and damage may cause injuries.



Prohibited

- Keep hands and feet away from the bottom of the washing when it is in motion.

Ports in motion beneath in the unit may cause injuries.



Prohibited



Water leakage

Water supply hose should be tightly screwed to the unit.

Failure to do so may result in water leakage. Used for a long period of time, the unit may result in water leakage caused by loosen union nut. So please check it in time and screw tightly again.



Water leakage

- Check water supply hose connection by turning on the water before washing. To prevent damages caused by possible water leakage due to loosen screw or not tighten.

The new hose-sets supplied with the appliance are to be used and that old hose-sets should not be reused.

Do not block the ventilation openings at the bottom of washer by carpeting when the washer is installed on a carpeted floor.

- Please turn off the water tap when not using the unit.

To prevent damages caused by water leakage.



CARE AND MAINTENANCE

Clean washing machine

Use soft clothing to wipe off the water or dirt on the surface of the washer.

- Do not spray water directly to the washer body.
- Detergent, propellant and other chemicals are not allowed to use to avoid the damages on the surface.



Clean the water inlet valve

(Suggest cleaning it every 6 months)

After long time use, the water inlet mesh bag may be blocked with crud, please load off the water inlet hose, take out the water inlet mesh bag from the water inlet valve, clean the mesh bag, then assemble the mesh bag in the valve and load the water inlet hose.



Water Inlet

Clean hose filter

(Suggest cleaning it every 6 months)

1. Turn the nut of water supply hose counter clockwise, take down water hose.
2. Clean the crud with a toothbrush.
3. Install the clean water hose

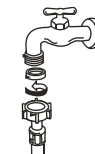

Clean lint filter





(Suggest cleaning it every time after use)

1. Take out the lint filter.
2. Pull out the scraps and wash the lint filter in the water.
3. Install the filter (aim the frame claw to the groove below).

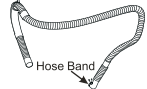

(Lint filter is easily destroyed parts).

ACCESSORIES

Instruction manual (1 book)	Drain Hose (1 piece)	Water Supply Hose (1 piece)	Bottom Cover (1 piece)	Screw (1 piece)
				

NAME OF PARTS

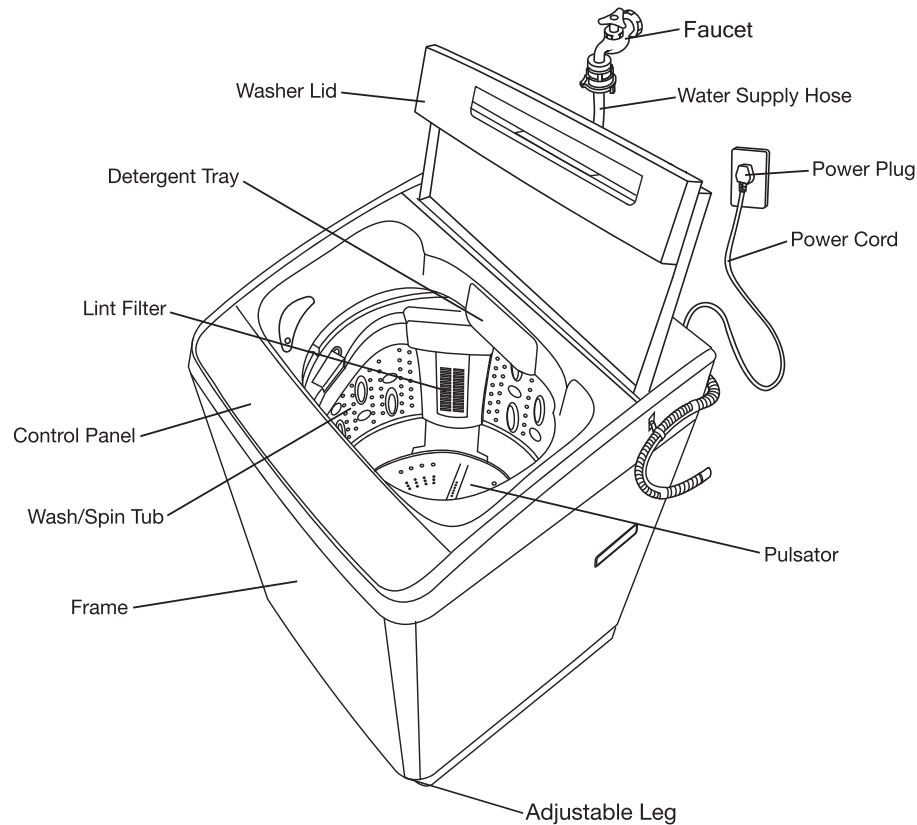

INSTALLATION INSTRUCTIONS

Installing the Bottom Cover

- Put out the bottom cover and parts bag of screws .
- Gently lay down the back side of washer on a soft mat or cushion.
(Be careful not to dent the frame.)
- Insert the attached bottom cover into the hooks of leg by straightly pushing until it reaches into the back hooks.
- Fasten the bottom cover with a screw.
- Gently set the washer upright.

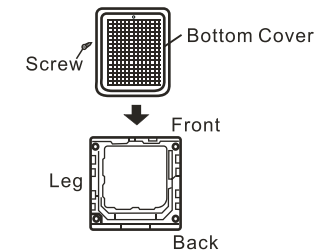

Location of Washer

- Choose a dry location out of sunlight for the washer.
- Install the washer on a stable and level surface.



- Adjust the adjustable leg of washer if necessary to make the washer level as shown in the diagram.

- The maximum permissible inclination of the supporting surface is 2°.

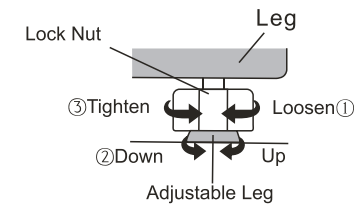

CAUTIONS:

- The washer must be installed so that its bottom opening will be not obstructed by the carpet etc.
- If the washer installed on the carpeted floor or elastic table may cause vibration issue.

INSTALLATION INSTRUCTIONS

Connecting the Water Supply Hose

1. Check that sealing washers are firmly seated.
2. Attach the curved end of the hose to the inlet valve of the washing machine, Tighten the coupling nuts securely by hand.
3. Attach straight end of the hose to the tap. Tighten the coupling nuts securely by hand.
4. Turn on the taps and check for leaks. Tighten the coupling nuts firmly if there is any leakage. If water pressure is strong, close the water tap completely then open it slightly.

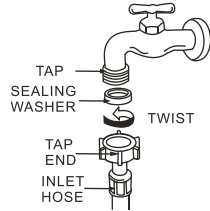

CAUTIONS:

- Do not use water which is hotter than 50°C.
- If the water supply hose does not match with your faucet, please consult your dealer.

Installing Water Supply Hose to the Washer

Turn the nut clockwise till the nut turned tight while holding the hose.

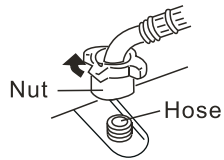

Turn the nut counterclockwise after turning the faucet off when you want to detach the water supply hose.

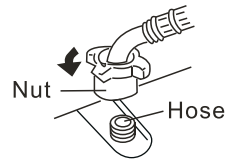

INSTALLATION INSTRUCTIONS

For high draining level installation

Installing the Drain Hose

1. Connect the water drainage hose with the water drainage joint on the back of the body. Fully insert it into the position to avoid leakage.
2. After the connection is completed, please use hose clipper to clamp the water drainage hose to avoid falling off.

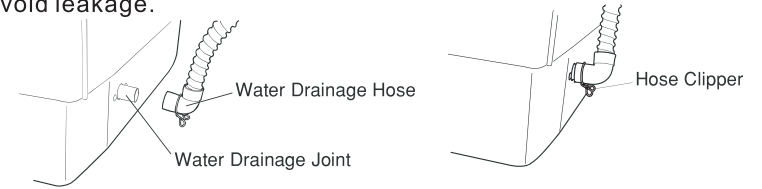

3. ① Insert the fixing holder of water drainage hose into mounting hole.
② As shown below, rotate the fixed leg for 90 degree into the hole.
4. Pull the water drainage hose straight, concave to fix into the fixing holder of water drainage hose.

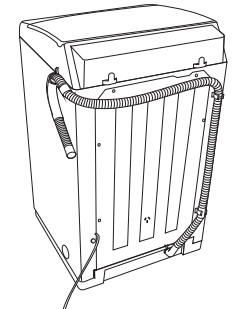
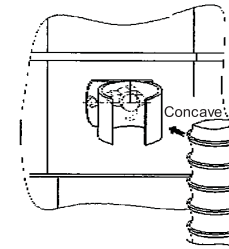
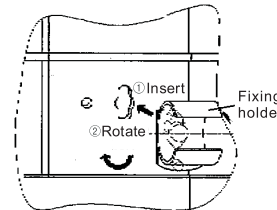

INSTALLATION INSTRUCTIONS

CAUTION:

- Do not release the water drainage hose lest the water is splashed.
- Do not use extended water drainage hose.
- Do not immerse the tail of the U-shaped hose in the water.
- Be sure not to install the water drainage hose at a position lower than water drainage joint, otherwise, it could lead to difficulties in water drainage .

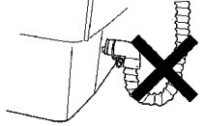

- Please make sure to keep the height of drain hose below 1000 mm during washing, otherwise, the washer mightn't work properly.

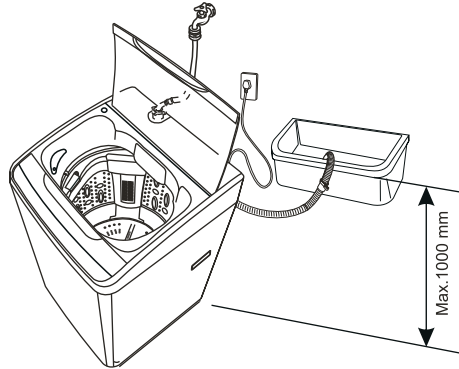

INSTALLATION INSTRUCTIONS

For low draining level installation

Installing the Drain Hose

1. Pinching the two bands of the clamp on the drain hose, connect it to the pump (rear of cabinet) and fix the hose band.
2. Pull the drain hose upward and fix it to the hose clip at the back cover of cabinet.
3. Hang the drain hose to the hole on right side of top frame when the washer is not working. And put the drain hose to drain spout when washer start working.

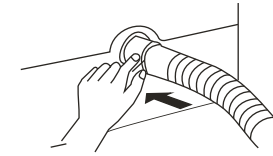
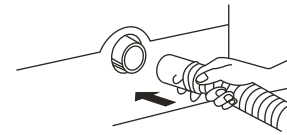

NAMES AND FUNCTIONS OF CONTROL PANEL

NAMES AND FUNCTIONS OF CONTROL PANEL

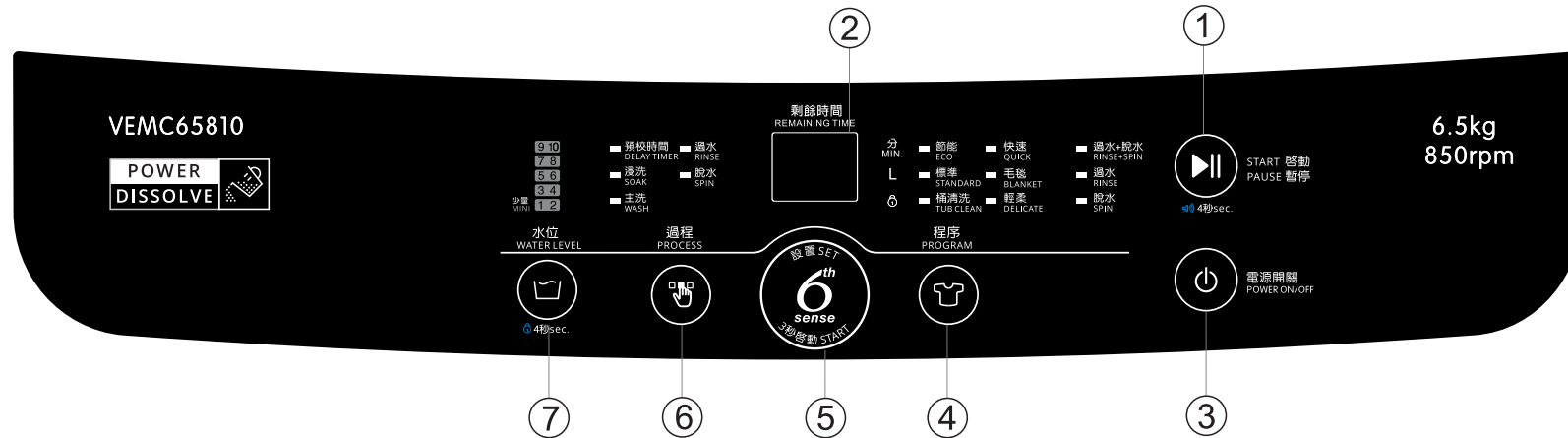

① START/PAUSE Button

- This button can be used to start the washer.
- This button can also be used to temporarily stop the washer. To restart the washer, press the START / PAUSE button again.

NOTE:

- This is not a cancel button.
- If you want to cancel the End Buzzer, press the START/PAUSE button and hold it down for about 4 seconds until beeping stops.

② DIGITAL INDICATOR

- This indicator shows remaining time during washing.
(e.g.) Remaining time is 20 minutes
- When setting PROCESS, the digital display indicates time or times.
(e.g.) Two times of Rinses

- This indicator shows when the washing is finished during presetting.
(e.g.) Finish washing 2 hours later
- When abnormal conditions occur, the indicator will indicate warning code.
(e.g.) Water does not flow

③ POWER ON/OFF Button

To turn the power on, press the POWER ON/OFF. When you want to turn off the power, press the POWER ON/OFF again. When the washing has finished, the power will be turned off in 5 seconds automatically.

NOTE:

- If you want to change the washing program, turn the POWER ON/OFF off and then, turn it on again.
- If you leave the washer turned on without starting the operation, the power will turn off in 10 minutes itself.

④ PROGRAM Button

- To choose the washing course, press the PROGRAM button. Press it and choose the course that you need, then the light on.

⑤ “6th sense” Button

- Once the power is ON, hold this button for 3 seconds to start STANDARD washing cycle.
- Once the power is ON, push “POWER ON/OFF” button, then “PROCESS” to any of the function with indicator flashing. Then use this button to set timing for PRESET, SOAK, WASH, RINSE and SPIN.

⑥ PROCESS Button

- The PROCESS and “6th sense” button can be used to select DELAY TIMER, SOAK, WASH time, number RINSE and SPIN time. For example, to set number of RINSE: Press the PROCESS button till RINSE light flashes. Then, press the “6th sense” button to choose the number of RINSE that you want.

⑦ WATER LEVEL Button

- You can choose the appropriate water level that matches the loading size.
- Different water levels for washing and rinsing option.
- You can set the CHILD LOCK function. Refer to other function on page 16.

NORMAL USAGE

- Preparation
 - Make sure to fit the drain hose.
 - Connect the water supply hose to the faucet and turn the faucet on. Make sure that the inlet connector screws are tighten. Otherwise it may cause water leakage.
 - Plug the power cord into a socket.
 - Put the clothes inside.
- Press POWER ON/OFF button
- Press START / PAUSE button
 - Sensor senses the clothes weight automatically. (For STANDARD / ECO), sets the proper water power, water level, wash/spin time and number of rinse automatically.
 - It is not available for the 2 lowest water levels. Need to manually set it, if needed.
- Put the detergent into the detergent case or the tub.
- Close the washer lid

VEMC65810										
Water Level	1	2	3	4	5	6	7	8	9	10
Water Volume (Approx. L)	1 5	1 8	2 1	2 4	2 8	3 2	3 8	4 2	4 5	5 0

CAUTIONS:

- You can use softener, pour the softener slowly to softener dispenser before washing.
- Too much detergent causes poor rinsing and too little detergent causes poor washing result.

HOW TO USE PROGRAM AND PROCESS

- Preparation: Fit the drain hose, turn the water supply faucet on, plug the power plug into a socket, put clothes inside.
- Press POWER ON/OFF button.
- Press PROGRAM button to choose the program you need according to the types of clothes. Please refer to below chart for program choosing.

HOW TO USE PROGRAM AND PROCESS

PROGRAM GUIDE		
PROGRAM	Water Power	Types of Clothes
STANDARD	Standard	Soiled and daily used clothes
ECO	Standard	Energy saving program (Use for energy efficiency test setting)
TUB CLEAN	Strong	Wash the tub to keep the freshness
BLANKET	Standard	Blanket or Bulky laundry / items
DELICATE	Soft	Women underwear, articles with embroider
QUICK	Standard	Less dirty clothes
RINSE+SPIN	—	Clothing only need RINSE and SPIN
RINSE	—	Clothing only need RINSE
SPIN	—	Clothing only need SPIN

- Press PROCESS button to choose SOAK, WASH, SPIN time, and number of RINSE.
 - DELAY TIMER time indicating
 0 → 1 → 2 → ... → 5 → 6 → ... → 24 hours
 ↑ _____
 - SOAK time indicating
 0 → 5 → 10 → ... → 35 → 40 minutes (This function is not available for DELICATE / BLANKET program).
 ↑ _____
 - WASH time indicating
 0 → 1 → 2 → ... → 19 → 20 minutes
 ↑ _____
 - Number of RINSE indicating
 0 → 1 → 2 → 3 → 4
 ↑ _____
 - SPIN time indicating
 0 → 1 → 2 → ... → 8 → 9 minutes
 ↑ _____
 0 → 1 → 2 → 3 minutes (For DELICATE program).
 ↑ _____
 - Rinse+spin, Rinse, Spin Program Could Only Set Rinse/spin Parameter
- Press WATER LEVEL button to choose proper water level and then put detergent.
- Press START/PAUSE button.
- Close the washer lid
 - If you want to change PROGRAM or PROCESS during operation, please switch off, restart and choose the program you need again.

HOW TO USE PROGRAM AND PROCESS

THE DEFAULT OPERATION OF EACH PROGRAM

PROGRAM	Wash Time (minutes)	Number of Rinse	Spin Time (minutes)
STANDARD	5~12	Rinse 2 times	4~6
TUB CLEAN	20	Rinse 1 times	9
DELICATE	6	Rinse 2 times	2
BLANKET	12	Rinse 2 times	8
ECO*	10	Rinse 2 times	5
QUICK	5	Rinse 1 times	3
RINSE+SPIN	—	Rinse 1 times	5
RINSE	—	Rinse 1 times	—
SPIN	—	—	5

* Use for energy efficiency test setting (base on adjustable setting of water level, wash time, number of rinse, and spin time)

- Total operation time of each program may vary due to different water pressure.

THE PREPARATION OF LAUNDRY BEFORE WASHING

- Make sure that nothing remains in the pocket. (Pin, coin etc. that can possibly damage clothes or the washing machine, and the extra noise may cause damage to the washing machine).
- Turn the clothes inside out to get rid of scraps.
- Woolen items like women underwear, articles with embroidery, nylon etc, should be placed in a laundry net for extra protection.
- Close the fastener and tie loose laces.
- Brush off the dirty parts like dust, sand.
- Put light clothes down. Please pause the operation and push them into the water when they float up.
- Please separate the washing of white clothes from coloured clothes, coats from underwear.

OTHER FUNCTIONS

BLANKET

1. Press POWER ON/OFF button and set the drainage hose position.
2. Turn the faucet on and press PROGRAM button till BLANKET light on.
3. Dissolve the detergent with around 5L warm water (approx.30°C), pour it into the tub of the washing machine.
4. Fold up the blanket as the method shown in the diagram below and pour it into the washing tub.
5. Press START/PAUSE button.
6. Close the washer lid.

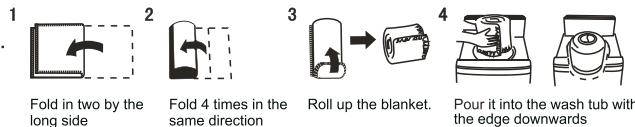

OTHER FUNCTIONS

WATER LEVEL SETTING

This button allows you to choose the appropriate water level during WASH/RINSE process.

Method:

Press PROCESS till WASH light flashes, press the WATER LEVEL button to choose the appropriate water level, press the “6th sense” button to set wash time. Then press the PROCESS button till RINSE light flashes, press the WATER LEVEL button to choose the appropriate water level, press the “6th sense” button to set number of RINSE. Then press the PROCESS button till SPIN light flashes, press the “6th sense” button to set SPIN time. Finally press the START/PAUSE button, the washer will operate according to the water level as set for washing and rinsing process.

DOUBLE-LEVEL POWER WASH

The washer will start washing when water to the level below 2 levels as set. By this, the washer starts working with more density of detergent.

- This function would not be effected when select level 1 or level 2 water, and DELICATE or BLANKET program.
 - When SOAK is selected, this function will not be effected after soaking.
- Note: This is a default function, setting is not available.

MEMORY FUNCTION

When STANDARD, ECO program is selected, 15 seconds after starting, the machine will remember this program and will start with the same while working the next time.

- This function is not available for DELICATE/BLANKET/TUB CLEAN/QUICK/RINSE +SPIN/RINSE/SPIN program.
- DELAY TIMER and WATER LEVEL will not be remembered.
- The Soak, Wash, Rinse and Spin for ECO program will be remembered.

CHILD LOCK FUNCTION

The washer will stop working automatically and alarm if washer lid opened 5 seconds during operation.

Method of Child Lock Set:

- Press POWER ON/OFF button, press WATER LEVEL button for 4 seconds till Buzzer sounds. To restore it, repeat above or unplug.

If you set the Child Lock function, the other buttons will not respond.

Note: This function cannot be stored.

CANCEL THE END BUZZER

- Press POWER ON/OFF button to switch on the power, and press START/PAUSE button for 4 seconds till a sound comes from buzzer. To restore it, repeat above or unplug.

Note: This function cannot be stored.

POWER DISSOLVE

Power Dissolve Case has two parts, Detergent Case & Solution Case.

POWER DISSOLVE process as follow:

1. Put wash powder into Detergent case.
2. Gentle water current will be injected into the Detergent case. The detergent will enter into solution case evenly and slowly. This process will last around 1 minute.
3. Strong water current will be poured into the Solution Case to dissolve the detergent.
4. In this case, the detergent that enters into the tub has been dissolved in the solution case. This technology generate bubbles by dissolving detergent, and quickly absorbed by fabrics to enhance the cleanliness.

Note: This is a default function, setting is not available.

Note: Suitable for detergent powder only.

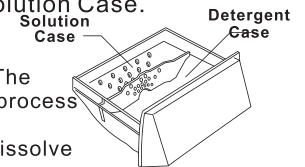

TROUBLE SHOOTING GUIDE

When the following problems occur, the microcomputer will detect the abnormal condition and an electronic buzzer sounds for approximately 10 seconds and the indicators flash as shown below. At the same time, the washer stops operation.

Kind of Trouble	Trouble Indication	Where to Check
The washer does not work at all.		<ul style="list-style-type: none"> • Press the POWER ON/OFF button. • Press the START/PAUSE button. • Check whether power failure occurs. • Check whether the fuse or circuit breaker has been activated.
Water does not flow into the Wash/Spin Tub.	E1	<ul style="list-style-type: none"> • Turn on the water supply faucet. • Check whether the water supply has been cut off. • Check whether the metal filter of the water inlet is clogged. • Check whether the water inlet has been blocked or frozen. • Check whether water pressure is too low.
Water does not drain out.	E2	<ul style="list-style-type: none"> • Check whether the height of drain hose is more than 1000mm . • Check whether the drain hose is clogged.
The washer does not spin.	E3	<ul style="list-style-type: none"> • Check whether the laundry is clumped on one side of the Wash/Spin Tub. • Check whether the washer is on the level surface.
	E4	<ul style="list-style-type: none"> • Close the washer lid.
The buzzer keeps beeping.	E5	<ul style="list-style-type: none"> • Check whether the CHILD LOCK is set. • Close the washer lid.
Other troubles.	EA	<ul style="list-style-type: none"> • Press the POWER ON/OFF button to turn off the power, call your service-person or dealer.
	EC	

NOTE: The trouble indicators can be released by pressing the START/PAUSE button once if you want to release the emergency stop. Then press the START/PAUSE button again to restart the operation.

NOT FAILURE INDICATION



1. During washing or rinsing, there is still water inletting. This is possibly automatic water adding due to water level decrease.
2. Spin tub turns or stops timely at the beginning of spinning. This is intermittent spinning for better spin effect.
3. Water is inletting and rinsing sometimes during spinning. This is automatic lean-correction due to clothes is not placed evenly inside.
4. There is sound like water flow after spinning. This is the sound of balance liquid in balance ring. It is for reducing vibration of spinning.
5. Control panel keeps warm after power off, this is caused by remembering circuitry working.
6. Power off during working and the washer could not continue working. Please set the program again.

目錄







注意事項	20-22
保養須知	22
附件說明	23
各部件名稱	23
安裝指引	24-28
功能介紹	29-30
一般的使用方法	31
選擇“程序”、“過程”的使用方法	32-33
洗衣前準備事項	33
其他功能介紹及設定方法	
• 洗滌毛毯	33
• 雙水位設定	34
• 雙重強力洗	34
• 記憶功能	34
• 兒童鎖功能	34
• 取消蜂鳴提示	34
• 即溶淨	34
故障排除指南	35
並非故障的情況	36
規格	37

注意事項

- 使用前詳細閱讀「注意事項」並正確使用。
- 為了防止對使用人和他人造成傷害或財產損壞，現就安全方面需要務必遵守的事項，作如下說明。

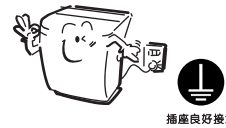
 警告	此標示欄的內容為「有死亡或受傷的可能性」。
 注意	此標示欄的內容為「有受傷及僅有物品損壞的可能性」。

		
「警告或提醒注意」的內容。	「禁止」的內容。	「注意」的內容。

 警告	
<p> 不可改裝，非專業維修人員禁止拆解及修理洗衣機。</p> <ul style="list-style-type: none"> • 這會造成火災、觸電、受傷。 	<p>請務必正確接地。</p> <ul style="list-style-type: none"> • 為防止漏電事故的發生。  <p style="text-align: right; font-size: small;">插座良好接地</p>
<p>手潮濕時請勿插入或拔下電源線插頭。</p> <ul style="list-style-type: none"> • 以避免觸電的危險。  <p style="text-align: right; font-size: small;">禁止濕手</p>	<p>洗衣機本體各部分，請勿直接用水沖洗。</p> <ul style="list-style-type: none"> • 以避免絕緣不良，導致觸電的危險。  <p style="text-align: right; font-size: small;">禁止</p>
<p>電源線的保護。</p> <ul style="list-style-type: none"> • 使用時請注意電源線外皮是否受損傷，有無不合理彎曲或拉伸及重物壓住變形等現象，電源線破損導致絕緣不良，這是發生觸電、火災的原因。電源線損壞時，需由專業維修人員維修更換。  <p style="text-align: right; font-size: small;">禁止</p>	<p>請勿洗滌沾有揮發性溶劑的衣物。</p> <ul style="list-style-type: none"> • 請勿洗滌沾有汽油、煤油、稀釋劑等的衣物。這樣可能引起火災或爆炸。  <p style="text-align: right; font-size: small;">禁止</p>

注意事項

警告

不要讓兒童在洗衣機上或洗衣/脫水桶內玩耍。

- 如果兒童不慎掉入洗衣/脫水桶內，會產生嚴重的傷害。
- 該電器不適用於(包括兒童)：具有身體障礙、感官障礙、精神障礙者，或缺乏必要經驗與常識者，必須要在安全監護人的指導和監督下才可以使用。



- 不要將手伸進洗衣/脫水桶內直至機器停止運轉。即使內桶旋轉緩慢但是仍有危險，導致人體受傷。尤其當兒童在周邊的時候一定要特別注意。
- 不要在洗衣機洗衣或漂洗過程中將手放入洗衣/脫水桶內。即使旋轉速度很慢，但是手仍然會被衣服纏住。如有必要請按暫停鍵，等機器徹底停止旋轉後再將手伸進桶內。



勿過度彎曲、拉扯、扭轉電源線。

- 會造成電源線破損導致火災、觸電。

電源線插頭的灰塵等要定期清除。

- 電源線插頭上若灰塵堆積，會因濕氣造成絕緣不良引起火災。



避免安裝於潮濕及雨淋處。

- 電器絕緣不良，成為漏電或故障的原因。



請勿靠近煙火。

- 請勿靠近煙火，且勿將點燃的蠟燭、香煙、蚊香及水壺放在洗衣機上，這是造成火災及變形的主要原因。



注意

- 電源線插頭插入或拔出時，手指須緊握插頭絕緣部份施力，請勿觸碰插頭的金屬插片，以避免觸電或施力於導線端，導致電源線內部導線斷裂。
- 在移動洗衣機時，務必先拔下電源線插頭。



- 長時間不使用洗衣機時，請拔掉電源。可能會因為漏電或者觸電造成塑料件變形。
- 如果電源線損壞，為了避免危險，必須由生產商、其代理商或相關的合格人員替換。

- 熱水會使塑料部件變形，這是發生故障的原因。



注意事項

注意

防水性或不吸水的洗滌物不可以放在洗衣機內洗滌。

- 以避免洗衣機或脫水時，產生異常震動。(如雨衣、車套)

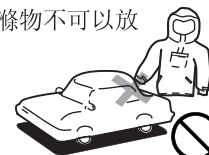

請勿將幼兒或重物放置在洗衣機上。

- 以避免部件變形或破損導致危險的發生。



洗衣機運轉中，請切勿嘗試接觸內部運動部件。

- 以避免受傷的危險。



- 供水管應擰緊，否則可能會導致漏水。水管接口處長時間使用可能會導致螺母鬆動造成漏水，請檢查時再次擰緊。



- 洗滌之前檢查供水軟管連接處。螺釘鬆開或不緊密可能造成漏水。
- 請使用隨機附上的新的軟管裝置，舊的軟管裝置不可重複使用。
- 如洗衣機安放在鋪有地毯的地板或彈性較大的支撐台上時，可能會造成洗衣機的震動。



注意

- 洗衣機不使用時，應關閉水龍頭，以避免進水軟管破損或脫落，造成漏水事故的發生。
- 應將電源線插頭拔掉，以防止發生火災或其他事故。



保養須知

使用軟布擦拭箱體上的水及污跡。

- 不要將水直接潑灑在箱體上，這樣做可能會造成短路或觸電。
- 不要使用刷子、上光粉、汽油或其他易揮發性材料擦拭洗衣機。這樣做可能會損壞機身表面塗層或塑料部件。



進水閥口的清理 (建議半年一次)。

- 髒物積存會影響進水量，請取下進水軟管，取出進水閥口的過濾網，清除網上的髒物後重新裝回去。



進水閥口

接頭的清洗 (建議半年一次)。

- 取下進水軟管。
- 按箭頭方向旋下接頭。
- 將清洗乾淨的接頭、進水軟管重新裝上。







過濾網的清洗 (建議每次使用後)。

- 取下過濾網。
- 去除大塊毛絨，同時刷去過濾網上的細小絨屑。
- 重新裝上過濾網，安裝時將框部的爪對準下方的溝部放入。(過濾網為易損部件)

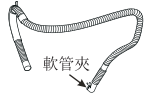

附件說明

說明書 (一本)	排水軟管組件 (一根)	進水軟管 (一根)	防鼠板 (一個)	螺釘 (一個)
				

各部件名稱

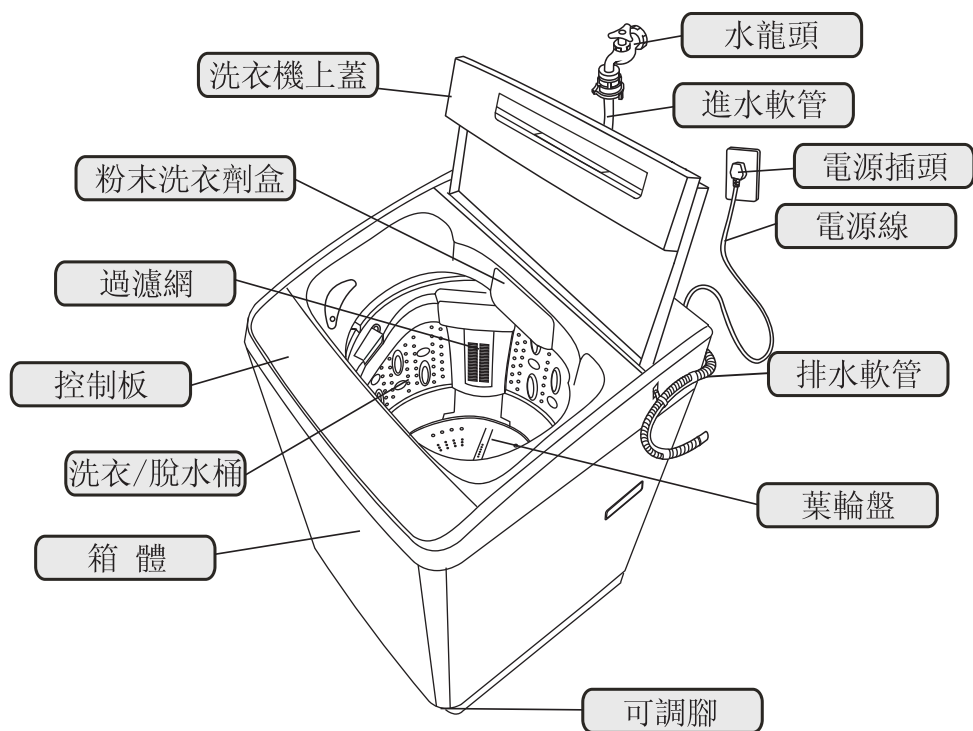

安裝指引

防鼠板的安裝

1. 拿出洗衣機面架保護上的防鼠板和部件袋中的螺釘。
2. 將洗衣機向後傾斜，慢慢地放在軟墊上（小心不要磕碰箱體）。
3. 將防鼠板沿底托卡槽筆直推入，直到其安裝到位。
4. 用螺釘將防鼠板與底托固定。
5. 將洗衣機輕輕扶起，放穩。

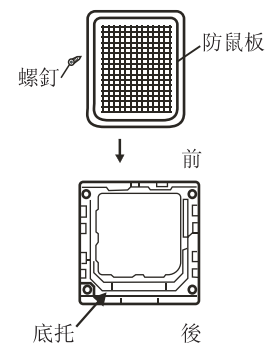

洗衣機的放置

1. 選擇乾燥、無陽光直射的地方放置洗衣機。
2. 將洗衣機安放在堅實、平穩的地面上。



3. 儘量使洗衣機平穩，如有必要，可通過調節洗衣機的可調腳來將洗衣機調平。
 - 支撐面最大允許傾斜度為 2° 。

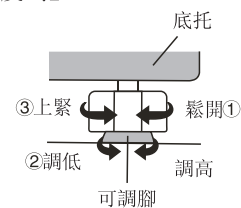

注意:

- 不要讓地毯等鋪墊物堵塞洗衣機底部的散熱孔。

安裝指引

進水軟管的安裝

1. 請檢查密封圈是否良好的固定在軟管的接頭上。
2. 將進水軟管彎曲的一端連接在洗衣機的進水閥上，用手擰緊進水軟管上的旋緊螺母。
3. 將進水軟管直的一端連接在水龍頭上，並用手擰緊進水軟管上的旋緊螺母。
4. 打開水龍頭，檢查是否有漏水。如果水管的一端有漏水，請將那端的旋緊螺母擰緊。如果水壓比較大，請關閉水龍頭，然後再緩緩的打開。

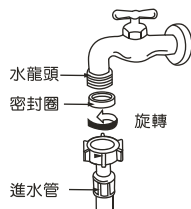

注意:

- 請不要使用水溫超過50℃的水。
- 如果您的水龍頭的水管不相配，請聯繫經銷商。

將進水軟管連接到洗衣機進水閥

按右圖所示，將進水軟管口對準進水閥口，順時針旋轉進水軟管上的旋緊螺母，直至旋不動為止。

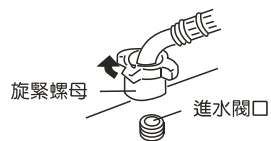

按右圖所示，進水閥上的進水軟管按逆時針方向旋轉，直至取下進水軟管。

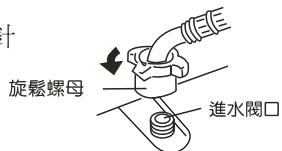

安裝指引

適用於高去水位安裝

排水軟管的安裝

1. 將排水管連接到箱體背後的排水接頭上。
2. 連接好後，請用軟管夾子將排水管夾緊，應切實的插入到位，以免漏水。

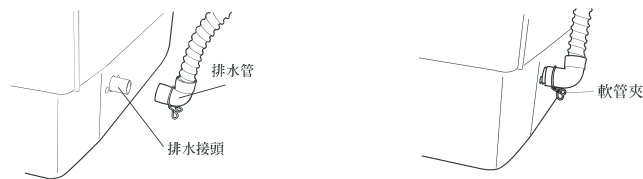

3. ① 將排水管固定架插入孔中。
② 按圖示方向旋轉90度，將固定腳旋入孔中。

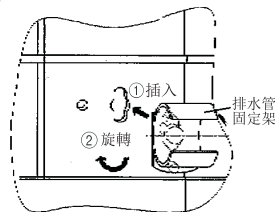

4. 將排水管拉直，嵌入固定在排水管固定架上。

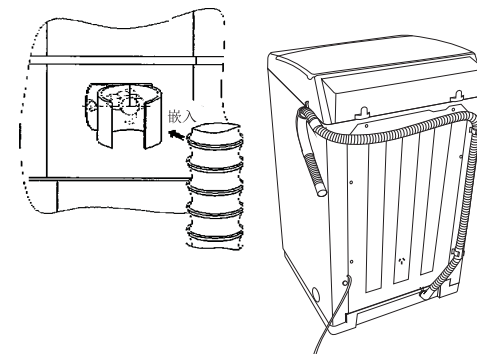

安裝指引

注意：

- 請勿將排水管放倒，以免水灑落。
- 請勿使用延長排水管。
- 請勿將排水管尾部的U型管浸在水中。
- 排水管安裝時，請勿低於排水接頭，如低於排水接頭可能會導致排水不順。

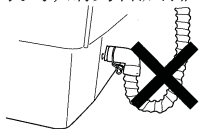

- 洗衣機操作時，排水軟管掛起的高度必須低於1000mm，否則洗衣機可能無法正常工作。

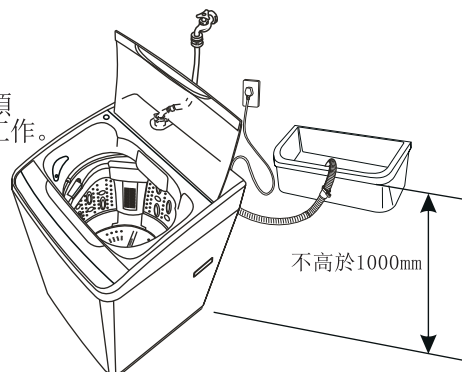

安裝指引

適用於低去水位安裝

排水軟管的安裝

1. 捏緊排水軟管夾子上的兩個柄，將排水軟管連接到排水泵口上（洗衣機後部）。然後用軟管夾子將其固定。

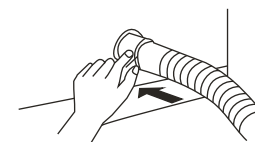
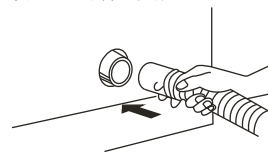

2. 將排水軟管另一端向上提起，按順序把排水軟管扣在洗衣機背部的卡扣內。
3. 在不用洗衣機的時候，將排水軟管的口部一端掛在洗衣機面架右側的小孔內。在使用洗衣機時，請將排水軟管口放在下水道口。

功能介紹

數碼窗

- 在程序進行過程中，數碼窗顯示整個過程的剩餘時間。
例：剩餘時間為20分鐘 **20**
- 在預校設置時，數碼窗顯示預校程序何時完成。
例：2小時後完成 **2**
- 在設定過程中，該數碼窗顯示設定的時間或次數。
例：2次過水 **2**
- 當非正常情況發生時，該數碼窗顯示故障代碼。
例：進水異常 **E1**

“程序”鍵

- 按“程序”鍵選擇您所需要的程序，然後相應的燈點亮。

“啟動/暫停”鍵

- 按下“電源開/關”鍵，接通電源後，按該鍵，洗衣機開始運轉。
 - 該鍵亦可用於暫時停止運轉。要重新開始運轉，只需再按“啟動/暫停”鍵。
- 注意：**
- 該鍵並不是取消鍵。
 - 用該鍵可以關掉程序完結時的蜂鳴提示。

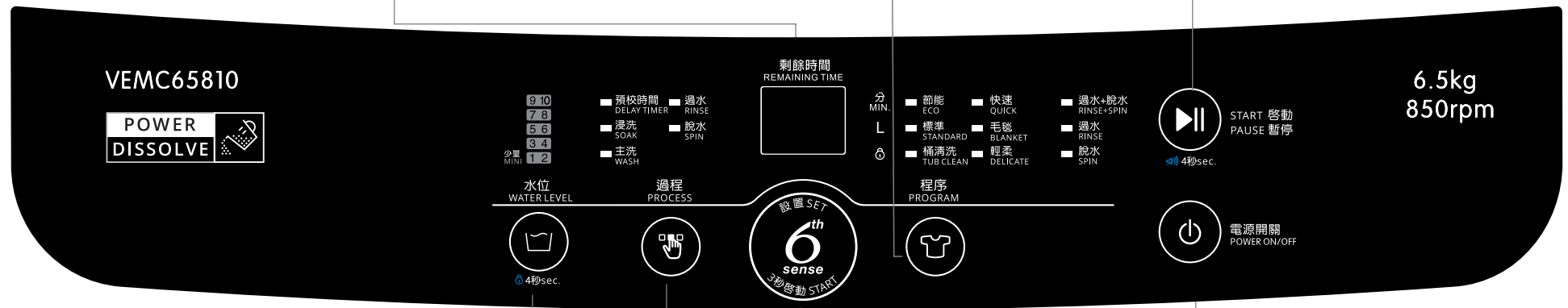

“水位”鍵

- 通過該鍵選擇洗衣量相對應的水位。
- 主洗和過水可以用不同的水位。
- 可設置兒童鎖功能，詳情參見34頁“其他功能”介紹中兒童鎖安全鎖的功能。

“過程”鍵

您可以根據需要，通過該按鍵結合“6th sense”鍵自由設定預校時間、浸洗、主洗、過水、脫水功能。如設置過水次數：按“過程”鍵直至過水燈閃爍，然後按“6th sense”鍵選擇您想要的過水次數。

“6th sense”鍵

- 在通電狀態下，可以通過長按“6th sense”鍵三秒開始運行標準的洗滌程序。
- 在通電狀態下，按下“電源”鍵，再按“過程”鍵至相應功能指示燈閃爍，然後按該鍵設定預校時間、浸洗時間、主洗時間、過水次數和脫水時間。

“電源開/關”鍵

- 要接通洗衣機電源，請按“電源開/關”鍵。如關閉電源，再按該鍵一次即可。程序完成時，電源會在5秒之後自動關閉。
- 注意：**
- 程序啟動後如想改變當前的洗衣程序，請關上“電源開/關”並重新啟動。
 - 如果您按下“電源開/關”鍵後再沒有按壓其他鍵，電源將會在10分鐘內自動關閉。

一般的使用方法

1. 使用洗衣機前準備及步驟。

- ① 接好並放下排水軟管。
- ② 將進水軟管接到水龍頭上，並擰開水龍頭。請確認進水管接頭的螺釘已擰緊。如果螺釘鬆動，可能會造成漏水。
- ③ 將電源插頭插入電源插座。
- ④ 放入洗衣物。

2. 按“電源開/關”鍵。

3. 按“啟動/暫停”鍵。

- 洗衣機將自動檢測衣物量（“標準”、“節能”程序時），自動選擇水位，水流，洗衣脫水時間，過水方式等。
- 如最低兩檔水位不能自動選擇，需要時，可人手設定。

4. 將洗滌劑放入洗衣劑盒或洗衣/脫水桶內。

5. 蓋好洗衣機上蓋。

水位(檔)	1	2	3	4	5	6	7	8	9	10
水量(L)	約15	約18	約21	約24	約28	約32	約38	約42	約45	約50

注意：

- 若使用柔順劑，可在洗衣前向柔順劑入口處倒入適量的柔順劑。
- 放入太多的洗衣劑，可能影響到過水性能，太少的洗衣劑可能影響到洗衣效果。

選擇“程序”、“過程”的使用方法

1. 準備：放好排水管，擰開水龍頭，將電源插頭插入電源插座，放入洗衣物。

2. 按一下“電源開/關”鍵。

3. 根據所洗衣物的種類，按“程序”鍵設定您想要的程序。

各程序的選用參見下表：

選擇“程序”、“過程”的使用方法

各程序的選用指導

程序	洗滌水流	衣物的種類
標準	標準	一般骯髒、需要經常更換的衣物(適用於日常洗滌)
節能	標準	節省能源的洗滌程序(用於設定節電測試用途)
桶清洗	強	清潔洗衣桶，保持衛生，避免二次污染
毛毯	標準	毛毯或大型衣物
輕柔	輕柔	女性內衣、飾有花邊和刺繡的衣物
快速	標準	穿著時間短而不太骯髒的衣物
過水+脫水	-	僅需過水脫水的衣物
過水	-	僅需過水的衣物
脫水	-	僅需脫水的衣物

4. 按“過程”鍵，自由選擇浸洗、主洗、脫水的時間，過水次數。

預校時間設定顯示：0→1→2……→5→6……24 小時（“輕柔”模式不能設定“預校”功能）

↑

• 浸洗時間設定顯示：0→5→10→15→……40 分鐘（“輕柔”、“毛毯”程序時無此功能）

↑

• 主洗時間設定顯示：0→1→2→……9→10→……20 分鐘

↑

• 過水次數設定顯示：0→1→2→3→4 次

↑

• 脫水時間設定顯示：0→1→2→……5→6→……9 分鐘

↑

0→1→2→3 分鐘（“輕柔”程序）

↑

• “過水”+“脫水”，過水、脫水程序只可設置過水/脫水參數。

5. 按“水位”鍵，選擇必要的水位，放入洗衣劑。

6. 按“啟動/暫停”鍵。

7. 蓋好洗衣機上蓋。

- 如果您想改變已設定好的“程序”及“過程”選擇。請關掉電源開關，然後再開啓，並重新選擇您所需要的程序。

選擇“程序”、“過程”的使用方法

各程序預設的運行情況			
程序	洗衣時間(分鐘)	過水次數	脫水時間(分鐘)
標準	5~12	過水二次	4~6
桶清洗	20	過水一次	9
輕柔	6	過水二次	2
毛毯	12	過水二次	8
節能*	10	過水二次	5
快速	5	過水一次	3
過水+脫水	-	過水一次	5
過水	-	過水一次	-
脫水	-	-	5

*能源效率檢測程序（經設定後的水位，主洗時間，過水次數，及脫水時間）
·各程序運行的合計時間因水壓不同而有所變化。

洗衣前準備事項

- 確保衣服口袋內沒有物品。（如釘子、硬幣等可能損傷衣服或洗衣機，產生額外的噪音或使洗衣機發生故障的東西。）
- 將衣服翻過來洗，這樣洗衣過程中產生的線屑不會附著在衣服表面。
- 當清洗纖細織物時，如女性內衣、飾有花邊的物品、尼龍和、薄化織衣料等，應將其放入洗滌用網套中。
- 繫緊衣服上鬆的帶子並拉上拉鍊，扣好鈕扣。
- 洗滌前先去衣物上的泥土和沙。建議在洗較髒的外套前用刷子先洗刷一下。
- 易浮於水面之上的衣物，請放入水底，另外，浮上來時，請暫停並將其按入水中。
- 請將厚物與薄的衣物分開洗滌，有色衣物與白色衣物分開洗滌，外衣與內衣、毛巾等分開洗滌。

其他功能介紹及設定方法

洗滌毛毯

1. 接通電源，放好排水管。
2. 擰開水龍頭，按“程序”鍵直至“毛毯”燈閃爍。
3. 將洗衣劑用5L的溫水（約30°C）充分溶解後，放入洗衣/脫水桶內。
4. 將毛毯按以下方法卷好後，放入洗衣/脫水桶內。
5. 按“啟動/暫停”鍵。
6. 蓋好洗衣機上蓋。



將毛毯沿長度方向對摺



再在同一方向摺成4層

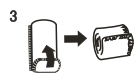

將毛毯卷起



將有邊的一方朝下放入洗衣/脫水桶內

其他功能介紹及設定方法

雙水位設定

爲了提高洗衣劑濃度，同時也可以節約用水，主洗、過水可以設定不同的水位，建議以較低的水位洗滌，較高的水位過水，這樣可以保證洗得乾淨，過得徹底。

設定方法

按“過程”鍵直到“主洗”燈閃爍，按“水位”鍵選擇合適水位，按“6thsense”鍵設置主洗時間。然後再按“過程”鍵直到“過水”燈閃爍，再按“水位”鍵選擇合適水位，按“6thsense”鍵設置過水次數。然後按“過程”鍵直到“脫水”燈閃爍，按“6thsense”鍵設置脫水時間，然後按“啟動/暫停”鍵，機器將按用戶設置的主洗水位和過水水位來開始運轉。

雙重強力洗

在洗衣過程中，洗衣機在達到比設定水位低兩檔水位時，進水同時開始洗滌。

· 設定最低兩檔水位時，達到設定水位後開始洗滌。

“輕柔”、“毛毯”程序沒有雙重強力洗功能。

· 選擇“浸洗”時，浸洗結束後洗滌時沒有雙重強力洗功能。

注意：此為內置功能，無法設定。

記憶功能

當選擇“標準”、“節能”程序的時候，啟動後15秒，機器將自動記憶此程序並在下一次啟動工作時，按照此設置來運轉。

· 該功能不適用於“輕柔”、“毛毯”、“桶清洗”、“快速”、“過水+脫水”、“過水”、“脫水”。

· 預校時間和水位不能被記憶。

· “節能”程序中的浸洗、主洗、過水和脫水可以記憶。

兒童鎖功能

設定兒童鎖功能後，在運行過程中打開洗衣機上蓋5秒以上，洗衣機將停止工作並發出提示警報。

· 兒童鎖功能的設定：啟動“電源開/關”，按“水位”鍵4秒以上，直至聽到蜂鳴提示：取消時，重覆上述步驟，或拔掉電源插頭。

設置兒童鎖功能啟動後，所有按鍵都不反應。

注意：此功能無法儲存。

取消蜂鳴提示

· 取消蜂鳴提示的設定：啟動“電源開/關”，按“啟動/暫停”鍵4秒以上，直至聽到蜂鳴提示：恢復時，重覆上述步驟。

注意：此功能無法儲存。

即溶淨

即溶淨洗衣劑盒分兩部份，洗衣劑盒及溶劑盒

使用即溶淨步驟如下：

1. 將洗衣粉放入洗衣劑盒內。

2. 清水便注入洗衣劑盒內，並平均地慢慢流入溶劑盒內。過程若需1分鐘。

3. 較大的水流會注入溶劑盒內，把洗衣粉溶於水裡。

4. 洗衣劑溶於水後，溶解後的洗衣劑會流入洗衣桶內。此技術能產細膩的泡沫，並迅速地平均滲透衣物纖維，有效地提高潔淨效能。

注意：此為內置功能，無法設定。

注意：只適用於洗衣粉。

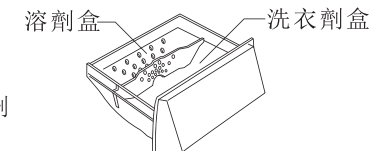

溶劑盒

洗衣劑盒

故障排除指南

當下列問題出現時，微電腦將對不正常狀態進行檢測，並發出大約10秒鐘的蜂鳴提示，數碼窗將按下表所示狀態閃爍。

故障類型	故障顯示	原因
完全不運轉		<ul style="list-style-type: none"> · 是否停電。 · 電源開關是否接通。 · 是否按了“啓動/暫停”鍵。 · 電源的保險絲或電路的電流斷路器是否完好。
不進水或進水量很少	E1	<ul style="list-style-type: none"> · 水龍頭是否打開。 · 是否停水。 · 過濾網是否被堵塞。 · 洗衣機進水管是否已被堵塞或結冰。 · 水壓是否太小，長時間進水未達到設定水位。
不排水	E2	<ul style="list-style-type: none"> · 排水管是否過高(超過1米)。 · 排水管是否被堵塞。
不脫水	E3	<ul style="list-style-type: none"> · 洗滌物是否偏向洗衣桶一側。 · 洗衣機安放是否平正。
	E4	<ul style="list-style-type: none"> · 洗衣機上蓋是否打開。
不洗滌	E5	<ul style="list-style-type: none"> · 檢查兒童鎖模式是否設置。 · 洗衣機上蓋是否打開。
其他	EA	<ul style="list-style-type: none"> · 請按“電源開/關”關閉電源，並盡快撥打本公司客戶服務熱線。
	EC	

注意：按“啓動/暫停”鍵，故障顯示被解除。如您檢查各項並排除故障後，再按“啓動/暫停”鍵，洗衣機將繼續運轉。

並非故障的情況

1. 主洗或過水時，有時有進水現象，這是水位下降而進行的自動補水。
2. 在脫水開始時，脫水桶時停時轉，這是為達到更好的脫水效果而設計的間歇脫水。
3. 脫水中途有時出現過水現象，這是由於脫水時衣物偏置，而自動進行的脫偏糾正。
4. 脫水結束後，有水殘留的聲音，這是為了降低脫水震動而設計的平衡環內平衡液的流動聲。
5. 在運轉後關掉“電源開/關”，控制板部份仍可以感覺到輕微發熱，這是由於記憶電路電子部件發熱造成的。
6. 程序運行中停電，來電後不能繼續運行，請重新設定。

SPECIFICATIONS

規格

Dimensions 尺寸	520(W)x545(D)x910(H)mm(VEMC65810) (闊) (深) (高)
Weight 重量	34.5kg
Water quantity (HIGH) 水量 (高水位)	50L
Voltage 額定電壓/頻率	AC 220V ~ 50Hz
Input Power 額定輸入功率	330W
Required Water Pressure 水壓	0.03 MPa – 0.8 MPa

FOR WASHER WITH A 13 Amp. PLUG TOP 3 PIN
對於附有13安培三腳插頭的洗衣機

WARNING - This appliance must be earthed.
警告-本電器必須接地。

IMPORTANT

The wires in this mains lead are coloured in accordance with the following code:

Green/Yellow: Earth
Blue: Neutral
Brown: Live

As the colours of the wires in the mains lead of this appliance may not correspond with the coloured markings identifying the terminals in your plug, proceed as follows:

The wire which is coloured green and yellow must be connected to the terminal in the plug which is marked with the letter E or by the earth symbol , or coloured green or green and yellow.

The wire which is coloured blue must be connected to the terminal which is marked with the letter N or coloured black.

The wire which is coloured brown must be connected to the terminal which is marked with the letter L or coloured red.

重要事項

電源線的電源是根據以下的顏色表示:

綠 黃:地線
藍 :中性線
棕 :火線

由於本電器電源線的顏色不一定和您的插頭終端上的顏色標誌相同, 所以應該採取以下步驟:

綠黃色電源線應該連接至插頭上標明英文字母 E 或地線符號 , 或顏色是綠色或黃綠色的終端。

藍色電源線應該連接至插頭上標明英文字母 N 或顏色是黑色的終端。

棕色電源線應該連接至插頭上標明英文字母 L 或顏色是紅色的終端。